

1 9 2 4  
**100**  
2 0 2 4

---



**TOSELLO**

---

20 Product  
24 catalogue

# Sprayer line

Tosello sprayers cater to your crop treatment needs. They range from the simplest units — a versatile and cost-effective manual-fold boom option — to more complex machines designed to meet the needs of professionals demanding nothing but the best. The technical solutions adopted result in reliability and longevity, as well as successful outcomes for you in the field.

# Silver



Extremely light and versatile linkage sprayer, suitable for jobs on small and mid-sized plots. It comes with a manual-fold boom with a working width ranging from 3.5 to 16 metres depending on the version. It can also be fitted with the ZC-Pro-series booms on request, see page 19.

### Technical specifications

- Hot-dip galvanized frame and boom
- Polyethylene handwash and system rinse tank
- Low-pressure pump
- In-tank agitator
- Constant-pressure manual valve bank



L

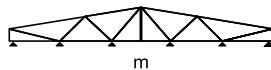

m



L / m

400	6 - 8 - 10 - 12	80-135
500	6 - 8 - 10 - 12	80-135
600	6 - 8 - 10 - 12	80-135
800	12 - 14 - 15 - 16	135-160
1000	12 - 14 - 15 - 16	135-160

• PTO shaft and tank-filling system available to order.

# Gold Horti



Linkage sprayer designed to cater to the requirements of greenhouse vegetable growers. Its distinguishing feature is the asymmetrical weed spray boom, which allows herbicides to be applied while working around the raised row layout typically associated with greenhouses. It comes in one size with a coverage of 7.5 m, and 25cm or 50cm nozzle spacing.

## Technical specifications

- Hot-dip galvanized frame and boom, two-cylinder opening/closing
- Polyethylene handwash and system rinse tank
- Low-pressure pump
- In-tank agitator
- Constant-pressure manual valve bank or electric version with in-cab control box

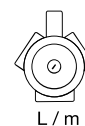
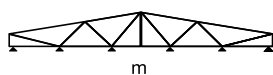

L	m	L / m
400	7.5	160
500	7.5	160
600	7.5	160

• PTO shaft and tank-filling system available to order.



# Gold L2



Youtube



**Professional linkage sprayer for medium-large farms. It is just the right compromise between affordability and a quality product. This type of unit has a tank capacity ranging from 400 to 600 litres, and features an L2 hydraulic weed spray boom measuring between 6 and 12 metres in width.**

**It can also be fitted with numerous optional extras.**

**The Gold L2 models come as standard with Annovi Reverberi pumps with a flow rate of 135 l/min.**

**On request, it can be fitted with a 160 l/min pump (recommended when ordering the optional pre-mixer).**

## Technical specifications

- Hot-dip galvanized frame and boom, two-cylinder opening/closing
- Polyethylene handwash and system rinse tank
- Low-pressure pump
- In-tank agitator
- Constant-pressure manual valve bank or electric version with in-cab control box



L



m



L / m

L	m	L / m
400	6 - 8 - 10 - 12	135-160
500	6 - 8 - 10 - 12	135-160
600	6 - 8 - 10 - 12	135-160
800	8 - 10 - 12	135-160
1000	8 - 10 - 12	135-160

• PTO shaft and tank-filling system available to order.



# Gold P2



Youtube



**Model specially designed to cater to the requirements of medium-large farms, and contractors. It features P2-series booms with self-levelling and mechanical auto lock, or with tilt correction cylinder.**

**This machine has a wide range of accessories to choose from to meet individual requirements, in addition to numerous solutions for precision agriculture; see the kit options on page 17.**

### Technical specifications

- Hot-dip galvanized frame and boom, two-cylinder opening/closing
- Polyethylene handwash and system rinse tank
- Low-pressure pump
- In-tank agitator
- Electric valve bank with in-cab control box
- 25/40L pre-mixer



L



m



L / m

L	m	L / m
800	10 - 12 - 14 - 15	160
1000	10 - 12 - 14 - 15	160
1200	10 - 12 - 14 - 15	160



# Platinum

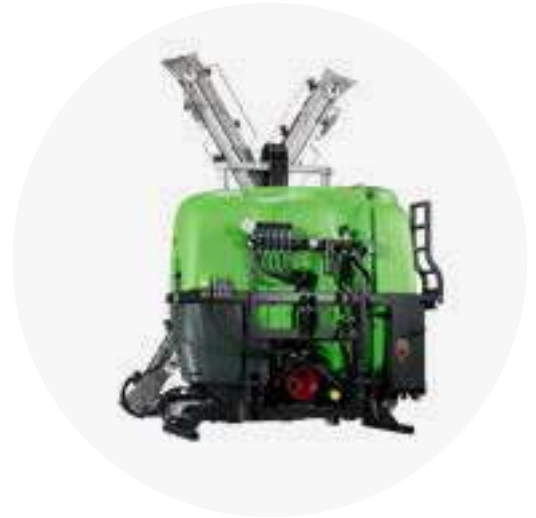

The Platinum professional range caters to the demands of large farms, and contractors. It features P2-series booms with self-levelling and mechanical auto lock, or with tilt correction cylinder. The unit, designed for the most demanding customer, comes as standard with all the instruments required to make your job easier, while a lot of work has gone into developing its ergonomically designed controls. It can be ordered as an ISOBUS-ready implement.

### Technical specifications

- Coated frame and hot-dip galvanized boom, two-cylinder opening/closing
- Polyethylene handwash and system rinse tank
- Low-pressure pump
- In-tank agitator
- Electric valve bank with in-cab control box
- System rinsing without diluting product in tank
- pre-mixer



L

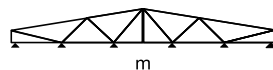

m



L / m

L	m	L / m
800	10 - 12 - 14 - 15	160
1000	10 - 12 - 14 - 15	160
1200	10 - 12 - 14 - 15	160

• PTO shaft and tank-filling system available to order.



# Accessories

- Powder pre-mixer with container rinser
- 6m tank filler hose kit with floating filter
- Foam marker kit
- Rear lights kit
- Toolbox
- HRGeo 70L hose reel (PVC hose on request)
- PTO shaft 2 x 900
- Rotating tank rinser
- Solenoid valve kit 3-section oil
- Solenoid valve kit 4-section oil
- Castors (for Platinum only)

## Lifts

- Lift winch for L2 boom
- Lift winch for P2 boom
- Self-levelling kit with mechanical system or hydraulic ram (for L2 and manual-fold booms)
- Manual boom-lift kit (for L2 and manual-fold booms)
- Hydraulic lift kit for L2 booms
- Hydraulic lift kit for P2 booms (option with leaf spring suspension)
- Hydraulic lift kit with airbag suspension for P2 booms

## Precision agriculture

- Bravo 180S computer
- Bravo 180S computer + 3-section oil
- Bravo 180S computer + 4-section oil
- Bravo 400S computer
- Bravo 400S computer + 3-section oil
- Bravo 400S computer + 4-section oil
- ISOBUS kit 5-section water
- ISOBUS kit 5-section water + 4-section oil
- Virtual terminal application for non-ISOBUS tractor

### Bravo 180

Compact computer, at once affordable, effective and accurate, suitable for small-medium farm machinery. The readings that can be displayed are dose rate, speed, pressure, flow rate, sprayed quantity, tank level, surface area treated, spraying time, and distance covered. It can be supplied complete with a physical keypad for hydraulic functions.

### Bravo 400S

Bravo 400S is the professional computer that incorporates all liquid distribution and navigation management functions. Manages automatic section folding





# ZC/ZF manual-fold weed spray boom



**ZC/ZF-series booms are sturdy while providing good stress resistance. They have a quality tubular construction and stand out for their reliability and stability during use, ensured by the spring-loaded break-back.**

**They are used by our customers in the garden sector – with the smallest booms applied directly to UTVs such as quad bikes and golf carts – as well as by farmers for field spraying of herbicides.**

**Transport width is still less than 2.5 metres, meaning they are in line with current road regulations.**

**Universal mounting kit available on request.**

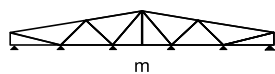

Galvanizing  
type

3.5	300 x 180 x 1500	15	ZF (zinc-plated)	
4.5	300 x 180 x 1500	16	ZF (zinc-plated)	
6	300 x 200 x 2000	19	ZF (zinc-plated)	
8	350 x 250 x 2100	41	ZF/ZC (zinc-plated/hot-dip)	
10	350 x 250 x 2100	46	ZF/ZC (zinc-plated/hot-dip)	
10P	680 x 330 x 2100	60	ZC (hot-dip)	
12	680 x 330 x 2500	78	ZF/ZC (zinc-plated/hot-dip)	
12S	850 x 330 x 2100	70	ZC (hot-dip)	
12N	400 x 300 x 2470	90	ZC (hot-dip)	
14	750 x 450 x 2500	147	ZC (hot-dip)	
15	750 x 450 x 2500	152	ZC (hot-dip)	
16	750 x 450 x 2500	157	ZC (hot-dip)	

# ZC-Pro manual-fold weed spray boom



Originally custom designed for one of our customers, this has become a standard model due to the technical solutions implemented in its design: sturdy, strong and, above all, with the bonus feature of using the actual structure to shield the nozzles so that they cannot be broken by accident. The narrower widths are ideal for jobs on parks, golf clubs, and sports grounds in general, while the larger versions are used for field spraying. Universal mounting kit available on request. Because this is a premium product, it only comes with the hot-dip galvanized treatment.

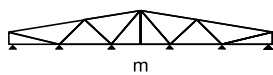

		kg
3.5	300 x 300 x 1210	20
4.5	300 x 300 x 1522	22
6	300 x 300 x 2062	25
8	300 x 300 x 2062	50
10	300 x 300 x 2062	52

# L2 hydraulic weed spray boom



Youtube



The L2 model, which has been tried and tested over the years and features a high level of reliability, is our entry-level hydraulic boom. Opening and closing is achieved, on each side, by a hydraulic cylinder and a tie rod: there is a clear benefit to this system, requiring just two double-acting hydraulic couplers to operate the unit. A question of practicality.

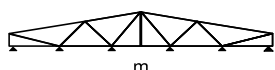

6	2000 x 150 x 2100	60	
8	1500 x 400 x 2100	120	
10	1900 x 400 x 2100	133	
12	2300 x 400 x 2100	146	



# P2 hydraulic weed spray boom



Youtube

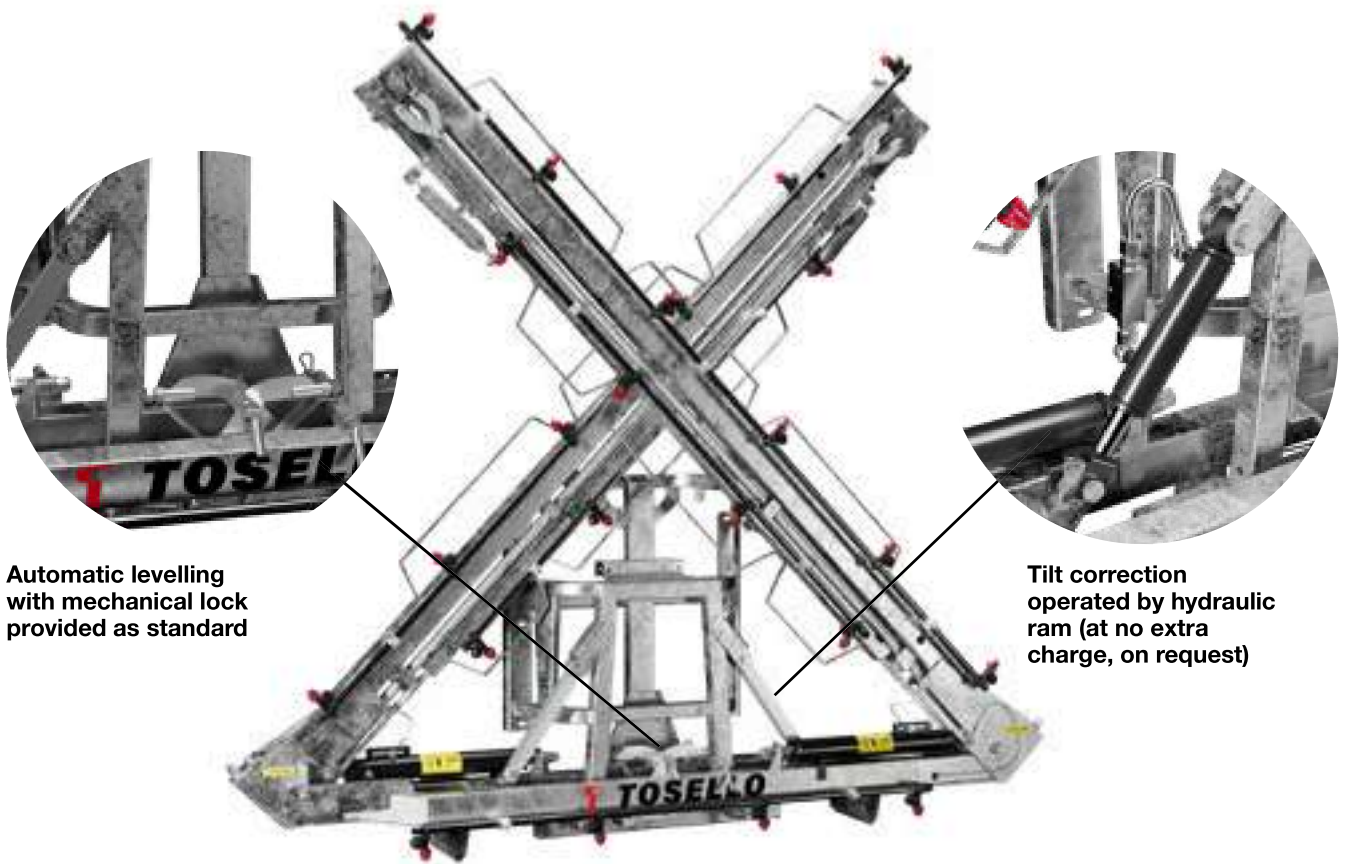

Automatic levelling with mechanical lock provided as standard

Tilt correction operated by hydraulic ram (at no extra charge, on request)

P2 is the professional boom series. Tried and tested over the years, they are part of our signature product range. They stand out for their impressive resistance to mechanical stress and for the functional mechanically locking auto levelling system. It works like a 4-cylinder weed spray boom, but has just two cylinders, which activate a tie rod allowing the outermost section to open and close: there is a clear benefit to this system in terms of convenience, as only two hydraulic couplers are required. It can be fitted with a mechanically locking self-levelling system built into the boom, or boom tilt correction operated by a hydraulic ram.

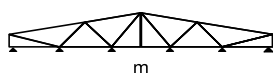

10	1950 x 500 x 2450	200
12	2150 x 500 x 2450	215
14	2800 x 500 x 2450	235
15	2950 x 500 x 2450	240



# Lifts and self-levelling systems

Manual and hydraulic lifts for use in conjunction with our weed spray booms, allowing you to work even with taller crops. You can choose from the simplest winch lift through to the higher performance lift featuring airbag suspension, which is designed to dampen stress put on the boom.

Tried and tested over the years, they stand out for their slim depth, which allows the centre of gravity to be kept further towards the tractor, ensuring greater operator safety.

Self-levellers can be used in conjunction with both the manual-fold weed spray booms and with the L2 hydraulic range. They help keep the boom in a neutral position, even when dealing with uneven ground, and optimize product application over the crop. They can come with a hydraulic ram for use on hilly terrain.



Winch lift for manual-fold and L2 booms



Winch lift for L2 boom



Winch lift for P2 boom



**H1000 hydraulic lift for L2 booms**



**H1200 hydraulic lift for P2 booms**



**H1200 hydraulic lift with leaf spring suspension for P2 booms**



**H1000 hydraulic lift with airbag suspension**



**Self-leveller with hydraulic ram for manual-fold and L2 booms**



**Mechanical self-leveller for manual-fold and L2 booms**

