

  
MADE IN ITALY



**RU**



# U M

HIGH PRECISION  
CNC UNIVERSAL  
GRINDING MACHINES

RETTIFICATRICI UNIVERSALI CNC PER  
COMPONENTI AD ALTA PRECISIONE





# LOOKING FOR THE $\mu\text{m}$ ALLA RICERCA DEL $\mu\text{m}$

AZ RU universal grinding machines are high performance machines designed for customers who have to work with high precision tolerances. Constructive features are projected to ensure maximum machine stability during all the process phases. Thanks to a wide combination of wheelhead spindles, different types of machining can be integrated in a single clamping: external, internal, shoulder, face, taper grinding, complex profiles and threads. The grinding process is constantly monitored thanks to high-level and last-generation measurement and controls systems. The RU machines range meets the requests of a wide range of industries: aerospace, railways, automotive, energy, precision mechanical components.

La gamma di rettificatrici RU sono macchine ad alte prestazioni progettate per una clientela che lavora con tolleranze di forma e posizione nell'intervallo del micron. Le qualità costruttive sono state progettate per garantire la massima stabilità della macchina durante tutte le fasi di processo. Grazie all'ampia combinazione di mandrini per la testa portamola si possono integrare diversi tipi di lavorazione in un unico serraggio: rettifica esterna, interna, spallamenti, rettifica di profili conici, profili complessi e filettature. Il processo di rettifica è costantemente monitorato grazie a sistemi di misurazione e controllo di alto livello e di ultima generazione. Questa gamma di macchine soddisfa le esigenze di un'ampia gamma di settori quali l'aerospaziale, locomotive, automotive, energetico, componentistica meccanica di precisione.

## MACHINE MACCHINA

Depending on customers production needs, the RU machine can have two standard constructive configurations:

- table movement along the Z axis and wheelhead along the X axis
- fixed table and wheelhead movement along the X and Z axes.

The axes move on linear guides by high precision ball screw or linear motors. The workpiece is clamped by headstock and tailstock both easily positioned along

A seconda delle esigenze produttive della clientela la macchina RU può avere due configurazioni standard a livello costruttivo:

- movimentazione della tavola lungo l'asse Z e della testa portamola lungo l'asse X
- tavola fissa e movimentazione della testa portamola lungo gli assi X e Z.

Gli spostamenti lungo gli assi avvengono su guide lineari tramite viti a ricircolo di sfere ad alta precisione o motori lineari. Il pezzo da lavorare è bloccato tra

**>> OLTRE LA RETTIFICA  
>> BEYOND GRINDING**



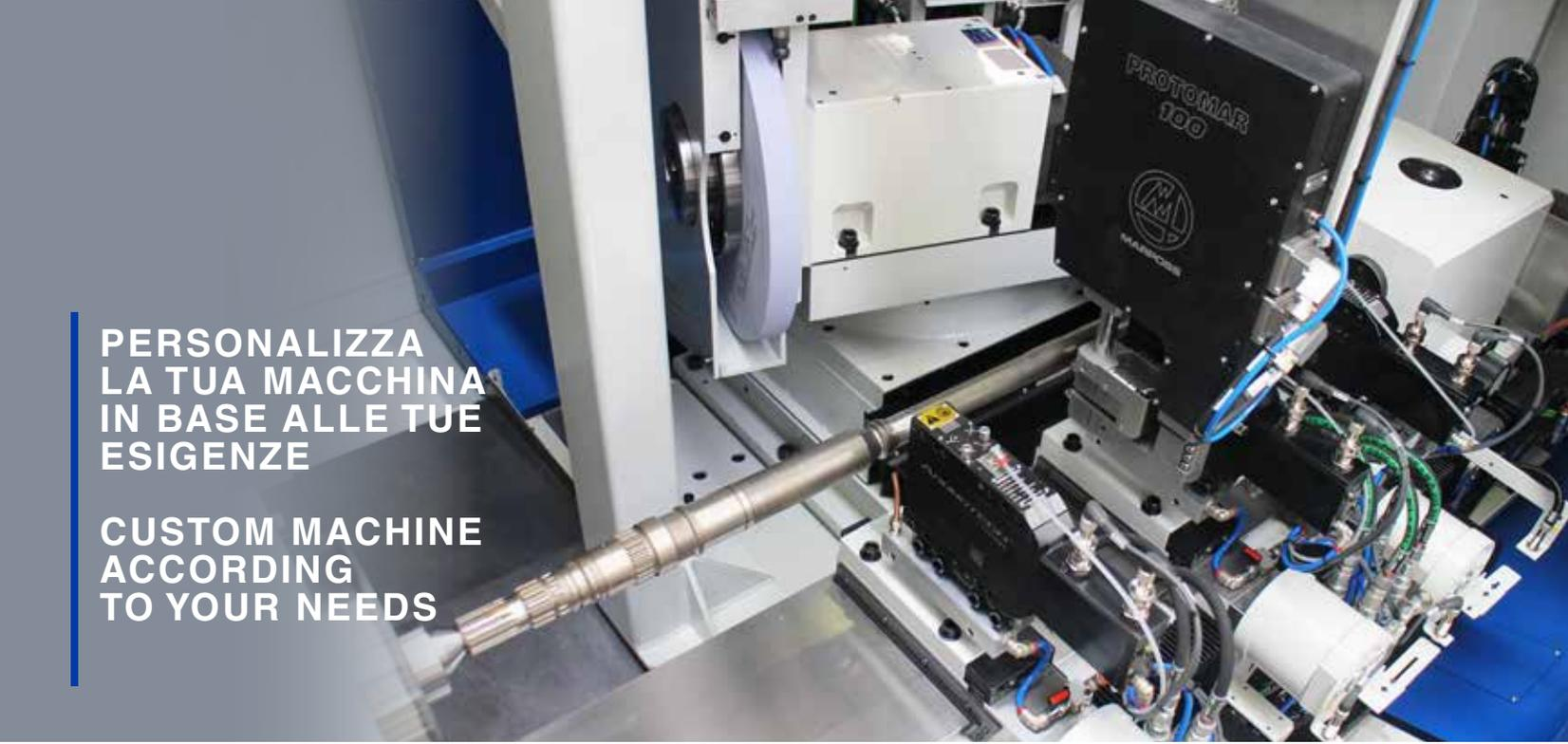

**PERSONALIZZA  
LA TUA MACCHINA  
IN BASE ALLE TUE  
ESIGENZE**

**CUSTOM MACHINE  
ACCORDING  
TO YOUR NEEDS**

the table. Base is specifically designed to obtain the best result between structural deformations and vibration dumping. The table and the headstock can swivel CNC or manually controlled.

la fantina e la contropunta entrambe posizionabili facilmente lungo la tavola. Il basamento è studiato appositamente per ottenere il miglior risultato tra deformazioni strutturali e smorzamento delle vibrazioni. La tavola e la fantina possono ruotare automaticamente tramite CNC o manualmente.



# HEADSTOCK & TAILSTOCK FANTINA E CONTROPUNTA

The headstock is designed to use different clamping systems in accordance with the specific workpiece. The headstock can swivel manually or automatically. Headstock and tailstock use morse cone or asa centering system. The tailstock moves on air cushion and is equipped with conicity (taper)

La fantina è progettata in modo da poter montare diversi tipi di serraggio del pezzo, le soluzioni possono essere personalizzate a seconda del pezzo da lavorare. La fantina può ruotare manualmente o automaticamente. Fantina e contropunta hanno la possibilità di centraggio del pezzo con cono Morse

**>> TESTE STUDIATE PER  
DIFFERENTI DIAMETRI E  
PESI PEZZO**

**>> DESIGNED FOR  
DIFFERENT DIAMETERS  
AND WEIGHTS**

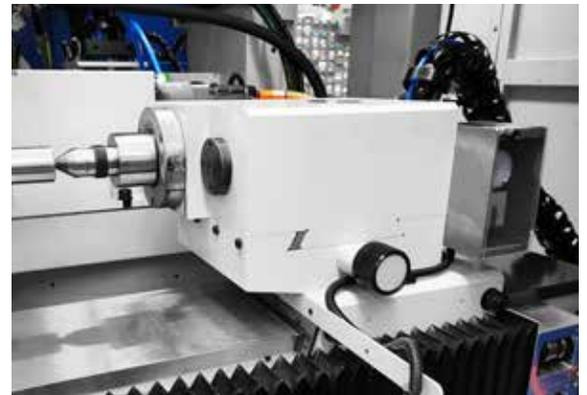
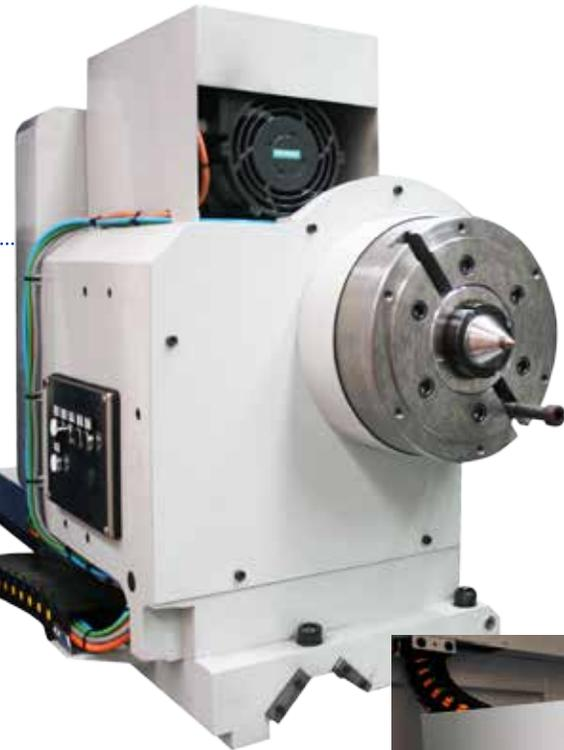

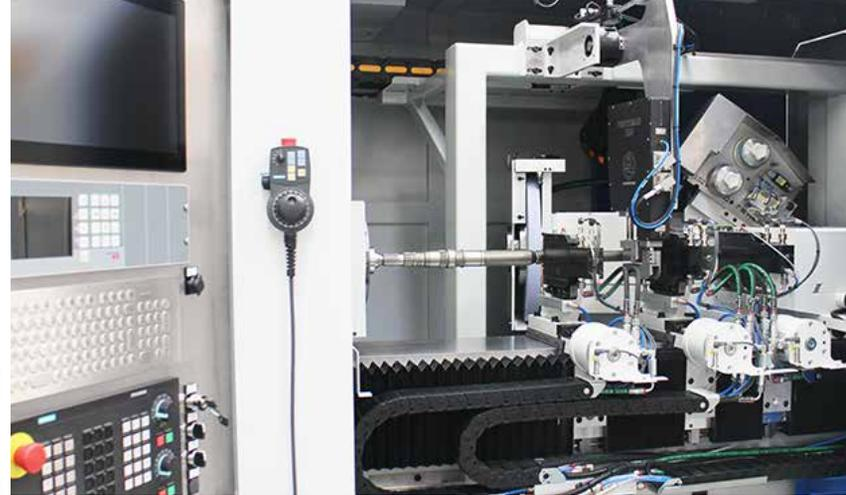

## DIFFERENTI SISTEMI DI SUPPORTO E SERRAGGIO IN BASE AL PEZZO DA LAVORARE

### DIFFERENT SUPPORTS & CLAMPING SYSTEMS ACCORDING TO CUSTOMER WORKPIECE



adjustment and continuous control of the force between centers with the possibility of footer pedal control.

The machine can be equipped with different workpiece supports that can be moved manually or automatically along the table:

- 2 points manual steady rest for external grinding
- 3 points automatic steady rests for external grinding
- 3 points steady rests for internal grinding
- Loading and unloading V support steady rests

o ASA. La contropunta si muove su cuscino d'aria ed è dotata di un sistema di recupero della conicità e controllo continuo della forza tra i centri con possibilità di comando tramite pedaliera.

La macchina può essere dotata di diversi sistemi di supporto del pezzo mobili manualmente o automaticamente lungo la tavola:

- Supporto manuale a 2 punti di contatto per rettifica esterna
- Supporto automatico a 3 punti di contatto per rettifica esterna
- Supporto a 3 punti di contatto per rettifica interna
- Supporto a V per carico e scarico del pezzo

## GRINDING WHEEL HEAD TESTA PORTAMOLA

Grinding wheel carriage moves along Z and X axes by ballscrew and linear guides. The grinding wheel head position is controlled by closed loop linear encoder. The grinding wheel turret can mount different types of spindles and grinding wheels depending on customer requests and can have the following configurations:

- fixed
- manually B-axis rotation  $\pm 20^\circ$
- automatically B-axis rotation  $\pm 30^\circ$  or  $\pm 360^\circ$

The grinding wheel can be equipped with automatic balancing system and vibration control. The grinding wheel dressing can be made by automatic fixed point dresser, combined fixed points dresser or roller diamond dresser mounted on the back of workheads. The turret can be equipped with fixed or removable internal grinding spindles, as well as a device for super-finishing.

### >> CONFIGURAZIONI TESTA PORTAMOLA MODULARI >> MODULAR WHEEL HEAD UNIT CONFIGURATION

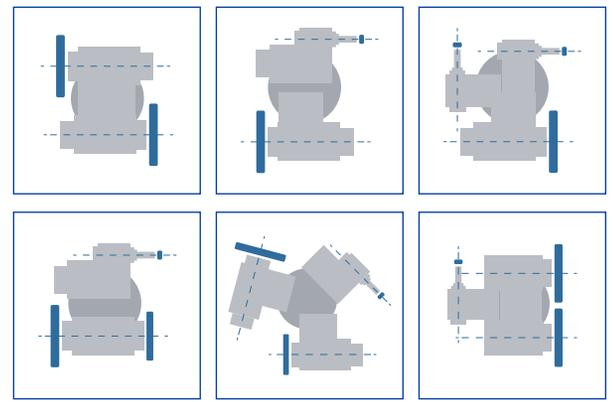

La testa portamola si muove lungo gli assi tramite guide lineari. La posizione della testa è controllata mediante encoder lineare a ciclo chiuso. La torretta portamola può montare differenti tipi di mandrini e mole a seconda delle esigenze di lavorazione e può avere le seguenti configurazioni:

- fissa
- rotante lungo l'asse B manualmente di  $\pm 20^\circ$
- rotante lungo l'asse B automaticamente di  $\pm 30^\circ$  o  $\pm 360^\circ$

Il sistema di rettifica è dotato di bilanciamento completamente automatico e controllo delle vibrazioni. La diamantatura della mola può essere eseguita tramite diamantatore a pettine su stazione fissa, diamantatore combinato a punti fissi o a disco montati sul retro delle teste portapezzo. La torretta può montare mandrini per la rettifica per interni fissi o smontabili, oltre che un dispositivo per la superfinitura.

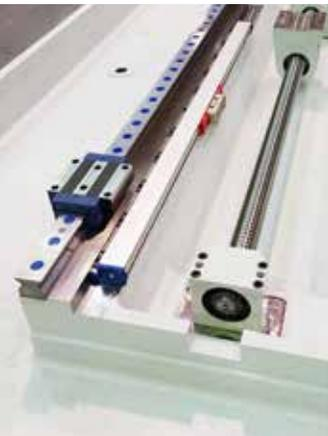



**SGROSSATURA, RETTIFICA  
E SUPERFINITURA DI  
DIAMETRI ESTERNI ED  
INTERNI IN UN UNICO  
SERRAGGIO PEZZO**

**ONE CLAMPING FOR  
MULTIPLE PROCESSES:  
EXTERNAL-INTERNAL  
ROUGHING-GRINDING AND  
SUPER-FINISHING**

- >> **DIAMANTATURA PER TUTTI I TIPI DI MOLE**
- >> **DIFFERENT WHEEL DRESSING SYSTEM**



# CONTROL & MEASURING SYSTEM SISTEMA DI CONTROLLO E MISURAZIONE

The machine is fully CNC controlled with customizable graphic interface and cycles.

The machine is equipped with  
**MODULAR MULTI-FUNCTION SYSTEM FOR GRINDING PROCESS CONTROL**

this system can be configured according to customer requests:

- grinding wheel/workpiece contact control
- grinding wheel/diamond contact control and tool usury recovery system
- crash control
- wheel balancing control with automatic balancing device
- workpiece and grinding wheel positioning control with touch probe

La macchina è completamente monitorata dal sistema di controllo CNC che può avere interfaccia grafica e cicli personalizzati.

La macchina è dotata di  
**SISTEMA MODULARE MULTIFUNZIONE PER IL CONTROLLO DEL PROCESSO DI RETTIFICA**

questo sistema può essere configurato secondo le esigenze del cliente per il:

- controllo del contatto della mola con il pezzo
- controllo del contatto della mola con il diamante con recupero dell'usura dell'utensile
- controllo di collisione
- controllo di bilanciatura della mola con bilanciatore automatico
- controllo posizionamento del pezzo e della mola con tastatore

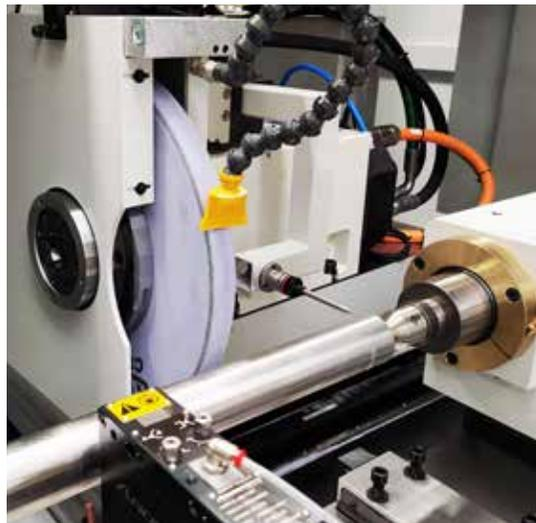

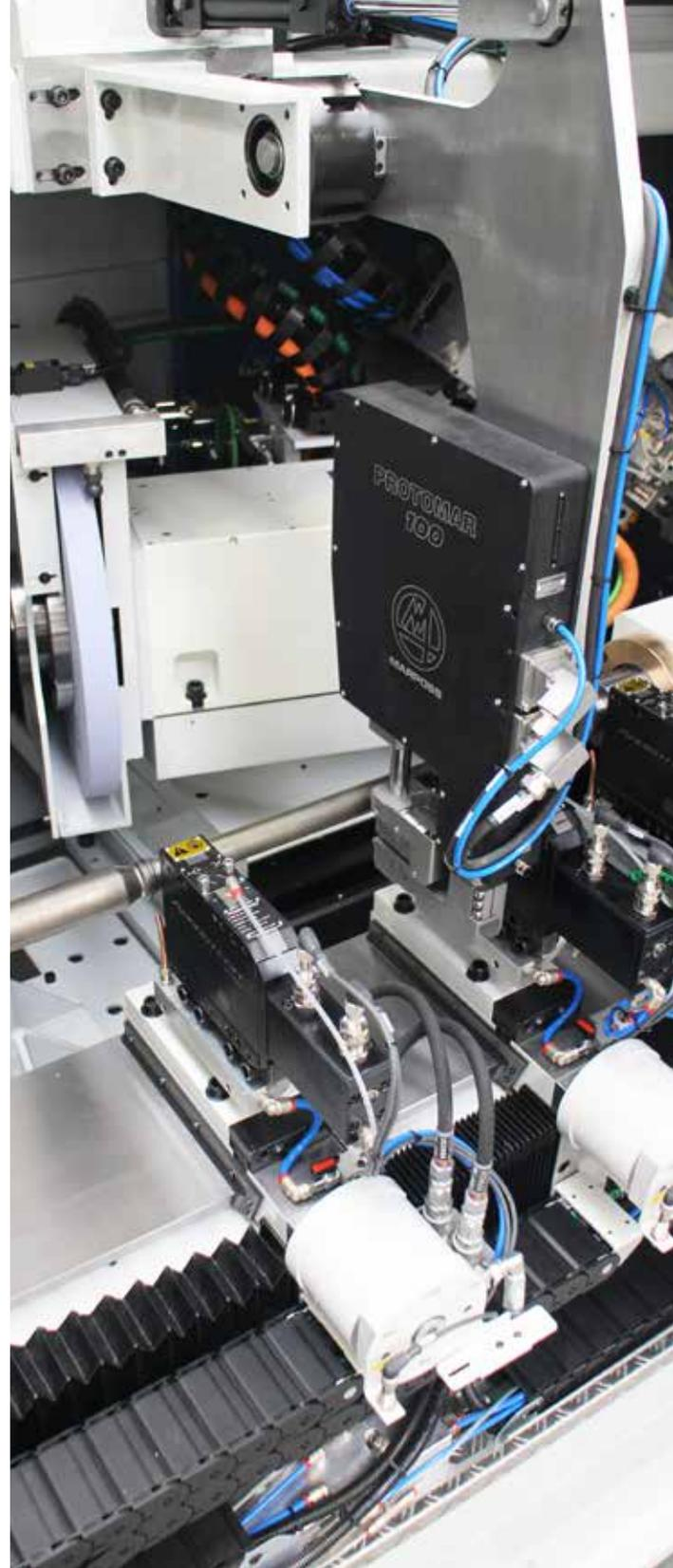
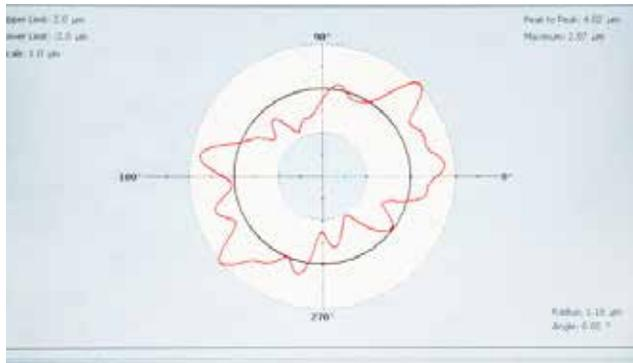

## UNIVERSAL GRINDING MACHINES



**MISURATORI  
IN-PROCESS  
ASSOLUTI O  
RELATIVI**

**ABSOLUTE OR  
RELATIVE  
IN-PROCESS  
MEASURERS**

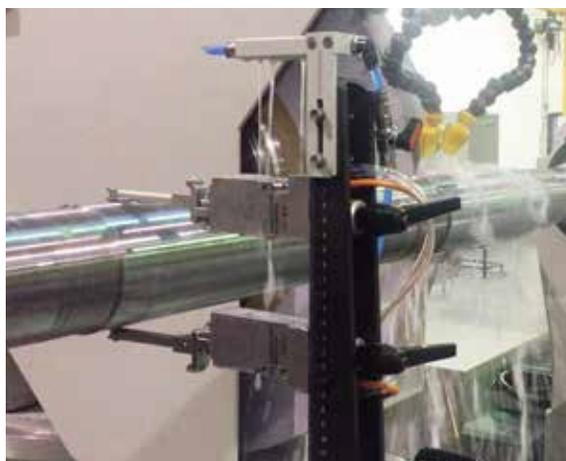

- in-process diameter control with 2 points measurement
- controllo in-process diametrale con sistema di misurazione in continuo a due punti
- digital in process journal size gauge with measuring fork manual engagement
- misuratore in-process digitale con forcella a movimentazione manuale
- automatic modular gauge heads for in-process dimensional control
- teste di misura automatiche per controllo dimensionale in-process
- in-process diameter measuring with fork
- misuratore diametrale in-process a forcella



# TECHNICAL SPECIFICATIONS\*

## SPECIFICHE TECNICHE\*

		RU1000	RU1600	RU2000	RU2500	RU3000	RU3500
Height centers Altezza centri	[mm]	225	275	300	300	400	400
Swing over table Swing	[mm]	400	500	550	550	700	700
Distance between centers Distanza tra i centri	[mm]	1000	1600	2000	2500	3000	3500
OD Grinding wheel diameter range Range di diametri per mola OD	[mm]	508	610	610	760	760	760
Width of grinding wheel Spessore della mola OD	[mm]	70	80	100	140	140	140
Maximum weight between centers Peso ammissibile fra i centri	[kg]	80	160	250	500	1500	1500
Grinding wheel spindle power Potenza mandrino testaportamola	[kW]	7	11	15	15	15	15
Headstock spindle power Potenza motore fantina	[kW]	2.3	2.3	2.3	2.3	3.6	3.6
Headstock speed range Range di velocità fantina	[rpm]	1000	750	750	750	500	500

*\*Indicative data, definitive technical specifications are released during project phase.*

*\*Questi dati sono indicativi, le specifiche tecniche definitive vengono rilasciate in fase di progettazione.*



PIECE AUTOMATIC LOADING-UNLOADING  
CARICO-SCARICO PEZZO AUTOMATIZZATO



**AZSmartservice**  
always close to you

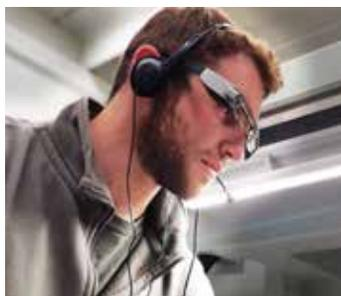

## OTHER MODELS

### ALTRI MODELLI



UNIVERSAL GRINDING MACHINE  
RETTIFICATRICI UNIVERSALI CONVENZIONALI



CNC UNIVERSAL GRINDING MACHINE  
RETTIFICATRICI UNIVERSALI CNC



HIGH PRECISION CNC UNIVERSAL GRINDING MACHINE  
RETTIFICATRICI UNIVERSALI CNC AD ALTA PRECISIONE



CNC HEAVY DUTY UNIVERSAL GRINDING MACHINE  
RETTIFICATRICI UNIVERSALI CNC PER PEZZI DI GRANDI DIMENSIONI





AZ spa  
viale dell'elettronica 20  
36016 Thiene (VI) Italy

T +390445575543  
F +390445575756  
E info@azspa.it

[www.azspa.it](http://www.azspa.it)



Marketing Dept. of AZ spa EN/IT - 20210917

AZ Copyright ©2021 No part of this document may be reproduced, copied, adapted, or transmitted in any form or by any means without express written permission from AZ spa. The information given is based on the technical levels of our machines at the time of this brochure going to print. We reserve the right to further develop our machines technically and make name, design, technical specifications, equipment etc. modifications.

AZ Copyright ©2021 È vietata la riproduzione, la copia o la trasmissione, anche parziale, di immagini, testi o contenuti senza autorizzazione scritta di AZ spa. Le informazioni contenute si riferiscono al livello tecnico delle nostre macchine nel momento che questa brochure è stata stampata. Ci riserviamo il diritto di modificare le macchine a livello tecnico apportando modifiche ai nomi, al design, alle specifiche tecniche, alla dotazione ecc.