

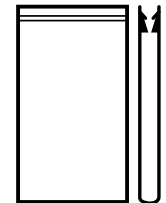

BAG MACHINE UNIVERSALE / MULTI PURPOSE

MP80-110

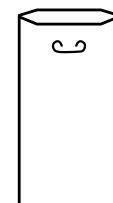
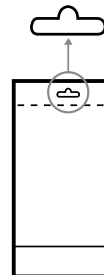
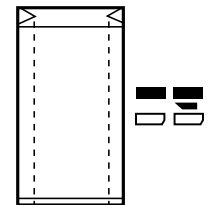
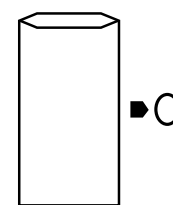

Preset recipes
for quick start



Intuitive touch-screen
interface



Remote assistance
Industry 4.0



Brushless Motors
allow high-performance



BAG MACHINE UNIVERSALE / MULTI PURPOSE

MP80-110

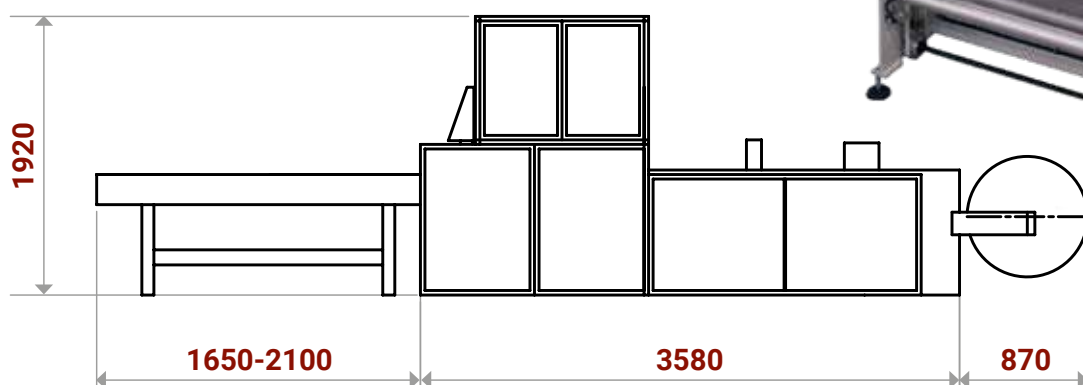
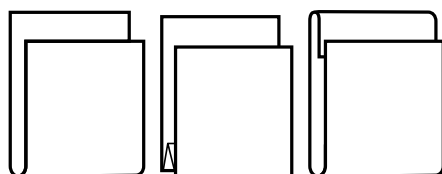
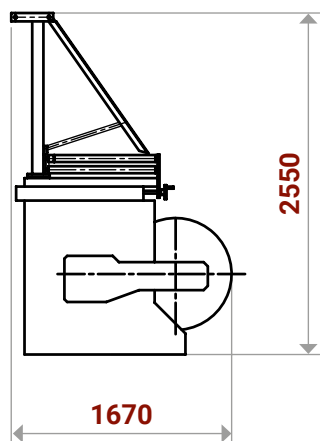

MAIN FEATURES

Seal width: 800 mm / 1100 mm

Min bag length: 55 mm

Max. bag length: 800 mm

Film thickness – wedge sealer:
Min. 2 x 0.010 mm; max. 2 x 0.070 mm

Film thickness – strip sealer:
Min. 2 x 0.015 mm; max. 4 x 0.120 mm

Cycles per minute: 250

Max. film speed: 100 mt/min

Power feed: 3P + N 400 V 50 Hz

Compressed air: 0.60 Mpa - 0.02 m³/ sec

Max. reel diameter: 800 mm

CARATTERISTICHE PRINCIPALI

Larghezza saldatura: 800 mm / 1100 mm

Lunghezza min. busta: 55 mm

Lunghezza max. busta: 800 mm

Spessore saldabile a cuneo:
Min. 2 x 0.010 mm; max. 2 x 0.070 mm

Spessore max. saldabile a piattina:
Min. 2 x 0.015 mm; max. 4 x 0.120 mm

Cicli al minuto: 250

Velocità max. film: 100 mt/min

Alimentazione: 3P + N 400 V 50 Hz

Aria compressa: 0.60 Mpa - 0.02 m³/ sec

Diametro massimo bobina: 800 mm