

— WARDROBES
Collection

ERBA

— Un'anteprima
del nostro concetto
di contenimento.
Tante soluzioni
e tante risposte
per ogni progetto.

EN *A preview of our storage concept. Many solutions and answers for each project.*

FR *Une avant-première de notre concept de rangement. Beaucoup de solutions et de réponses pour chaque projet.*

— Cover,
l'armadio versatile
con ante e fianchi
rivestiti in tessuto,
specchio, vetro laccato
o carta da parati.



EN Cover, the versatile wardrobe with doors and sides coated with fabric, mirror, lacquered glass or wallpaper.

FR Cover, l'armoire polyvalente avec portes et côtés revêtus en tissu, miroir, verre laqué ou papier peint.



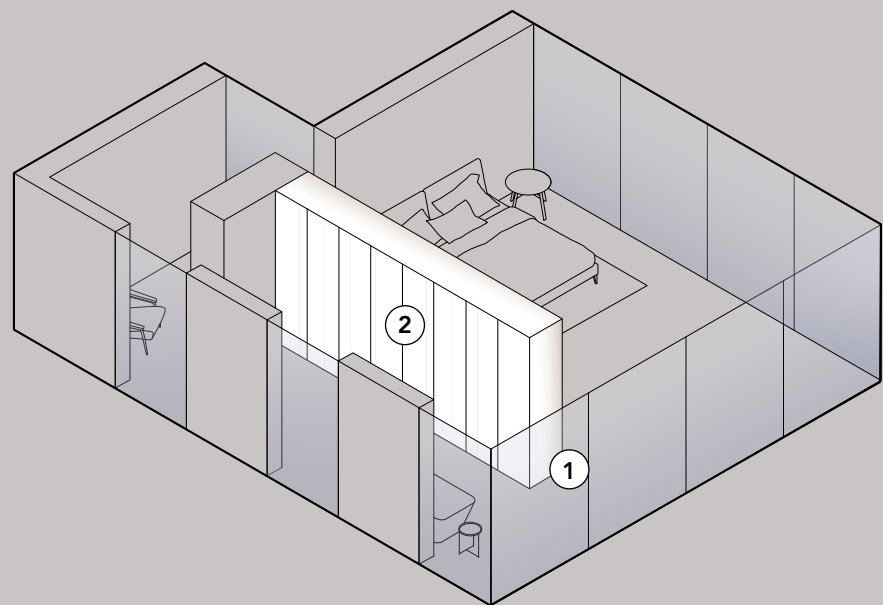

1

IT Il fianco esterno è realizzabile con le stesse finiture delle ante (tessuto, vetro laccato o specchio). Un dettaglio unico e distintivo della collezione Cover.

EN The external side can be realized with the same finish as the doors (fabric, lacquered glass or mirror). A unique and distinctive detail of the Cover collection.

FR Le côté extérieur est disponible dans les mêmes finitions que les portes (tissu, verre laqué ou miroir). Un détail unique et distinctif de la collection Cover.

2

IT Armadio che può essere utilizzato per dividere gli spazi essendo accessibile da entrambi i lati.

EN The wardrobe can be used to divide the spaces as its doors can be opened on both sides.

FR L'armoire peut être utilisée pour séparer une pièce puisque ses portes s'ouvrent sur les deux côtés.

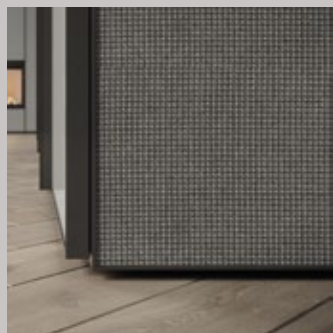



IT Ante in tessuto con profili
colore Piombo.
EN Fabric doors with edges in
Piombo finish.
FR Portes en tissu avec profiles
en finition Piombo.



IT Ante in vetro laccato con
profili colore bianco.
EN Lacquered glass doors
with edges in white finish.
FR Portes en verre laqué avec
profils en finition blanc.

— Cover / Lineauno

IT Cover e Lineauno sono compatibili tra loro. Si ampliano le possibilità compositive, creando nuove soluzioni coerenti sia per caratteristiche costruttive che per maniglia.

EN Cover and Lineauno are compatible with each other. More project possibilities thanks to the the same construction of the wardrobes and same handle.

FR Cover et Lineauno sont deux systèmes qui communiquent l'une avec l'autre. Plus de possibilités au niveau de projet grâce aux mêmes détails de construction et même poignée.

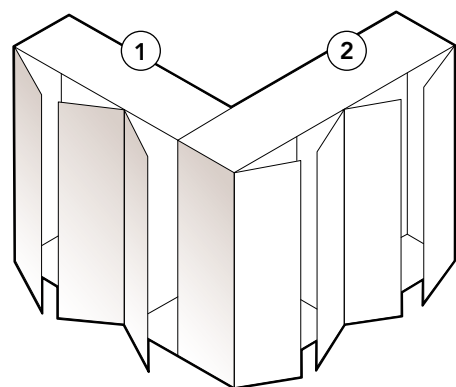

①

IT Armadio COVER con ante a specchio
EN Wardrobe COVER with mirror doors
FR Armoire COVER avec portes miroir

②

IT Armadio LINEAUNO con fianco esterno a specchio
EN Wardrobe LINEAUNO with mirror external side
FR Armoire LINEAUNO avec côté extérieur miroir



— Cover

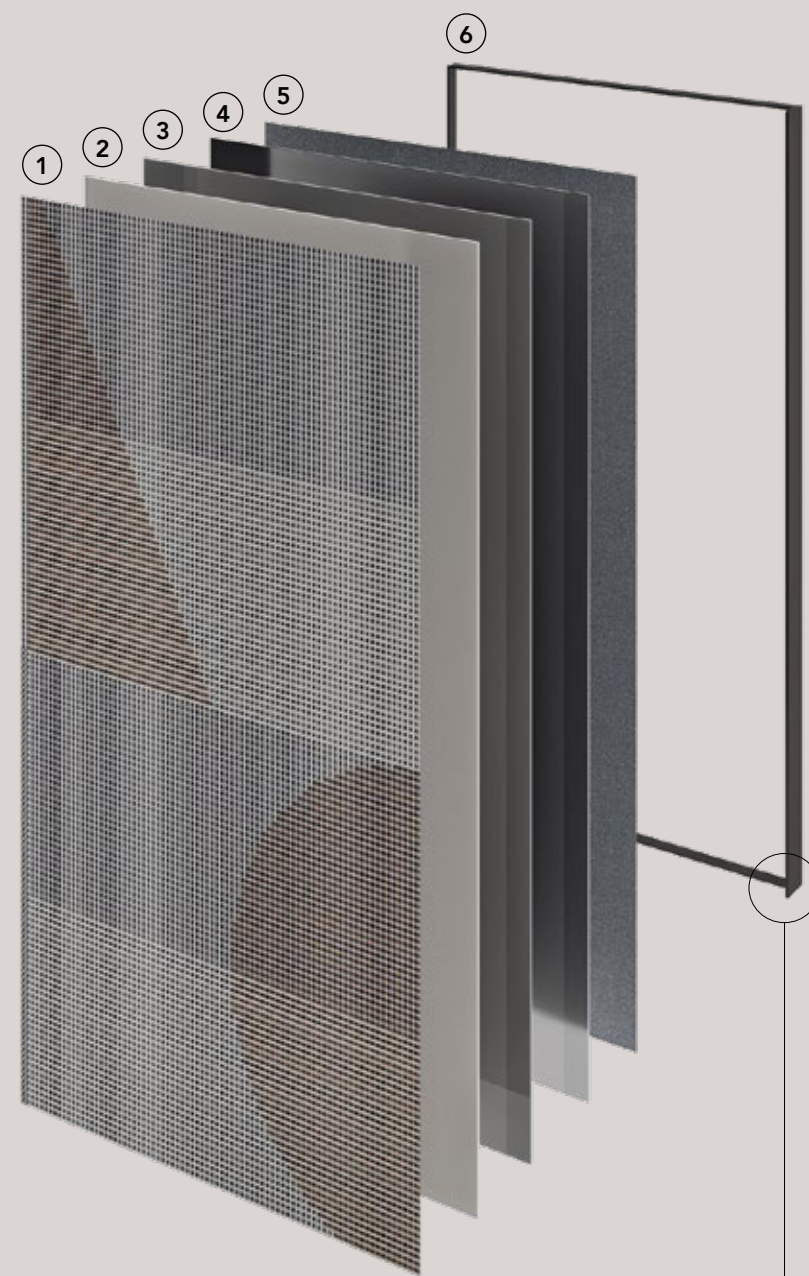

- ①
IT Carta da parati
EN Wallpaper
FR Papier peint
- ②
IT Vetro satinato laccato
EN Matt lacquered glass
FR Verre mat laqué
- ③
IT Vetro lucido laccato
EN Glossy lacquered glass
FR Verre brillant laqué
- ④
IT Specchio
EN Mirror
FR Miroir
- ⑤
IT Tessuto
EN Fabric
FR Tissu
- ⑥
IT Profili perimetrali in alluminio
EN Perimeter aluminium edges
FR Profils sur le périmètre en aluminium

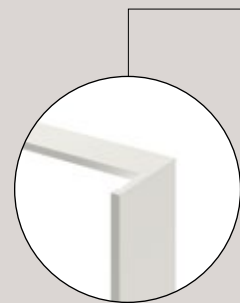

IT Profilo bianco
EN Edge in white finish
FR Profil blanc

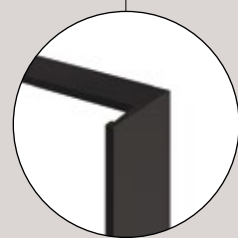

IT Profilo piombo
EN Edge in piombo finish
FR Profil piombo

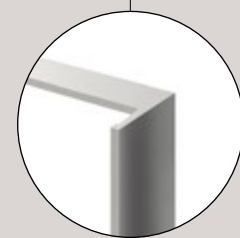

IT Profilo alluminio
EN Edge in aluminium finish
FR Profil aluminium



IT Anta e fianco in vetro laccato / **EN** Door and side coated with lacquered glass / **FR** Porte et côté en verre laqué



IT Anta e fianco a specchio / **EN** Door and side coated with mirror / **FR** Porte et côté miroir



IT Anta e fianco in tessuto / **EN** Door and side coated with fabric / **FR** Porte et côté en tissu



IT Anta rivestita con carta da parati / **EN** Door coated with wallpaper / **FR** Porte avec du papier peint

— Geo è un sistema
ad ante scorrevoli
disponibili in
nobilitato, specchio,
vetro laccato
o tessuto.
Una combinazione
di materiali per
progettare l'armadio
secondo le proprie
esigenze e gusti.

EN Geo is a collection with sliding doors available in melamine, mirror, lacquered glass or fabric. A combination of materials to design the wardrobe in accordance with one's needs and tastes.

FR Geo est une collection d'armoires avec portes coulissantes disponibles en mélamine, miroir, verre laqué ou tissu. Une combinaison de matériaux pour créer l'armoire selon ses besoins et goûts.







— Geo / Lineauno

IT Gli armadi delle collezioni Geo (ante scorrevoli) e Lineauno (ante battenti) possono essere affiancati grazie alla gamma comune di finiture e alla possibilità di utilizzo della stessa maniglia.

EN Wardrobes of Geo collection (sliding doors) and Lineauno collection (hinged doors) can be combined thanks to the same range of finishes and the possibility to install the same handle.

FR Les armoires des collections Geo (portes coulissantes) et Lineauno (portes battantes) peuvent vivre dans la même pièce grâce à la gamme commune de finitions et à la possibilité d'installer la même poignée.

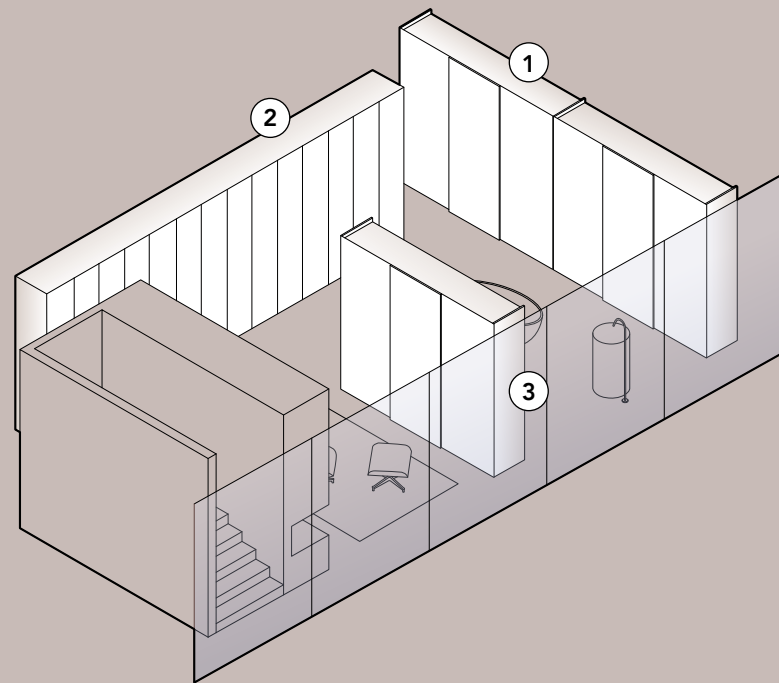

1

IT Geo: ante in nobilitato.
EN Geo: melamine doors.
FR Geo: portes en mélamine.

2

IT Lineauno: ante in nobilitato.
EN Lineauno: melamine doors.
FR Lineauno: portes en mélamine.

3

IT Geo: ante in vetro laccato.
EN Geo: lacquered glass doors.
FR Geo: portes en verre laqué.

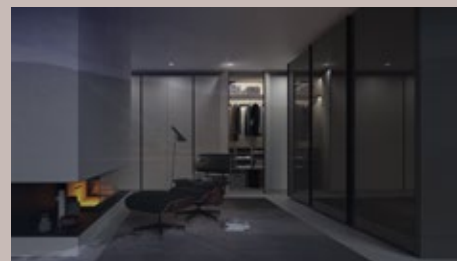

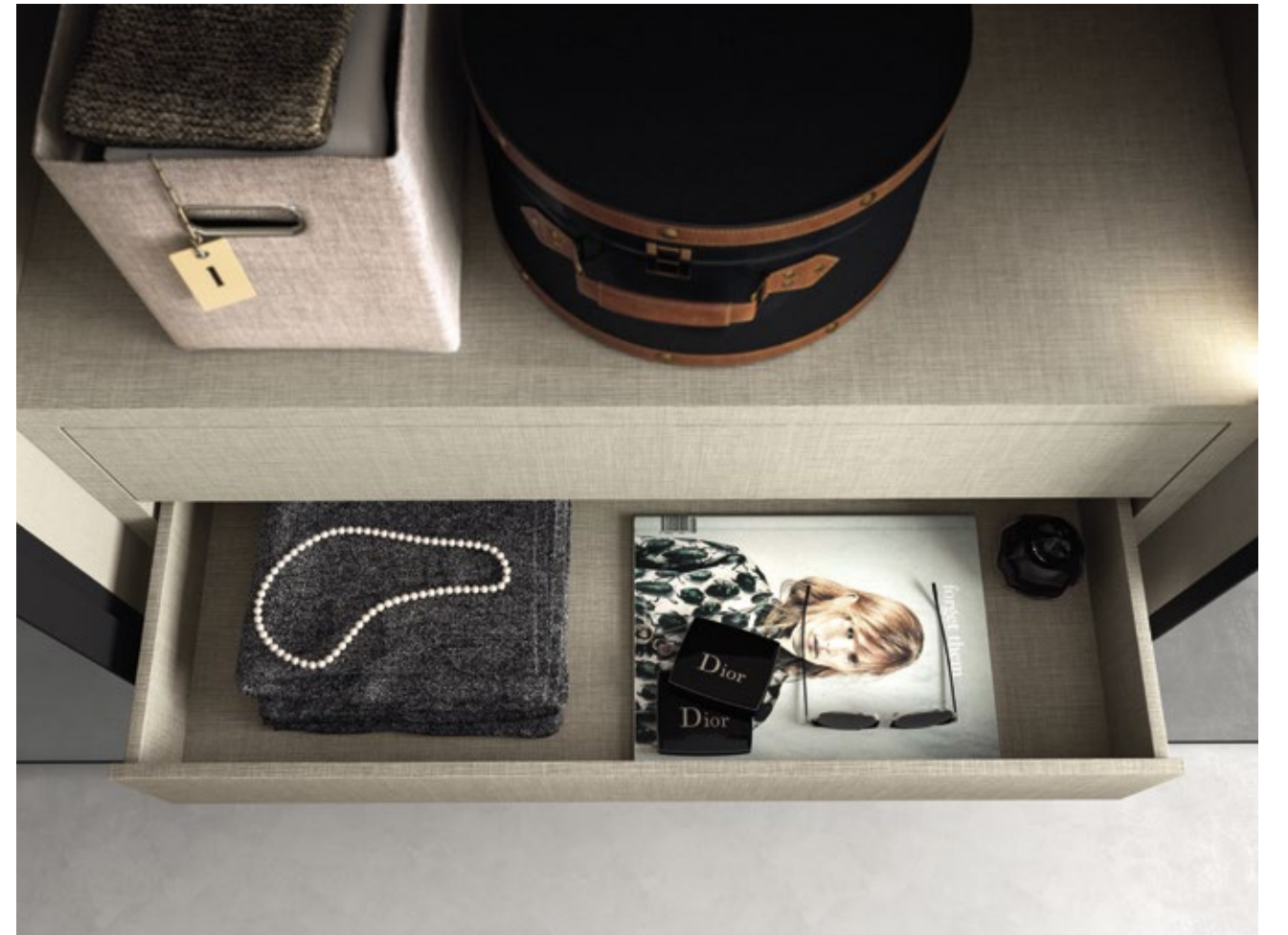



IT Ante scorrevoli in vetro laccato con profili in colore Piombo.
EN Lacquered glass sliding doors with edges in Piombo finish.
FR Portes coulissantes en verre laqué avec profils en finition Piombo.



- ①
IT Vetro satinato laccato
EN Matt lacquered glass
FR Verre mat laqué
- ②
IT Vetro lucido laccato
EN Glossy lacquered glass
FR Verre brillant laqué
- ③
IT Specchio
EN Mirror
FR Miroir
- ④
IT Tessuto
EN Fabric
FR Tissu
- ⑤
IT Profili perimetrali in alluminio
EN Perimeter aluminium edges
FR Profils sur le périmètre en aluminium
- ⑥
IT Nobilitato
EN Melamine
FR Mèlamine

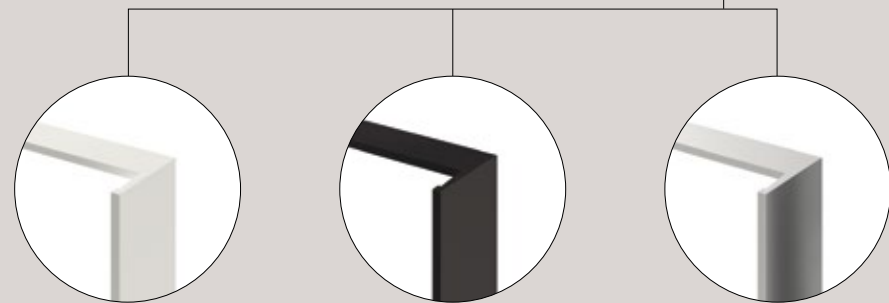

IT Profilo bianco
EN Edge in white finish
FR Profil blanc

IT Profilo piombo
EN Edge in piombo finish
FR Profil piombo

IT Profilo alluminio
EN Edge in aluminium finish
FR Profil aluminium



IT Profilo perimetrale
EN Perimeter edge
FR Profil sur le périmètre

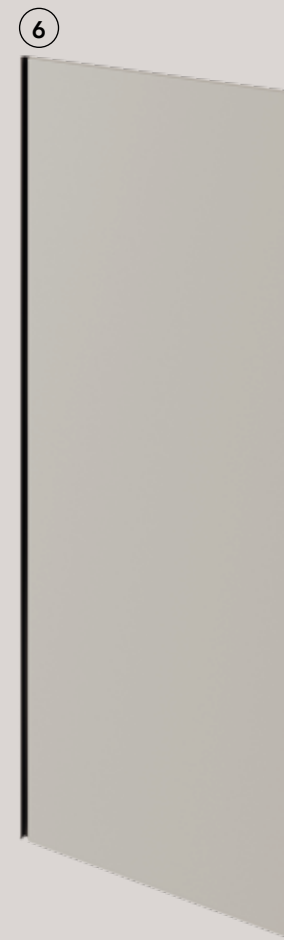

IT Maniglia M10
EN M10 handle
FR Poignée M10

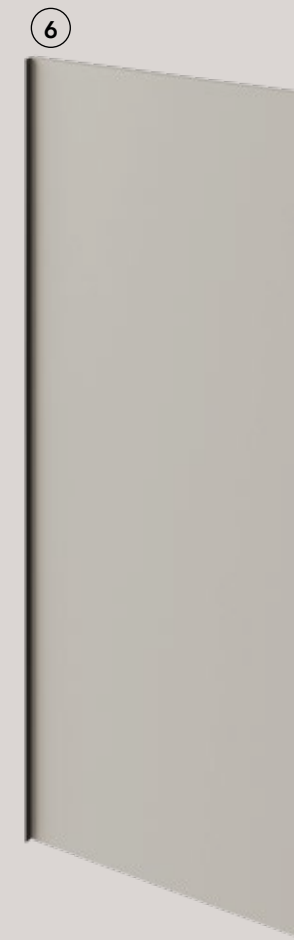

IT Maniglia M8
EN M8 handle
FR Poignée M8



IT Ante in nobilitato con maniglia
in rovere sbiancato.
EN Melamine doors with whitened
oak handle.
FR Portes en mélamine avec
poignée en chêne blanchi.



IT Ante in nobilitato con maniglia M10 che si estende su tutta l'altezza dell'anta. Maniglia laccata colore anta.
EN Melamine doors with M10 handle which extends along the door. Handle in lacquered finish as the door.
FR Portes en mélamine avec poignée M10 sur toute la hauteur. Poignée laquée, même finition que la porte.

— maniglie Lineauno

EN Lineauno handles / **FR** poignées Lineauno



IT Maniglia M14 in metallo. Disponibile in finitura argento, nero, bianco, piombo. / **EN** M14 metal handle. Available in silver, black, white and piombo finishes. / **FR** Poignée M14 en métal. Finitions disponibles: argent, noir, blanc, piombo.



IT Maniglia M4 in metallo. Disponibile in finitura argento (satinato o lucido), bianco, piombo e laccato. / **EN** M4 metal handle. Available in silver (matt or glossy), white, piombo and lacquered finishes. / **FR** Poignée M4 en métal. Finitions disponibles: argent (satin ou brillant), blanc, piombo et laque.



IT Maniglia M11 in rovere. Disponibile in finitura rovere e laccato. / **EN** M11 oak handle. Available in oak and lacquered finishes. / **FR** Poignée M11 en chêne. Finitions disponibles: chêne et laque.



IT Maniglia M12 in rovere. Disponibile in finitura rovere e laccato. / **EN** M12 oak handle. Available in oak and lacquered finishes. / **FR** Poignée M12 en chêne. Finitions disponibles: chêne et laque.



IT Maniglia M13 in rovere. Disponibile in finitura rovere e laccato. / **EN** M13 oak handle. Available in oak and lacquered finishes. / **FR** Poignée M13 en chêne. Finitions disponibles: chêne et laque.



IT Maniglia M15 in metallo. Disponibile in finitura argento, nero, bianco, piombo. / **EN** M15 metal handle. Available in silver, black, white and piombo finishes. / **FR** Poignée M15 en métal. Finitions disponibles: argent, noir, blanc, piombo.



IT Maniglia M15 in alluminio. Disponibile con fondo in tutte le finiture nostra gamma. / **EN** M15 aluminium handle. Bottom available in all our finishes. / **FR** Poignée M15 en aluminium. Fond poignée disponible en toutes les finitions de notre gamme.



IT Maniglia M8 in alluminio. Disponibile in finitura argento, bianco, piombo e laccato. / **EN** M8 aluminium handle. Available in silver, white, piombo and lacquered finishes. / **FR** Poignée M8 en aluminium. Finitions disponibles: argent, blanc, piombo et laque.



IT Maniglia M10 in alluminio. Disponibile in finitura argento, bianco, piombo e laccato. / **EN** M10 aluminium handle. Available in silver, white, piombo and lacquered finishes. / **FR** Poignée M10 en aluminium. Finitions disponibles: argent, blanc, piombo et laque.



IT Maniglia M16 in alluminio. Disponibile in finitura argento, bianco, piombo e nero. / **EN** M16 aluminium handle. Available in silver, black, white and piombo. / **FR** Poignée M16 en aluminium. Finitions disponibles: argent, noir, blanc, piombo.

— Luxe, l'armadio a vista.
L'anta color piombo
può essere personalizzata
con tre varianti vetro:
trasparente, fumé,
stopsol.



EN Luxe, the wardrobe like a showcase. The door, with frame in piombo finish, can be customised with three different glass: transparent, smoked or stopsol.

FR Luxe, l'armoire vitrine. La porte avec structure en piombo peut être personnalisée avec trois variantes de verre: transparent, fumé, réfléchant.





IT Struttura in nobilitato olmo abbinata ad ante con vetro trasparente.
EN Structure in melamine olmo with transparent glass doors.
FR Structure en mélamine olmo avec portes en verre transparent.



IT L'integrazione dell'anta LUXE con gli armadi della gamma LINEAUNO amplia notevolmente le possibilità progettuali. Armadio LUXE con struttura in nobilitato rovere rift ed ante con vetro trasparente. Armadio LINEAUNO con anta in nobilitato, maniglia M16.

EN The integration of Luxe and Lineauno collections increases considerably the design possibilities. Wardrobe LUXE with structure in rovere rift and transparent glass doors. Wardrobe LINEAUNO with melamine doors and M16 handle.

FR La combinaison de la porte Luxe avec les armoires de la collection Lineauno augmente considérablement les possibilités de projet. Armoire LUXE avec structure en mélamine rovere rift et portes en verre transparent. Armoire LINEAUNO avec portes en mélamine et poignée M16.

— Easy, semplice
ed essenziale,
non rinuncia a nessuno
standard qualitativo.





IT Esterno in nobilitato bianco ed interno in nobilitato canapa sono le finiture dell'armadio EASY.
EN External in melamine white and interior in melamine canapa. These are the selected finishes for EASY.
FR Extérieur en mélamine blanc et intérieur en mélamine canapa sont les finitions de l'armoire EASY.

— Cabina armadio autoportante caratterizzata da un'ampia gamma di accessori: cassettiere, moduli con ripiani, portascarpe, trave in alluminio che permette di appendere e di illuminare.

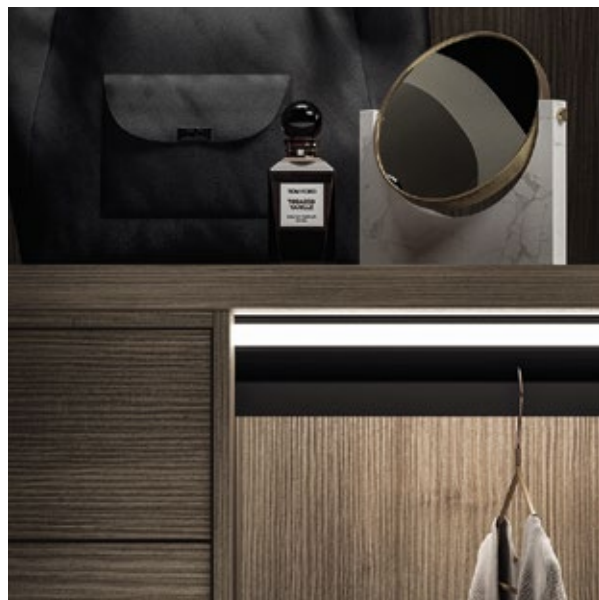

EN Self-supporting walk-in closet with a large range of accessories: drawer and shelves units, shoestand shelves, aluminium rail that allows to hang and light up.

FR Dressing autoporteur avec une large gamme d'accessoires: module à tiroirs ou étagères, porte-chaussures, barre en aluminium utilisée comme penderie ou système d'éclairage.





IT TUBE in nobilitato olmo e travi in finitura piombo.
EN TUBE in melamine olmo and rail in piombo finish.
FR TUBE en mélamine olmo et barres en finition piombo.

— esempi di contenitori con attrezzatura interna

EN examples of units with internal accessories / FR exemples de modules avec accessoires intérieurs



IT Ripiano con tubo appendiabiti / EN Shelf with hanger rod / FR Étagère avec tringle

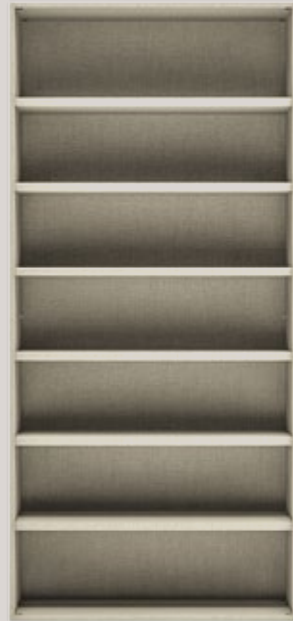

IT Ripiani / EN Shelves / FR Étagères



IT Ripiano con tubo appendiabiti e cassettera / EN Shelf with hanger rod and drawer unit / FR Étagère avec tringle et bloc tiroirs



IT Tubo appendiabiti _ Portacamicie _ Cassettera / EN Hanger rod _ Grid with shirt holder _ Drawer unit / FR Tringle _ Module porte-chemises _ Bloc tiroirs



IT Tubo appendiabiti _ Cassettera / EN Hanger rod _ Drawer unit / FR Tringle _ Bloc tiroirs



IT Ripiano con tubo appendiabiti _ Modulo con cassetto e portapantaloni estraibile / EN Shelf with hanger rod _ Unit with drawer and pull-out trousers rack / FR Étagère avec tringle _ Module avec tiroir et porte-pantalons extractible



IT Ripiani_Ripiani portascarpe / EN Shelves _ Shoestand shelves / FR Étagères _ Étagères porte-chaussures



IT Ripiani in vetro con telaio color piombo e ripiani con profilo color piombo / EN Glass shelves with frame in piombo finish and shelves with profile in piombo finish / FR Étagères en verre avec cadre en finition piombo et étagères avec profil en finition piombo

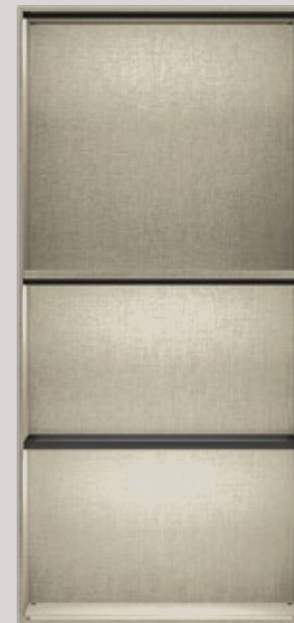

IT Modulo con LED orizzontali / EN Unit with horizontal LED / FR Module avec LED horizontaux

IT Su base superiore / EN On the top / FR Sur top

IT Su ripiano / EN On the shelf / FR Sur étagère

IT Su ripiano vetro / EN On the glass shelf / FR Sur étagère en verre



IT Su fianco / EN On the side / FR Sur côté

IT Modulo con LED verticali / EN Unit with vertical LED / FR Module avec LED verticales

— attrezzatura interna

EN internal accessories / FR accessoires intérieurs

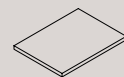

IT Ripiani / EN Shelves / FR Étagères

I. / w. 42,8 / 57,8 / 87,8 / 117,8
p. / d. 49 / 41
sp. / th. / ép. 2,2 / 3,5

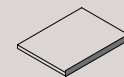

IT Ripiani con profilo in alluminio color piombo
EN Shelves with aluminium edge in piombo finish
FR Étagères avec profil en aluminium finition piombo

I. / w. 42,8 / 57,8 / 87,8 / 117,8
p. / d. 49 / 41
sp. / th. / ép. 3,5

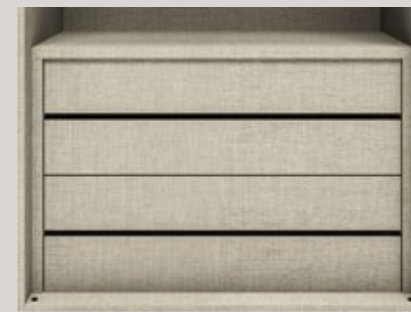

IT Cassettiera quattro cassetti / EN Unit with four drawers / FR Bloc quatre tiroirs

I. / w. 57,8 / 87,8 / 117,8
p. / d. 49 / 35
h. 75,5

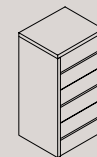

IT Cassettiera sei cassetti / EN Unit with six drawers / FR Bloc six tiroirs

I. / w. 57,8 / 87,8 / 117,8
p. / d. 49 / 35
h. 111,5

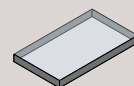
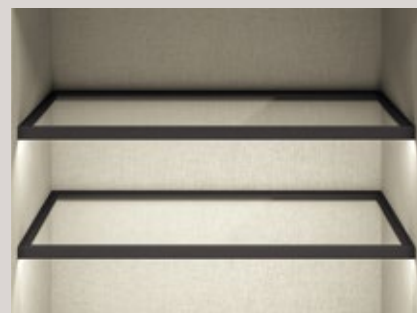

IT Ripiani in vetro trasparente con telaio in alluminio color piombo / EN Transparent glass shelves with aluminium frame in piombo finish / FR Étagères en verre transparent avec cadre en aluminium finition piombo

I. / w. 42,8 / 87,8
p. / d. 49
sp. / th. / ép. 3,5

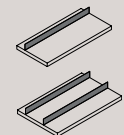
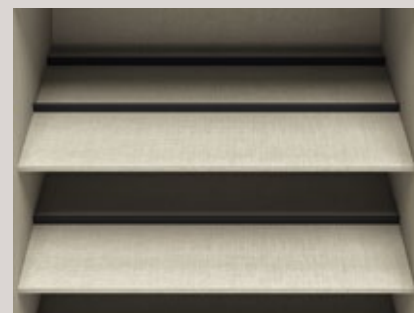

IT Ripiani portascarpe con profili color piombo
EN Shoestand shelves with bars in piombo finish
FR Étagères porte-chaussures avec profils en finition piombo

I. / w. 42,8 / 57,8 / 87,8 / 117,8
p. / d. 55 / 42
sp. / th. / ép. 2,2

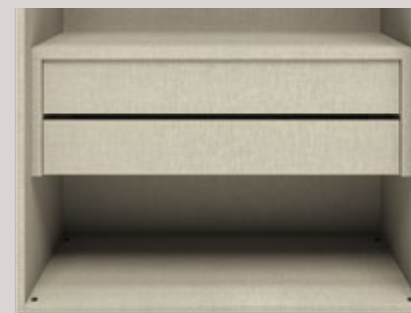

IT Cassettiera due cassetti / EN Unit with two drawers / FR Bloc deux tiroirs

I. / w. 57,8 / 87,8 / 117,8
p. / d. 49 / 35
h. 39,5

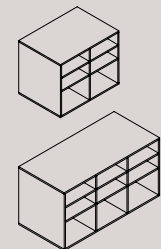

IT Moduli portacamicie / EN Grid with shirt holder / FR Modules porte-chemises

I. / w. 87,8 / 117,8
p. / d. 45,5
h. 50,5



IT Tubo appendiabiti / EN Hanger rod / FR Tringle

I. / w. 42,8 / 57,8 / 87,8 / 117,8

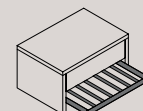

IT Modulo con cassetto e portapantaloni estraibile
EN Unit with drawer and pull-out trousers rack
FR Module avec tiroir et porte-pantalons extractible

I. / w. 87,8
p. / d. 49
h. 39,5

— illuminazione interna

EN internal lights / FR éclairage intérieur



IT Modulo con LED verticale / EN Unit with vertical LED
FR Module avec LED vertical



IT Modulo con LED orizzontali su base superiore, ripiano e ripiano vetro
EN Unit with horizontal LED on the top, on the shelf and on the glass shelf
FR Module avec LED horizontaux sur top, étagère et étagère en verre

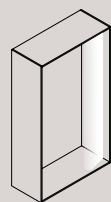

IT Ripiano in vetro con LED
EN Glass shelf with LED
FR Etagère en verre avec LED

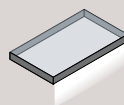

IT Base superiore e ripiano con LED
EN Top and shelf with LED
FR Top et étagère avec LED

— Erba

IT L'azienda / EN The company / FR L'entreprise

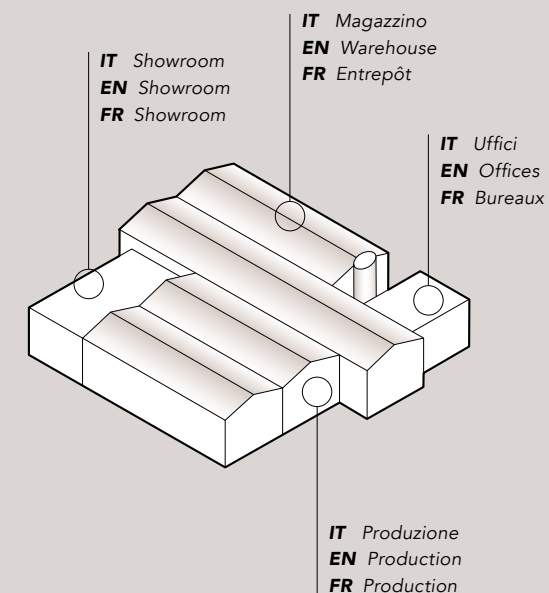

— Da più di **50 anni** Erba è presente nel mercato dell'arredo.

L'unità produttiva e lo showroom sorgono nel **Distretto della Brianza**, territorio noto per l'eccellenza produttiva nel settore arredo di fascia medio-alta e per le forti competenze tecniche e potenziale creativo.

Il prodotto Erba viene concepito come un capo sartoriale. Nasce da qui il desiderio di "vestirlo" al meglio. "Sartorialità" significa anche "a misura", uno dei servizi che contraddistingue l'azienda.

EN For more than **50 years**, Erba has been present in the furnishing industry. The production centre and showroom are located in **Brianza**, an area famous for high-end excellent furnishing production, expert workmanship, technical skills, and great creativity. The product Erba is like a tailored suit. This gives rise to the desire to better "dress" the product. "Tailoring" also means "made-to-measure", one of the services that distinguishes the company.

FR Depuis plus de **50 ans** Erba est présente sur le marché de l'ameublement. La production et le showroom se trouvent dans la région de la **Brianza**, territoire connu pour ses excellents produits de gamme moyenne supérieure dans le secteur de l'ameublement et pour les grandes compétences techniques et son potentiel de créativité. Le produit Erba est le résultat du travail d'un atelier de couture. C'est ici que naît le désir d'"habiller" le produit au mieux. "Haute couture" signifie également "sur mesure", un des services qui caractérise l'entreprise.

ERBA

Via Don Guanella, 28 C.P. 119
22066 Mariano Comense (Como)
T. +39 031 746 663 | F. +39 031 750 624
erba@erbamobili.it | www.erbamobili.it

Art direction / Styling / Graphic / Digital image Genny Canton Studio

Color Correction Studio Emmequadro

Printed by Sincromia

December 2018