

MODELLO GHIGLIOTTINA

Vertical sliding door
Porte mod. "A Guillotine".

Porta mod. "Ghigliottina"

La porta scorrevole verticale in versione manuale o automatica è adatta ad ogni tipo di cella per temperature positive o negative, come ad esempio i tunnel di congelamento a -40 °C. Costituita da soli 3 elementi, caratteristica comune nella nostra produzione, consente una estrema facilità di montaggio e viene utilizzata su pareti dove mancando lo spazio per lo scorrimento orizzontale si dispone di quello in verticale.

La porta può essere fornita con:

- rivestimento versione "standard" in lamiera zinco plastificata;
- rivestimento in acciaio inox;
- rivestimento in acciaio inox e vetroresina.

COLDTECH

Via Riviera 136/2 - 10040 Almese (TO)
Tel. 0119370518 - Fax 0119319297
coldtech@coldtech.it - www.coldtech.tech



Vertical sliding door.

The vertical sliding door, manual or automatic operating, is suitable for all types of cold storage rooms and even freezing one such as freezing tunnels at -40 °C. This kind of door is composed by only three elements, common characteristic of our production, making the fitting very easy. The application of this door is wherever there is not room enough for an horizontal sliding, but with a sufficient one vertically.

The door could be supplied with the following cladding:

- standard one, i.e. with galvanized plastified metal sheet;
- stainless steel;
- fiberglass.

Porte mod. "A Guillotine".

La porte coulissante verticale, est indiquée pour tous les types de chambres frigorifiques, positives ou negatives, comme par exemple tunnel de congélation à -40 °C. Composée, seulement, de 3 éléments, caractéristique commune de notre production, elle est très facile à installer et peut être utilisée sur parois où il y a l'espace seulement pour le coulissement vertical et pas horizontal.

La porte peut être fabriquée avec:

- revêtement "standard" tôle plastifiée;
- revêtement tôle acier inox;
- revêtement tôle acier inox et polyester moulé.



MODELLO GHIGLIOTTINA

Vertical sliding door
Porte mod. "A Guillotine".

Caratteristiche tecniche

A	Battente della porta isolato con poliuretano espanso iniettato.
B	Guarnizioni di tenuta in gomma elastica.
C	Telaio rivestito con lamiera di acciaio plastificata.
D	Parete.
E	Sistema di sicurezza a "paracadute".
F	Contrappeso.
G	Guide di scorrimento in alluminio anodizzato.
L	Catena di collegamento battente contrappeso

Technical features

A	Door wing insulated with injected polyurethane foam.
B	Elastic rubber strips.
C	Frame covered with plastified steel sheet.
D	Wall.
E	Falling prevention safety device.
F	Counterweight.
G	Anodized Aluminium guides.
L	Doorblade counterweight connecting chain.

HT = 2H + 560 mm

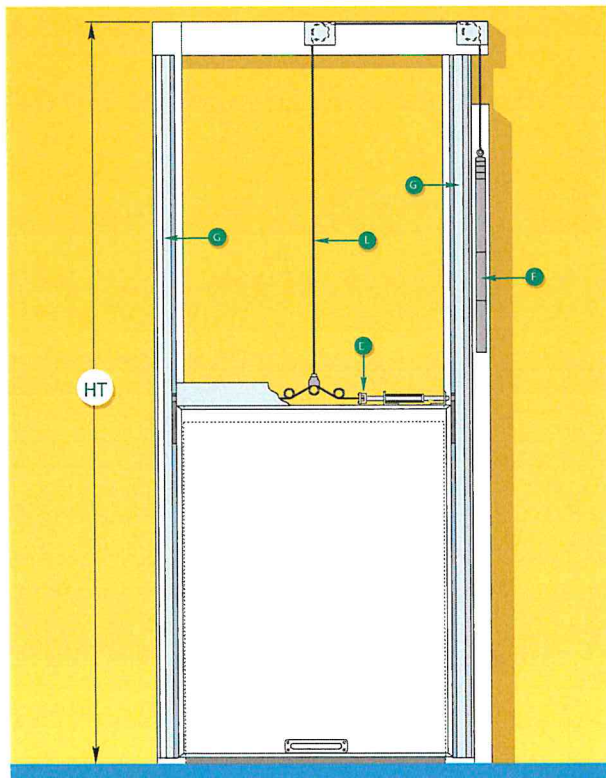

HB = H + 135

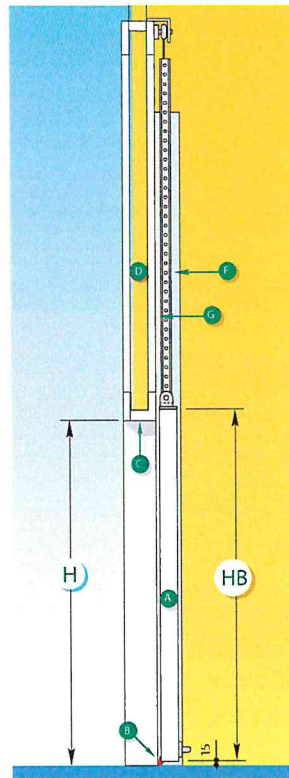

LT = L + 450 mm

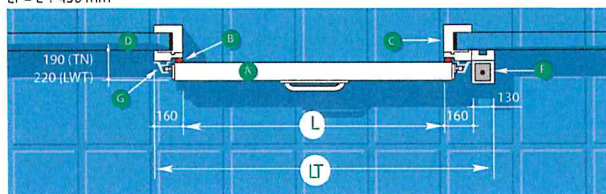

Caracteristiques techniques

A	Vantail de la porte isolé par injection de polyuréthane.
B	Joints d'étanchéité en caoutchouc élastique.
C	Dormant en bois dur recouvert en tôle plastifiée.
D	Paroi.
E	Système de sûreté a "parachute".
F	Contrepoids.
G	Guide de coulissement en aluminium anodisé.
L	Chaîne de liaison vantail/contrepoids.

COLDTECH



Porta scorrevole manuale

Atmosfera controllata



 Manual sliding door
Controlled atmosphere

 Portes coulissantes manuelles
Atmosphère Contrôlée

 Puertas correderas manuales
Atmósfera Controlada

Porta scorrevole manuale

Atmosfera controllata

Caratteristiche - Caractéristiques - Features - Características

$H = L1 + 100$

$H = H1 + 50$

$L_A = L \times 2 + 480$

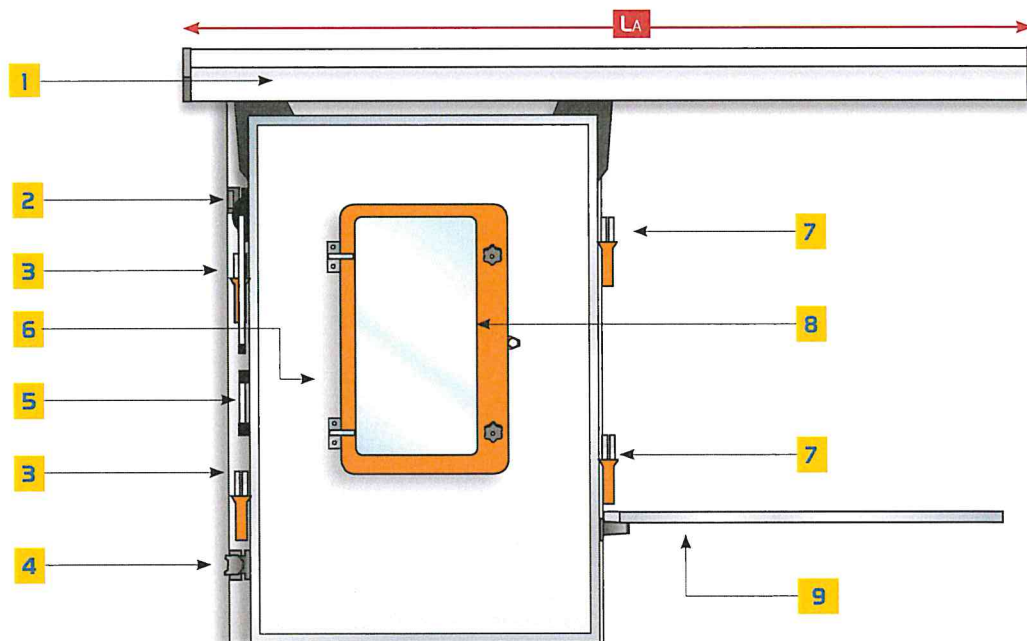

Particolare di uno dei volantini di serraggio

- Detail of a tightening handwheel
- Détail d'un des volants de serrage
- Detalle de una de las ruedas de sujeción

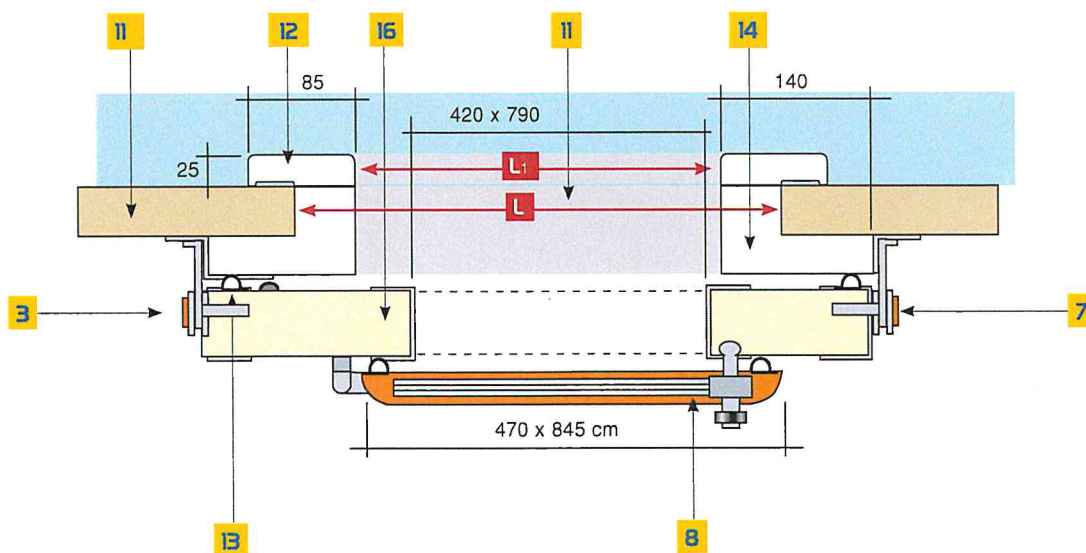

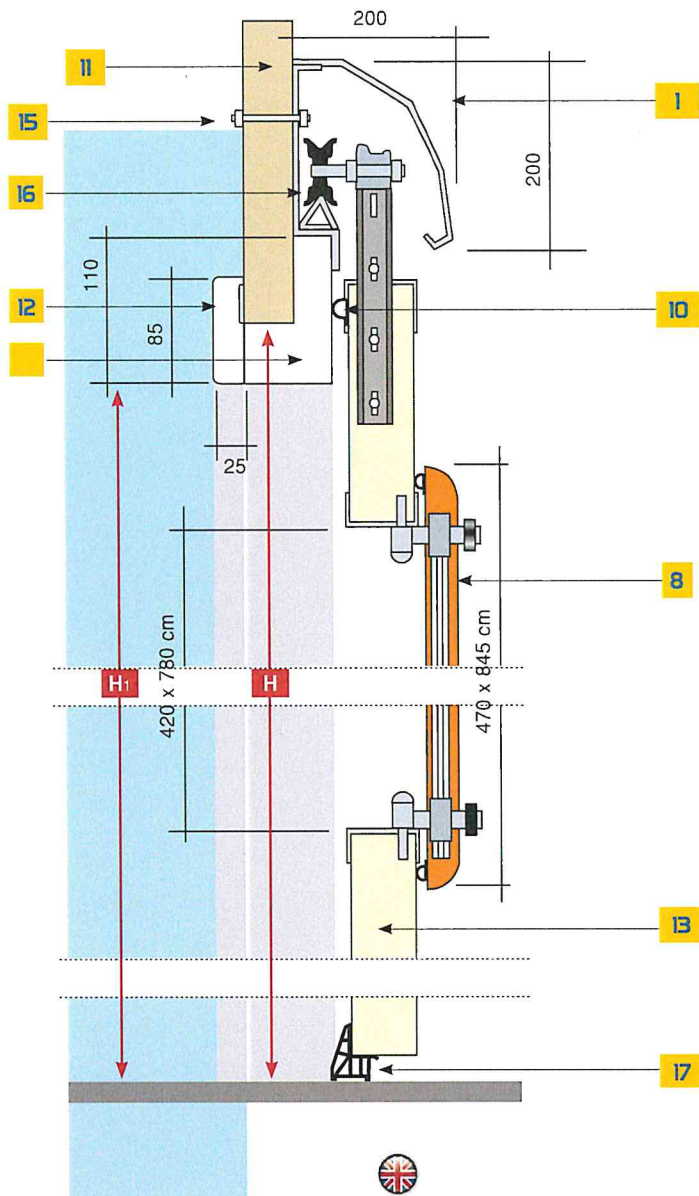

Oblo standard 470 x 845 cm con vetro termico a doppia camera

- Standard porthole 470 x 845 cm with double thermal glass
- Standard hublot 470 x 845 en verre à double chambre de la chaleur
- Ventanilla estándar 470 x 845 cm con vidrio térmico

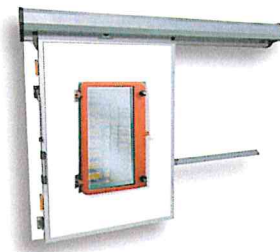

Caratteristiche	Features	Caractéristiques	Características
1 Copertina per porta scorrevole	Cover for sliding door	Couverture pour porte coulissante	Cubierta para puerta corredera
2 Maniglia esterna a leva in INOX	Hand external lever handle in stainless steel	Poignée externe a levier inox	Manilla externa de palanca inox
3 Gancio eccentrico per ATC SX	Eccentric hook for ATC SX	Crochet excentrique pour l'ATC SX	Gancho excéntrico para el ATC SX
4 Gancio di chiusura inferiore	Lower latch hook	Crochet de fermeture inférieur	Gancho de cierre inferior
5 Maniglia esterna fissa laterale	Fixed external side handle	Poignée externe fixe laterale	Manilla externa fija lateral
6 Cerniera reversibile a rampa	Reversible ramp hinge	Charnière réversible à rampe	Bisagra reversible a rampa
7 Gancio eccentrico per ATC DX	Eccentric hook for ATC DX	Crochet excentrique pour l'ATC DX	Gancho excéntrico para el ATC DX
8 Sportello con telaio per ATC	Glass view window with frame for ATC	Hublot en verre avec cadre pour l'ATC	Ventana de cristal con marco de ATC
9 Guida inferiore	Lower guide	Guide inférieur	Guía inferior
10 Guarnizione	Seal	Garniture	Burlete
11 Parete	Wall	Mur	Pared
12 Contro telaio	Counter frame	Contre-châssis	Contra bastidor
13 Pannello porta in poliuretano espanso	Polyurethane door panel	Panneau avec de la mousse de polyuréthane	Puerta del panel de espuma de poliuretano
14 Telaio	Frame	Cadre	Bastidor
15 Tirante in PVC	PVC closing brace	Tirant PVC	Tirante PVC
19 Carrucola completa in plastica	Complete plastic sheave	Poulie complète en plastique	Garrucha completa de plástico
20 Guarnizione filo-pavimento	Seal at floor level	Garniture ras du sol	Burlete a ras de suelo

Porta scorrevole manuale

Atmosfera controllata in kit di montaggio



Manual sliding door

Controlled atmosphere cold storage door in assembly kit



Portes coulissantes manuelles

Atmosphère Contrôlée kit d'assemblage



Puertas correderas manuales

Puerta frigorífica atmósfera controlada en kit de montaje

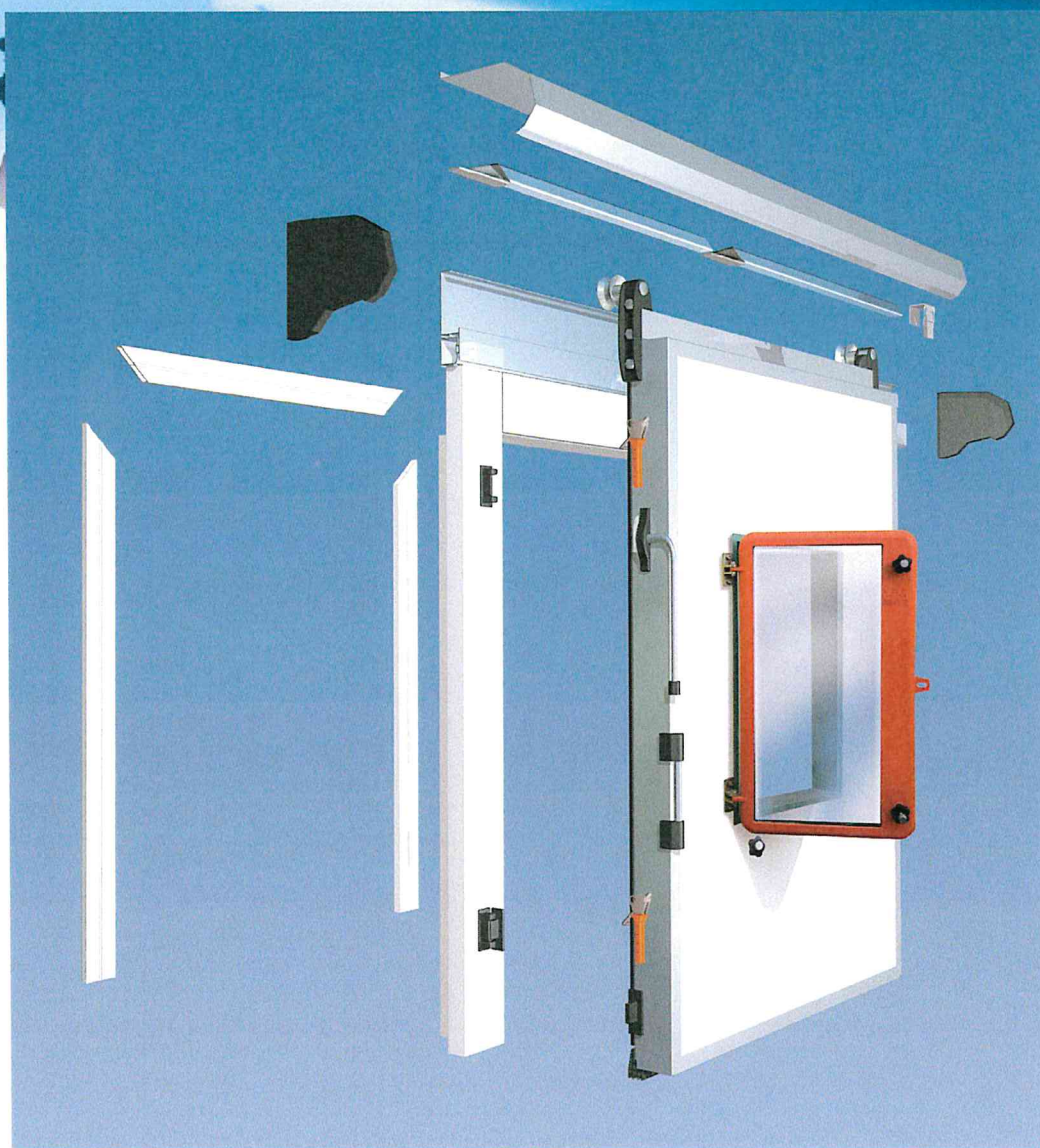

COLDTECH

Via Rivera 136/2 - 10040 Almese (TO) - Italy
Tel. ++39 011. 9370518

www.coldtech.tech