

DOGA

plinth for external walls

ORIZZONTI

coatings for external walls



 **IMER**<sup>®</sup>

INDUSTRY FOR BUILDING PRODUCTS

**TÜV**  
AUSTRIA  
EN ISO 9001:2015  
No.: 20001210004370



THE EXCELLENCE  
BETWEEN NATURE,  
QUALITY AND  
TECHNOLOGY

# New Horizon in the field of Wall Coatings...

**DOGA** and **ORIZZONTI**, two further innovations in the field of wall coatings, born from our orientation towards the creation of new products able to combine efficiency, functionality and elegance.

Efficiency thanks to their wear and weather resistance, in order to protect external walls; functionality thanks to their easy application; elegance for their simil marble texture and for their thin thickness that let them to be an eye-catching decorative element too...

**SUPER PRESSED**



**FINISHING  
SIMILMARBLE  
SUPERSMOOTHED**



**WATER  
RESISTANT**



**ANTIFREEZE**



**FAST**

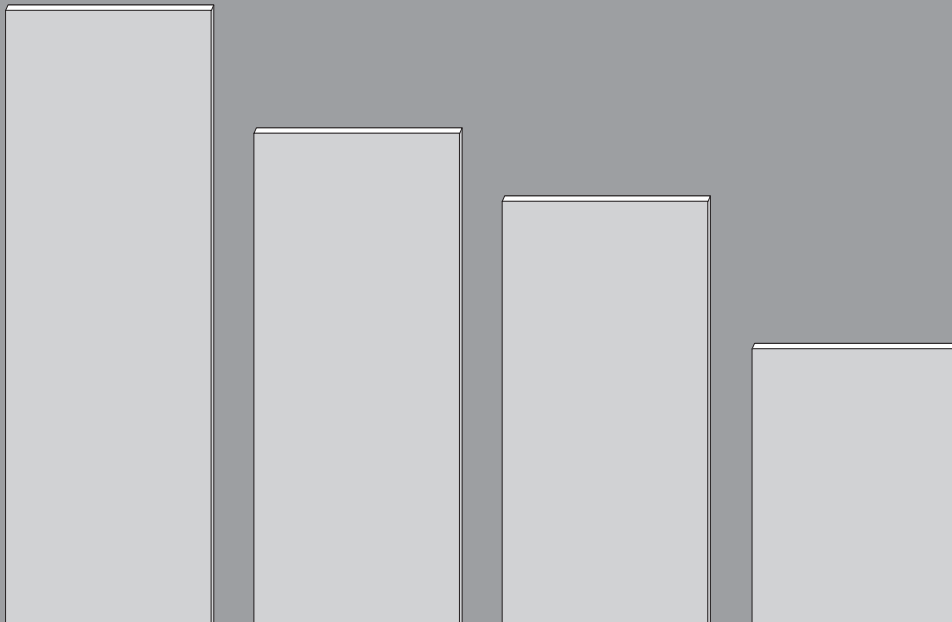

DOGA

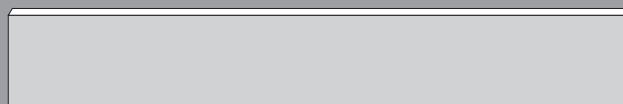
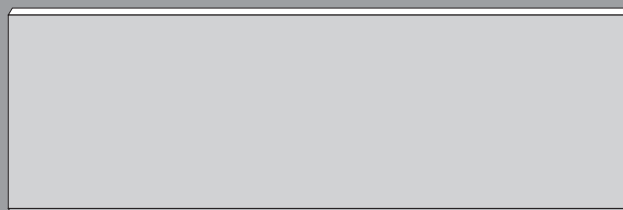

ORIZZONTI

# 30 YEARS OF INNOVATIONS...

30 Years of Experience and Know-how in the production and processing of building products let **IMER Srl** be a company strongly oriented to the product's and service's excellence, with a view to profitable relations with the National and International market. The obsessive attention to product excellence, the impulse for innovation have been the foundations and the keys that have transformed the dream of a very young entrepreneur into reality.

Sands from natural stones, marble grits: only **natural materials rigorously selected for products of high quality and aesthetic profile** able to respond to the requests and needs of an increasingly demanding and qualified market. These are the values on which Imer Srl shapes its Mission.

The high quality profile is a constant in its production, thanks to **the careful selection of local raw materials**, to the application of the most updated working and production methods that spring from the experience got from 30 years of experience, to a **structured organization** and a **qualified Team** that guarantee quality and efficiency from the production departments to the commercial and distribution network.

All that establishes the competitive advantage of **IMER Srl** - ISO 9001 certified company - and guarantee production capacity, quality control and well-made products, functional and practical in terms of application and maintenance; unique products thanks to the care we put in the finishing phase.



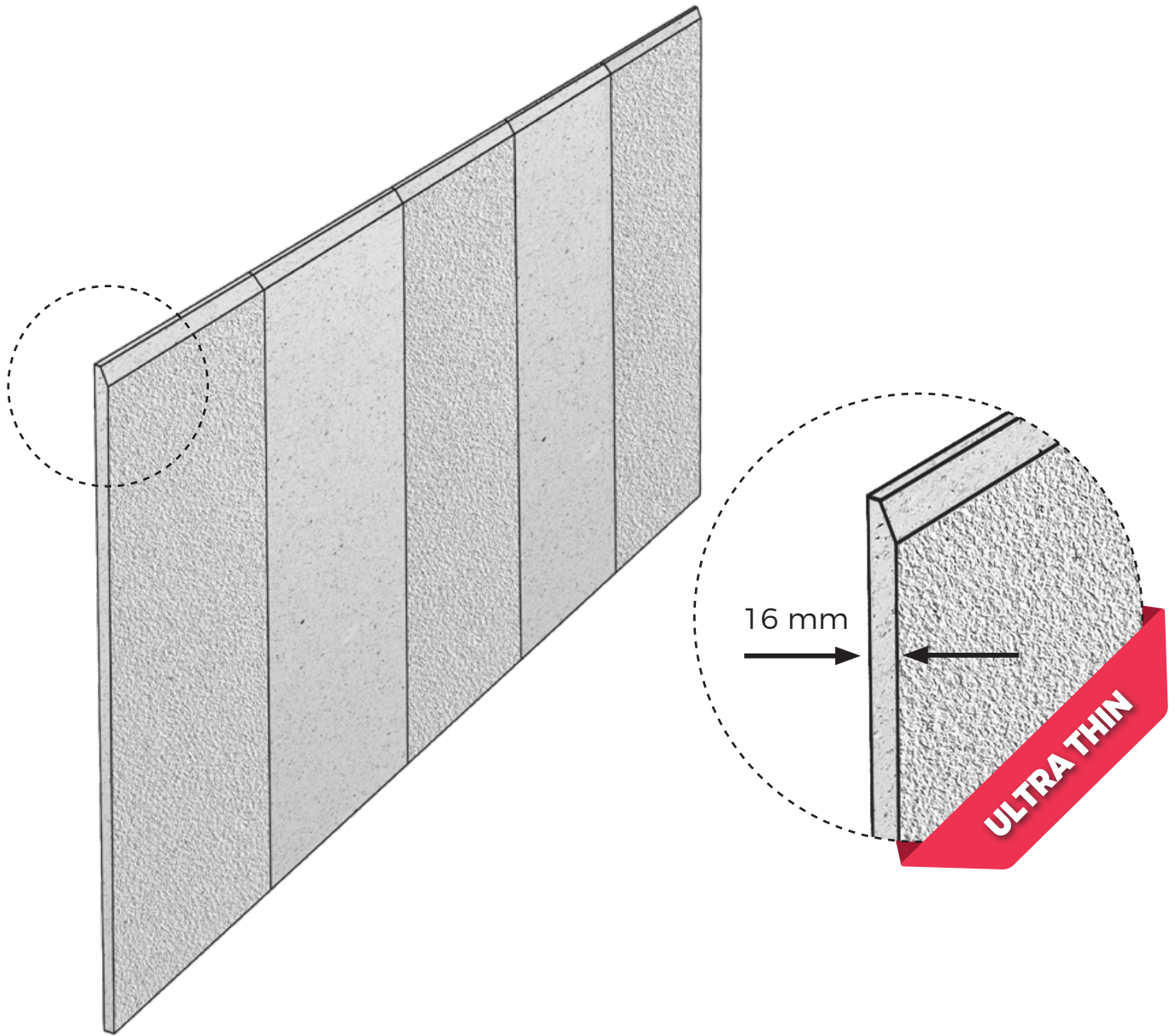

LIGHT  
GREY

WHITE

YELLOW

SMOOTHED

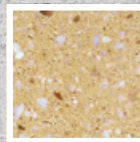
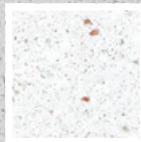
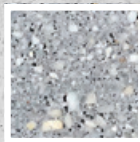

LIGHT  
GREY

WHITE

YELLOW

BUSH-HAMMERED

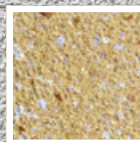
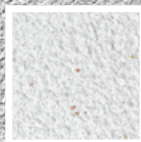
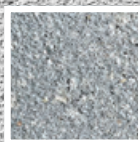

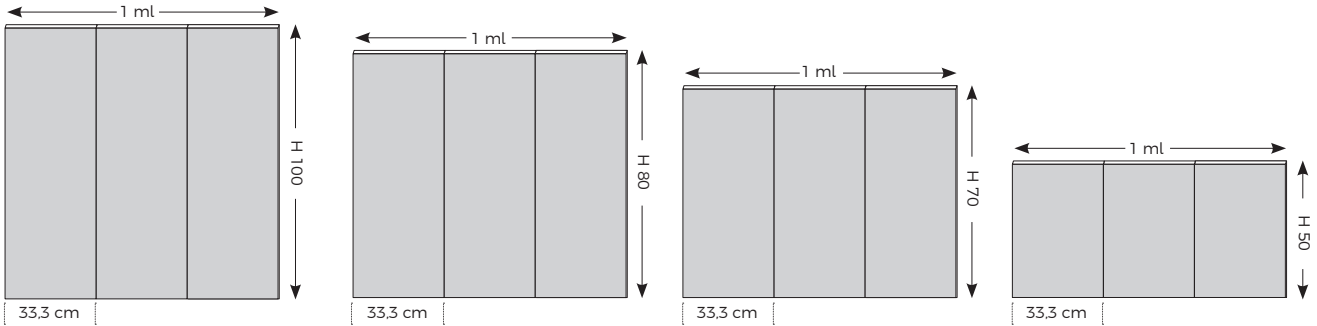

| ART.                       | COD.      | MIS.         | Weight per pcs. | Wooden |      | available colours   |   |   |
|----------------------------|-----------|--------------|-----------------|--------|------|---|---|---|
| <b>DOGA H 100 SMOOTHED</b> | DG/100/LV | Cm           | Kg              | ML     | Pcs. | LIGHT GREY  | WHITE   | YELLOW  |
|                            |           |              |                 | 42     | 126  |    |    |    |
|                            |           | 33,3x100 (h) | 10,750          |        |      | ✓   | ✓   | ✓   |
| <b>DOGA H 80 SMOOTHED</b>  | DG/80/LV  | Cm           | Kg              | ML     | Pcs. | LIGHT GREY  | WHITE   | YELLOW  |
|                            |           |              |                 | 42     | 126  |    |    |    |
|                            |           | 33,3x80 (h)  | 8,750           |        |      | ✓   | ✓   | ✓   |
| <b>DOGA H 70 SMOOTHED</b>  | DG/70/LV  | Cm           | Kg              | ML     | Pcs. | LIGHT GREY  | WHITE   | YELLOW  |
|                            |           |              |                 | 42     | 126  |  |  |  |
|                            |           | 33,3x70 (h)  | 6,750           |        |      | ✓   | ✓   | ✓   |
| <b>DOGA H 50 SMOOTHED</b>  | DG/50/LV  | Cm           | Kg              | ML     | Pcs. | LIGHT GREY  | WHITE   | YELLOW  |
|                            |           |              |                 | 66     | 198  |  |  |  |
|                            |           | 33,3x50 (h)  | 5,400           |        |      | ✓   | ✓   | ✓   |

| ART.                            | COD.      | MIS.         | Weight per pcs. | Wooden |      | available colours   |   |   |
|---------------------------------|-----------|--------------|-----------------|--------|------|---|---|---|
| <b>DOGA H 100 BUSH-HAMMERED</b> | DG/100/BC | Cm           | Kg              | ML     | Pcs. | LIGHT GREY  | WHITE   | YELLOW  |
|                                 |           |              |                 | 42     | 126  |  |  |  |
|                                 |           | 33,3x100 (h) | 10,700          |        |      | ✓   | ✓   | ✓   |
| <b>DOGA H 80 BUSH-HAMMERED</b>  | DG/80/BC  | Cm           | Kg              | ML     | Pcs. | LIGHT GREY  | WHITE   | YELLOW  |
|                                 |           |              |                 | 42     | 126  |  |  |  |
|                                 |           | 33,3x80 (h)  | 8,600           |        |      | ✓   | ✓   | ✓   |
| <b>DOGA H 70 BUSH-HAMMERED</b>  | DG/70/BC  | Cm           | Kg              | ML     | Pcs. | LIGHT GREY  | WHITE   | YELLOW  |
|                                 |           |              |                 | 42     | 126  |  |  |  |
|                                 |           | 33,3x70 (h)  | 6,600           |        |      | ✓   | ✓   | ✓   |
| <b>DOGA H 50 BUSH-HAMMERED</b>  | DG/50/BC  | Cm           | Kg              | ML     | Pcs. | LIGHT GREY  | WHITE   | YELLOW  |
|                                 |           |              |                 | 66     | 198  |  |  |  |
|                                 |           | 33,3x50 (h)  | 5,250           |        |      | ✓   | ✓   | ✓   |

✓ available colour

# ORIZZONTI

coatings for external walls

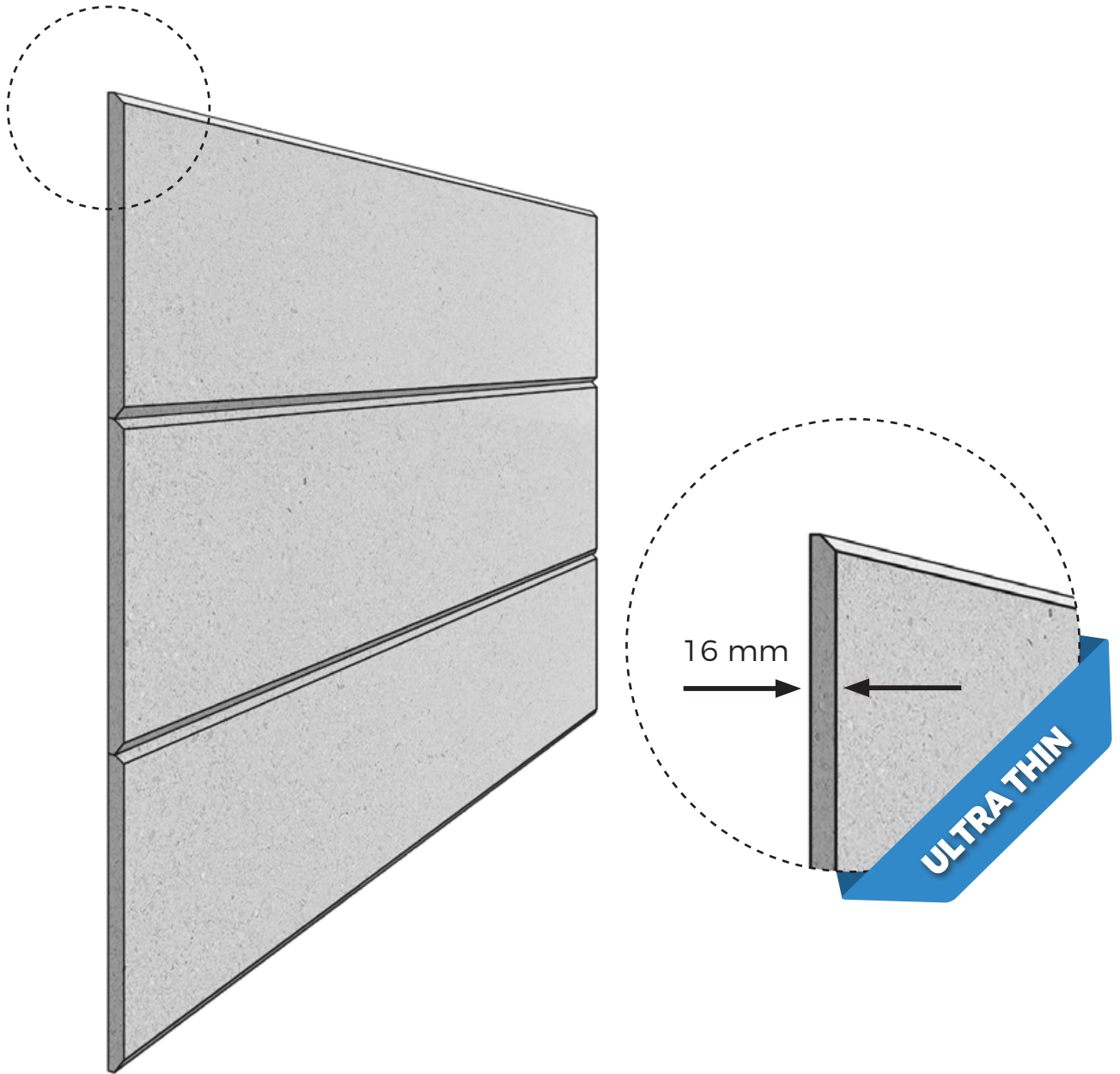

LIGHT  
GREY

WHITE

YELLOW

SMOOTHED

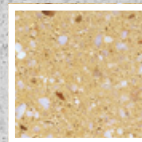
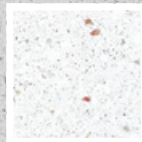
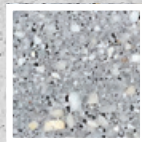

LIGHT  
GREY





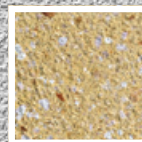
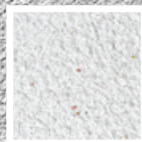
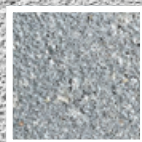

WHITE

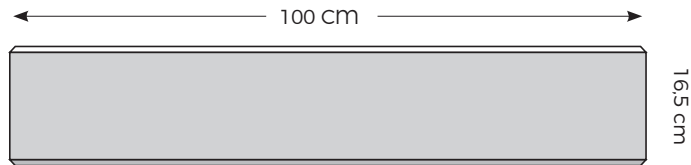
YELLOW







BUSH-HAMMERED

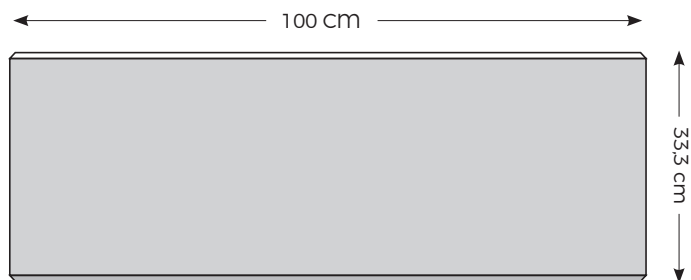



| ART.  | COD.       | MIS. | Weight per pcs. | Wooden |      | available colours   |   |   |
|---|------------|------|-----------------|--------|------|---|---|---|
| <b>ORIZZONTI<br/>H 16,5<br/>SMOOTHED</b>      | OR/16,5/LV | Cm   | Kg              | Mq     | Pcs. | LIGHT GREY  | WHITE   | YELLOW  |
|   |            |      |                 | 42     | 252  |    |    |    |
|   |            |      |                 |        |      | ✓   | ✓   | ✓   |
| <b>ORIZZONTI<br/>H 16,5<br/>BUSH-HAMMERED</b> | OR/16,5/BC | Cm   | Kg              | Mq     | Pcs. | LIGHT GREY  | WHITE   | YELLOW  |
|   |            |      |                 | 42     | 252  |  |  |  |
|   |            |      |                 |        |      | ✓   | ✓   | ✓   |



| ART.  | COD.       | MIS. | Weight per pcs. | Wooden |      | available colours   |   |   |
|---|------------|------|-----------------|--------|------|---|---|---|
| <b>ORIZZONTI<br/>H 33,3<br/>SMOOTHED</b>      | OR/33,3/LV | Cm   | Kg              | Mq     | Pcs. | LIGHT GREY  | WHITE   | YELLOW  |
|   |            |      |                 | 42     | 126  |  |  |  |
|   |            |      |                 |        |      | ✓   | ✓   | ✓   |
| <b>ORIZZONTI<br/>H 33,3<br/>BUSH-HAMMERED</b> | OR/33,3/BC | Cm   | Kg              | Mq     | Pcs. | LIGHT GREY  | WHITE   | YELLOW  |
|   |            |      |                 | 42     | 126  |  |  |  |
|   |            |      |                 |        |      | ✓   | ✓   | ✓   |

✓ available colour

# ACCESSORIES

## FRAME ELITE in cement smoothed and water resistant for external walls

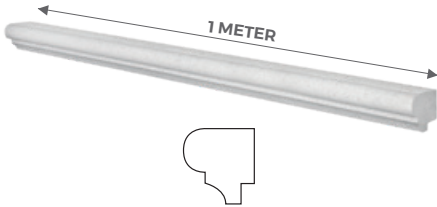

1 piece per ML laid

| ART.     | MIS.<br>Cm  | Weight per pcs.<br>Kg | Wooden |      | available colours |       |        |
|----------|-------------|-----------------------|--------|------|-------------------|-------|--------|
|          |             |                       | ML     | Pcs. | LIGHT GREY        | WHITE | YELLOW |
| TS/EL/01 | 100x5,5x4,5 | 4,5                   | 120    | 120  | ✓                 | ✓     | ✓      |

## FRAME EVO in cement smoothed and water resistant for EXTERNAL WALLS

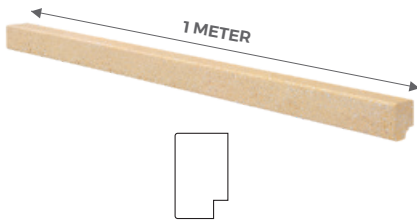

1 piece per ML laid

| ART.     | MIS.<br>Cm | Weight per pcs.<br>Kg | Wooden |      | available colours |       |        |
|----------|------------|-----------------------|--------|------|-------------------|-------|--------|
|          |            |                       | ML     | Pcs. | LIGHT GREY        | WHITE | YELLOW |
| TS/EV/01 | 100x5x2,5  | 2,5                   | 120    | 120  | ✓                 | ✓     | ✓      |

✓ available colour



## **LAYING AND GENERAL MAINTENANCE WARNINGS**

In order to guarantee a long lasting life to the wall coping we advise to carry out, after the laying, a protective treatment on all the surface with a water resistant and perspiring product, which has to be transparent. Please, clean the surface before making it and spread it evenly on all sides. Our products, due to the fact that are produced using natural aggregates, carved, from local stones, could have different shades of colours.

## **GENERAL LAYING INSTRUCTIONS**

**Preparation of the laying surface:** 1) clean the wall with water after having removed any kind of impurity; 2) let it dry; 3) remove carefully residual dust; 4) make sure there are no difference in level on the upper part of the wall.

**Laying:** 1) do not use classic cement mortar, in order to avoid the wall coping coming off over time; 2) use specific glues, following the manufacturer instructions; 3) keep between one wall coping and the other one a distance of about 1,5/2 mm. and use high quality wall putty following the manufacturer instructions; 4) do not use classic cement mortar as wall putty; make sure there are not less than 5 mm of air between plaster and drip; 5) Putty close to the hole around the fence post, avoiding placing more than 5 mm of putty around the fence post. **Safety:** Adopt the safety devices and regulations in force



**INDUSTRY FOR BUILDING PRODUCTS**

**IMER srl**

Zona Industriale

73024 Maglie (Le) - ITALY

Phone / Fax +39 0836.42.35.07

Phone +39 0836.31.58.14

[commerciale@imeritalia.it](mailto:commerciale@imeritalia.it)

**[imeritalia.it](http://imeritalia.it)**

---

*UNI EN ISO 9001:2015*  
*Certified Company*

