

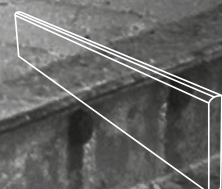

INDUSTRY FOR BUILDING PRODUCTS

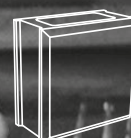
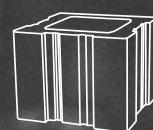

PRICELIST N°1 2022

MADE IN ITALY



THE EXCELLENCE
BETWEEN
NATURE,
QUALITY AND
TECHNOLOGY



30 YEARS OF INNOVATION...

30 Years of Experience and Know-how in the production and processing of building products let **IMER Srl** be a company strongly oriented to the product's and service's excellence, with a view to profitable relations with the National and International market. The obsessive attention to product excellence, the impulse for innovation have been the foundations and the keys that have transformed the dream of a very young entrepreneur into reality.

Sands from natural stones, marble grits: only **natural materials rigorously selected for products of high quality and aesthetic profile** able to respond to the requests and needs of an increasingly demanding and qualified market. These are the values on which Imer Srl shapes its Mission.

The high quality profile is a constant in its production, thanks to the **careful selection of local raw materials**, to the application of the most updated working and production methods that spring from the experience got from 30 years of experience, to a **structured organization** and a **qualified Team** that guarantee quality and efficiency from the production departments to the commercial and distribution network.

All that establishes the competitive advantage of **IMER Srl** ✓ ISO 9001 certified company – and guarantee production capacity, quality control and well-made products, functional and practical in terms of application and maintenance; unique products thanks to the care we put in the finishing phase.



30
YEARS
OF EXPERIENCE



32 EMPLOYEES



QUALITY
CONTROL
360°



8 COUNTRIES
IN THE WORLD
WHERE WE
ARE PRESENT



6
PRODUCTION
PLANTS



40.000 MQ
PRODUCTS AND STORAGE AREA

 **IMER**[®]

MADE IN ITALY

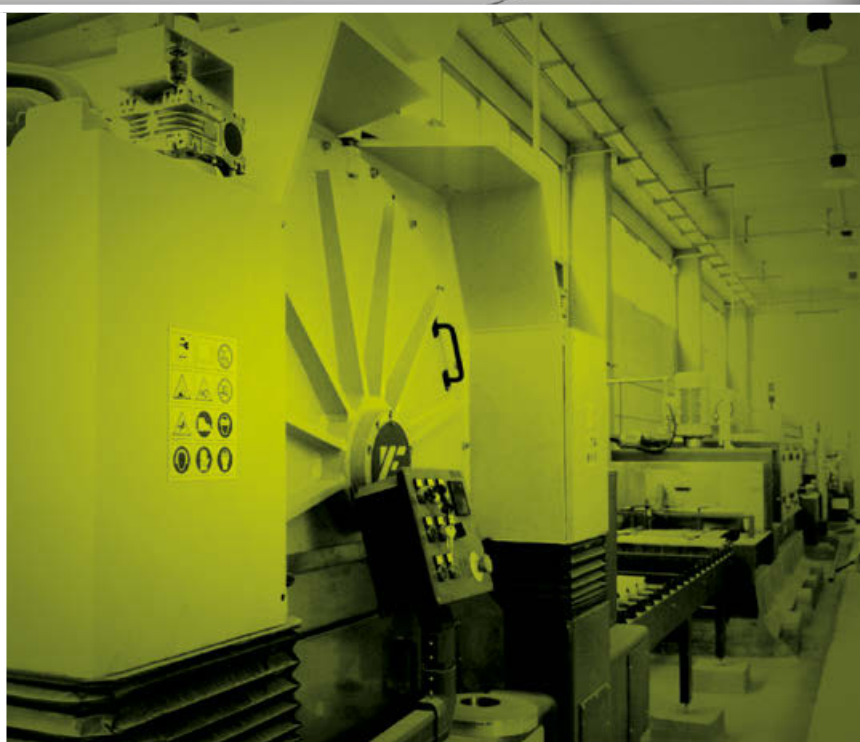
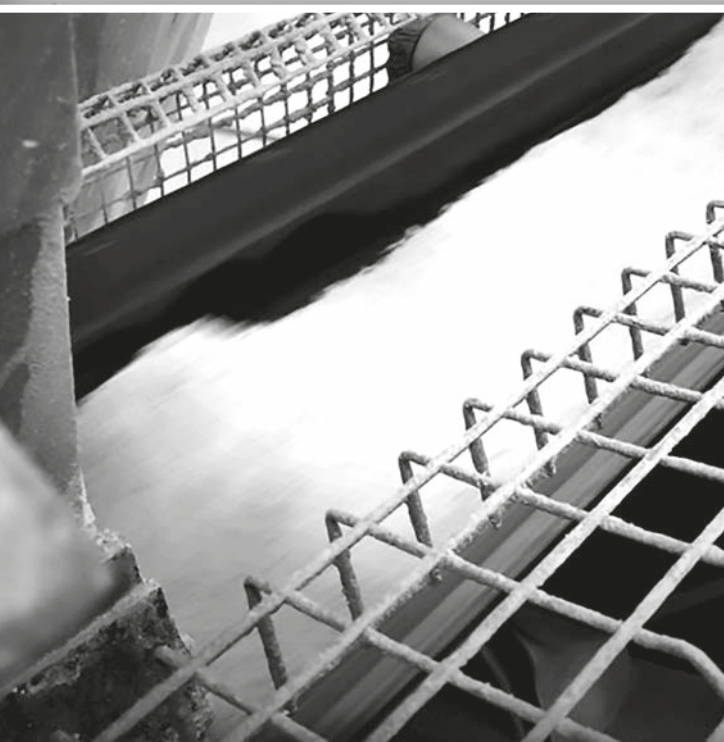



Classic Wall Coping
and its accessories



Step and
its accessories



Column Cap



Wall Coatings



Biocarparo line

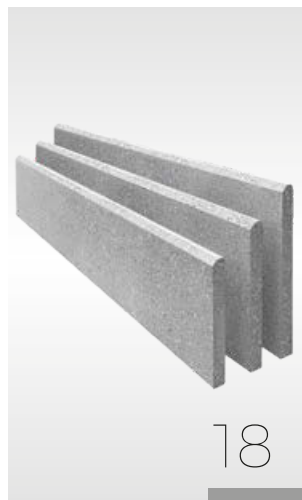

Meter long Baseboard



Fences



Fences Horizon

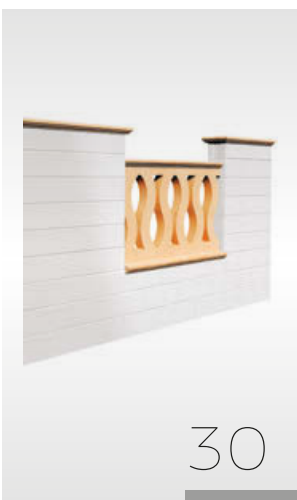

Blocks



Natural Border Sidewalk



LIGHT
GREY



DARK
GREY



RED

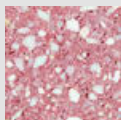

WHITE



YELLOW



LIGHT
SALMON



WALL COPING in cement supersmoothed coloured and water resistant

4 pieces per ML

	ART.	INT. MEA		PALLET		available colours								
		Cm	Kg	ML	Pcs	LIGHT GREY	DARK GREY	RED	WHITE	YELLOW	LIGHT SALMON			
														
														
	CM/01	10,5	4,5	80	320	✓	✓	✓	✓	✓	✓	✓	✓	✓
	CM/02	11,5	5	80	320	✓	✓	✓	✓	✓	✓	✓	✓	✓
	CM/08	14,0	5,5	72	288	✓	✓	✓	✓	✓	✓	✓	✓	✓
	CM/03	16,5	5,7	60	240	✓	✓	✓	✓	✓	✓	✓	✓	✓
	CM/04	18,5	6,2	60	240	✓	✓	✓	✓	✓	✓	✓	✓	✓
	CM/05	22,0	6,8	54	216	✓	✓	✓	✓	✓	✓	✓	✓	✓
	CM/09	24,0	7,5	54	216	✓	✓	✓	✓	✓	✓	✓	✓	✓
	CM/06	27,0	7,9	44	176	✓	✓	✓	✓	✓	✓	✓	✓	✓
	CM/07	32,0	8,6	40	160	✓	✓	✓	✓	✓	✓	✓	✓	✓

15% surcharge for unpalletised goods

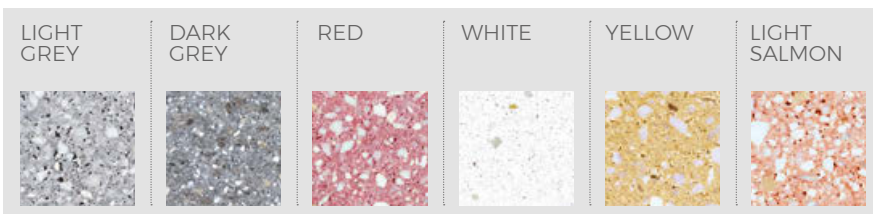

WALL COATING

SPECIAL PIECES

CORNER in cement supersmoothed coloured and water resistant

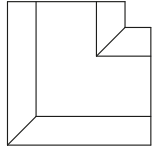

ART.	INT. MEA. weight per pcs.		PALLET	available colours					
	Cm	Kg		Pcs	LIGHT GREY	DARK GREY	RED	WHITE	YELLOW
CM/A/01	10,5	5,0	60	✓	✓	✓	✓	✓	✓
CM/A/02	11,5	5,5	60	✓	✓	✓	✓	✓	✓
CM/A/08	14,0	6,1	60	✓	✓	✓	✓	✓	✓
CM/A/03	16,5	11,8	60	✓	✓	✓	✓	✓	✓
CM/A/04	18,5	12,8	60	✓	✓	✓	✓	✓	✓
CM/A/05	22,0	14,5	60	✓	✓	✓	✓	✓	✓
CM/A/09	24,0	14,6	60	✓	✓	✓	✓	✓	✓
CM/A/06	27,0	16,9	60	✓	✓	✓	✓	✓	✓
CM/A/07	32,0	17,5	60	✓	✓	✓	✓	✓	✓

HEADBOARD in cement supersmoothed coloured and water resistant

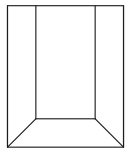

ART.	INT. MEA. weight per pcs.		PALLET	available colours					
	Cm	Kg		Pcs	LIGHT GREY	DARK GREY	RED	WHITE	YELLOW
CM/T/01	10,5	5,0	60	✓	✓	✓	✓	✓	✓
CM/T/02	11,5	5,5	60	✓	✓	✓	✓	✓	✓
CM/T/08	14,0	6,0	60	✓	✓	✓	✓	✓	✓
CM/T/03	16,5	6,2	60	✓	✓	✓	✓	✓	✓
CM/T/04	18,5	6,8	60	✓	✓	✓	✓	✓	✓
CM/T/05	22,0	7,3	60	✓	✓	✓	✓	✓	✓
CM/T/09	24,0	8,0	60	✓	✓	✓	✓	✓	✓
CM/T/06	27,0	8,4	60	✓	✓	✓	✓	✓	✓
CM/T/07	32,0	9,1	60	✓	✓	✓	✓	✓	✓

STEP



MADE IN ITALY



LIGHT
GREY



DARK
GREY



RED

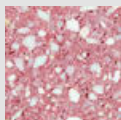

WHITE



YELLOW



LIGHT
SALMON



STEP

STEP in cement supersmoothed coloured and water resistant

4 pieces per ML

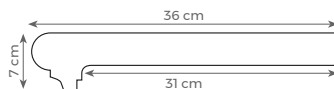

ART.	INT. MEA		PALLET		available colours					
	Cm	Kg	ML	Pcs	LIGHT GREY	DARK GREY	RED	WHITE	YELLOW	LIGHT SALMON
GR/01	31,0	7,0	68	272	✓	✓	✓	✓	✓	✓

15% surcharge for unpalletised goods

STEP CORNER in cement supersmoothed coloured and water resistant

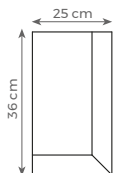

ART.	INT. MEA		PALLET		available colours					
	Cm	Kg	Pcs		LIGHT GREY	DARK GREY	RED	WHITE	YELLOW	LIGHT SALMON
GR/AD/01	31x20	7,3	60		✓	✓	✓	✓	✓	✓
GR/AS/01	31x20	7,3	60		✓	✓	✓	✓	✓	✓

NEWS

FLOOR in cement supersmoothed coloured and water resistant

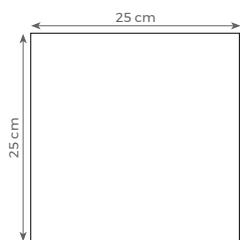

ART.	MEA		PALLET		available colours					
	Cm	Kg	Mq ^{Ped}	Pcs ^{Mq}	LIGHT GREY	DARK GREY	RED	WHITE	YELLOW	LIGHT SALMON
PVSL/01	25x25x1,7	2,20	48	16	✓	-	-	-	-	-
PVSL/02	25x25x1,7	2,20	48	16	-	✓	-	-	-	-
PVSL/03	25x25x1,7	2,20	48	16	-	-	✓	-	-	-
PVSL/04	25x25x1,7	2,20	48	16	-	-	-	✓	-	-
PVSL/05	25x25x1,7	2,20	48	16	-	-	-	-	✓	-
PVSL/06	25x25x1,7	2,20	48	16	-	-	-	-	-	✓



COLUMN CAPITAL

COLUMN CAPITAL* in cement smoothed coloured and water resistant

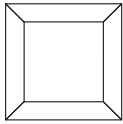

ART.	INT. MEA. Cm	Base Cm	Weight per pcs. Kg	available colours				
				LIGHT GREY	RED	WHITE	YELLOW	LIGHT SALMON
TIPO 25	33x33	28x28	15,5	✓	✓	✓	✓	✓
TIPO 30	38x38	33x33	20,3	✓	✓	✓	✓	✓
TIPO 35	43x43	38x38	26,5	✓	✓	✓	✓	✓
TIPO 40	48x48	43x43	34,2	✓	✓	✓	✓	✓

* full cap got from the block

EXTERNAL FRAME® smoothed and water resistant

2 pieces per ML



ART.	MEA Cm	Weight per pcs Kg	PALLET		available colours						
			ML	Pcs	CARPARO YELLOW	WHITE MEDITERR.	LIGHT GREY	RED	WHITE	YELLOW	LIGHT SALMON
TS/01	50x4,5x6	2,5	200	400	✓	-	-	-	-	-	-
TS/02	50x4,5x6	2,5	200	400	-	✓	-	-	-	-	-
TS/04	50x4,5x6	2,5	200	400	-	-	✓	-	-	-	-
TS/05	50x4,5x6	2,5	200	400	-	-	-	✓	-	-	-
TS/06	50x4,5x6	2,5	200	400	-	-	-	-	✓	-	-
TS/07	50x4,5x6	2,5	200	400	-	-	-	-	-	✓	-
TS/08	50x4,5x6	2,5	200	400	-	-	-	-	-	-	✓

BASEBOARD in cement smoothed coloured and water resistant

2 pcs per ML

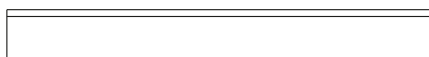

ART.	MEA Cm	Weight per pcs Kg	PALLET		available colours				
			ML	Pz	LIGHT GREY	RED	WHITE	YELLOW	LIGHT SALMON
BT/01	50x10x1,5	1,5	150	300	✓	✓	✓	✓	✓



EXTERNAL WALL COATING® smoothed and water resistant

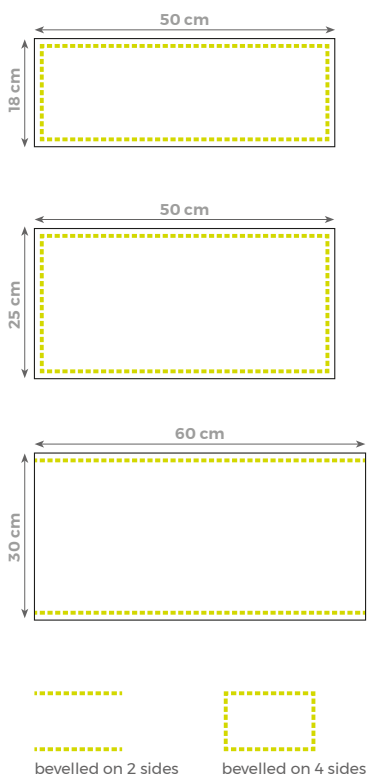

♦ *supersmoothed finishing*

ART.	MEA Cm	Weight Kg	PALLET		available colours							
			Mq ^{Ped}	Pz ^{Mq}	GIALLO CARPARO	BIANCO MEDITERR.	GRIGIO PERLACEO	ROSSO TERRA	BIANCO ROCCIA	GIALLO TUFO	SALMONE CHIARO	
RS/01	50x18x1,3	2,0	48	11	✓							
RS/001	50x25x1,3	3,0	48	8	✓	-	-	-	-	-	-	-
♦ RSC/01	60x30x1,7	6,2	36	5,5	✓							
RS/02	50x18x1,3	2,0	48	11		✓						
RS/002	50x25x1,3	3,0	48	8	-	✓	-	-	-	-	-	-
♦ RSC/02	60x30x1,7	6,2	36	5,5		✓						
RS/04	50x18x1,3	2,0	48	11			✓					
RS/004	50x25x1,3	3,0	48	8	-	-	✓	-	-	-	-	-
♦ RSC/04	60x30x1,7	6,2	36	5,5			✓					
RS/05	50x18x1,3	2,0	48	11				✓				
RS/005	50x25x1,3	3,0	48	8	-	-	-	✓	-	-	-	-
♦ RSC/05	60x30x1,7	6,2	36	5,5				/				
RS/06	50x18x1,3	2,0	48	11					✓			
RS/006	50x25x1,3	3,0	48	8	-	-	-	-	✓	-	-	-
♦ RSC/06	60x30x1,7	6,2	36	5,5					✓			
RS/07	50x18x1,3	2,0	48	11						✓		
RS/007	50x25x1,3	3,0	48	8	-	-	-	-	-	✓	-	-
♦ RSC/07	60x30x1,7	6,2	36	5,5						✓		
RS/08	50x18x1,3	2,0	48	11								✓
RS/008	50x25x1,3	3,0	48	8	-	-	-	-	-	-	-	✓
♦ RSC/08	60x30x1,7	6,2	36	5,5								✓

15% surcharge for unpalletised goods

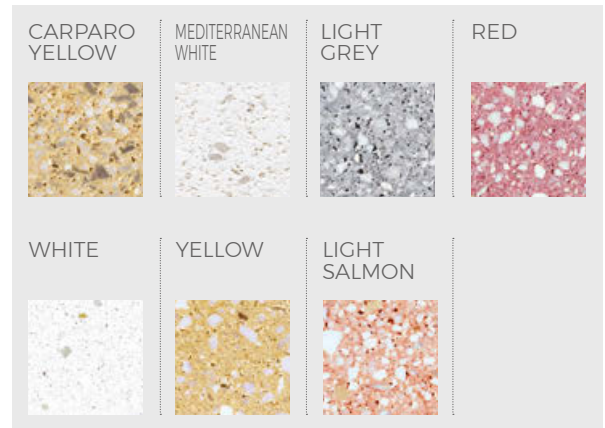

BUSH-HAMMERED WALL COATING® and water resistant

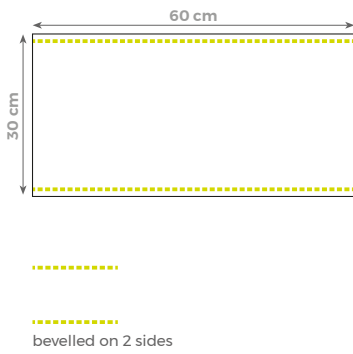

ART.	MEA Cm	weight Kg	PALLET		available colours						
			Mq ^{Pall}	Pcs ^{Mq}	YELLOW	MEDITERR. WHITE	LIGHT GREY	RED	WHITE	YELLOW	LIGHT SALMON
RSGB/01	60x30x1,7	6,2	36	5,5	✓	-	-	-	-	-	-
RSGB/02	60x30x1,7	6,2	36	5,5	-	✓	-	-	-	-	-
RSGB/04	60x30x1,7	6,2	36	5,5	-	-	✓	-	-	-	-
RSGB/05	60x30x1,7	6,2	36	5,5	-	-	-	/	-	-	-
RSGB/06	60x30x1,7	6,2	36	5,5	-	-	-	-	✓	-	-
RSGB/07	60x30x1,7	6,2	36	5,5	-	-	-	-	-	✓	-
RSGB/08	60x30x1,7	6,2	36	5,5	-	-	-	-	-	-	✓

15% surcharge for unpalletised goods

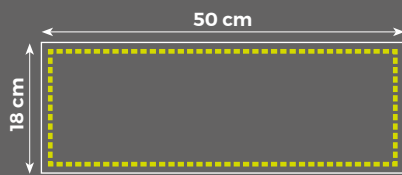

chamfering on 4 sides

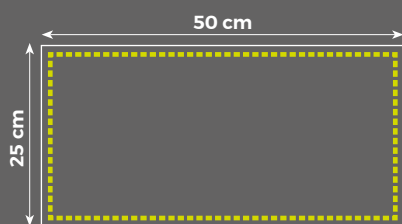

chamfering on 4 sides

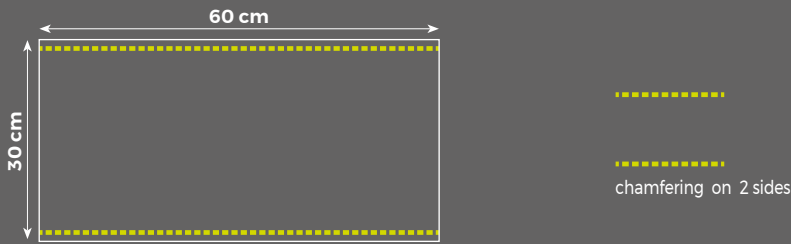

BIOCARPARO WALL COATINGS

ART.	MEA	PALLET		available colours
	Cm	Mq. Pall	Pcs Mq	
RB56/18	50x18x1,3	48	11	√
RB56/25	50x25x1,3	54	8	√
RB56/30	60x30x1,8	36	5,5	√



BIOCARPARO EXTERNAL FRAME

ART.	MEA	PALLET		available colours
	Cm	ML	Pcs	
TB/01	50x4,5x6	200	400	√



1 METER BASEBOARD



MADE IN ITALY

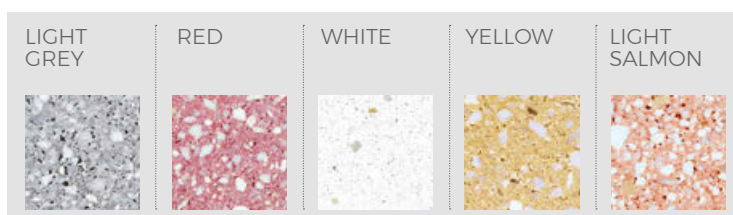
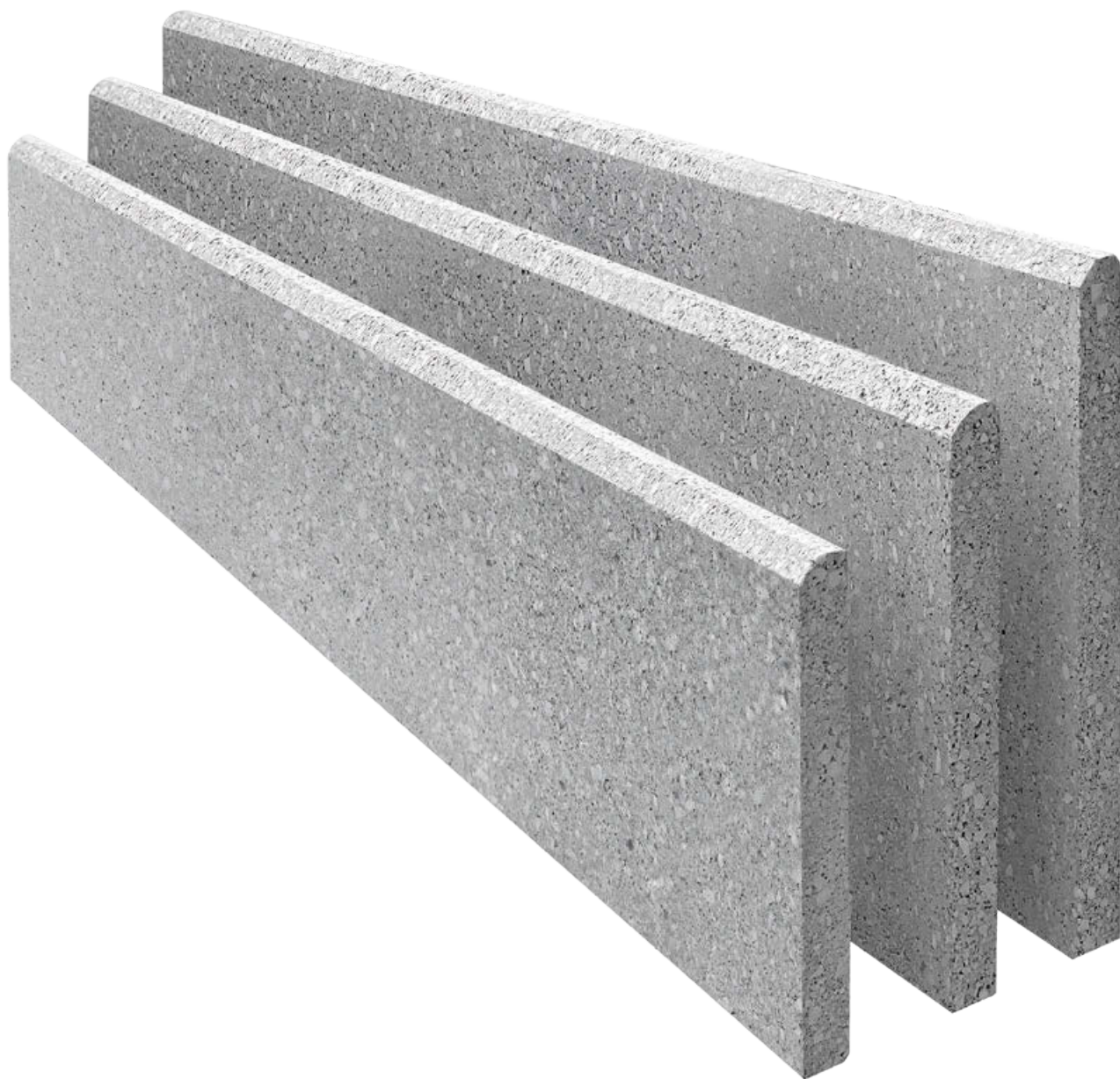

EXTERNAL 1METER BASEBOARD® supersmoothed and water resistant

ART.	INT. MEA Cm	Weight Kg	Pallet Pcs	available colours				
				LIGHT GREY	RED	WHITE	YELLOW	LIGHT SALMON
BT/M/01	100x12x1,7	4,1	60	✓	✓	✓	✓	✓
BT/M/02	100x15x1,7	5,3	60	✓	✓	✓	✓	✓
BT/M/03	100x18,5x1,7	6,7	60	✓	✓	✓	✓	✓

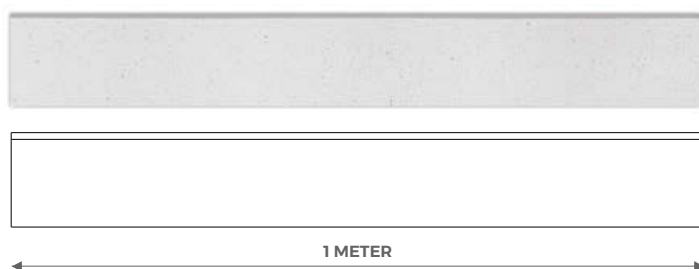

BINDING 6 PIECES





MAGNIFICA* | Modular Fence in cement smoothed coloured and water resistant

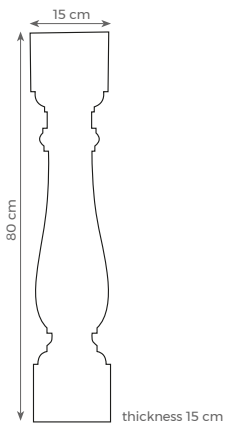

ART.	MEA Cm	Weight Kg	Pallet ML Ped	available colours				
				LIGHT GREY	RED	WHITE	YELLOW	LIGHT SALMON
RZ/01	15x15xh80	23,0	4 49	 ✓	 ✓	 ✓	 ✓	 ✓

* lathe processing

DUCALE | Modular Fence in cement smoothed coloured and water resistant

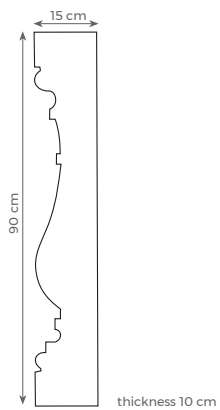

ART.	MEA Cm	Weight Kg	Pallet ML Ped	available colours				
				LIGHT GREY	RED	WHITE	YELLOW	LIGHT SALMON
RZ/02	15x10xh90	21,0	5 60	 ✓	 ✓	 ✓	 ✓	 ✓

MAGNIFICA



DUCALE



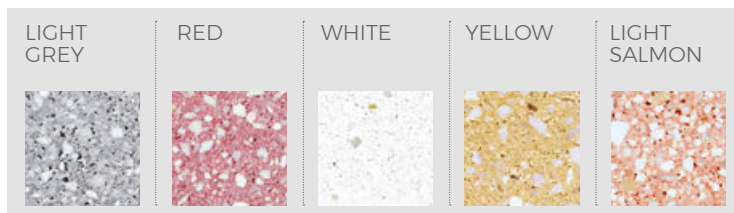

FENCES

SOLARE | Modular Fence in cement smoothed coloured and water resistant

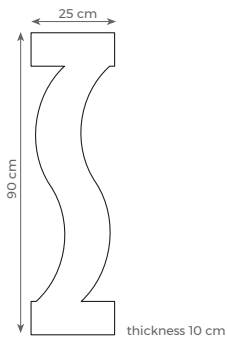

ART.	MEA	Weight per pcs		pcs	available colours				
		Cm	Kg		ML	Ped	LIGHT GREY	RED	WHITE
RZ/03	25x10xh90	34,0	4	40					
					✓	✓	✓	✓	✓

MEDITERRANEA | Modular Fence in cement smoothed coloured and water resistant

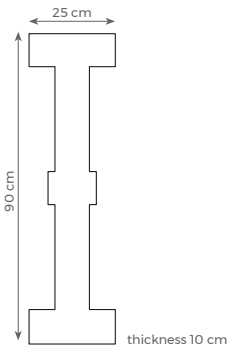

ART.	MEA	Weight per pcs		pcs	available colours				
		Cm	Kg		ML	Ped	LIGHT GREY	RED	WHITE
RZ/04	25x10xh90	29,0	4	40					
					✓	✓	✓	✓	✓

MAESTRALE | Modular Fence in cement smoothed coloured and water resistant

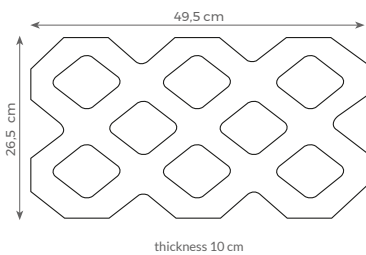

ART.	MEA	Weight per pcs		pcs	available colours				
		Cm	Kg		Mq	Ped	LIGHT GREY	RED	WHITE
RZ/05	50x10xh26	15,0	8	80					
					✓	✓	✓	✓	✓

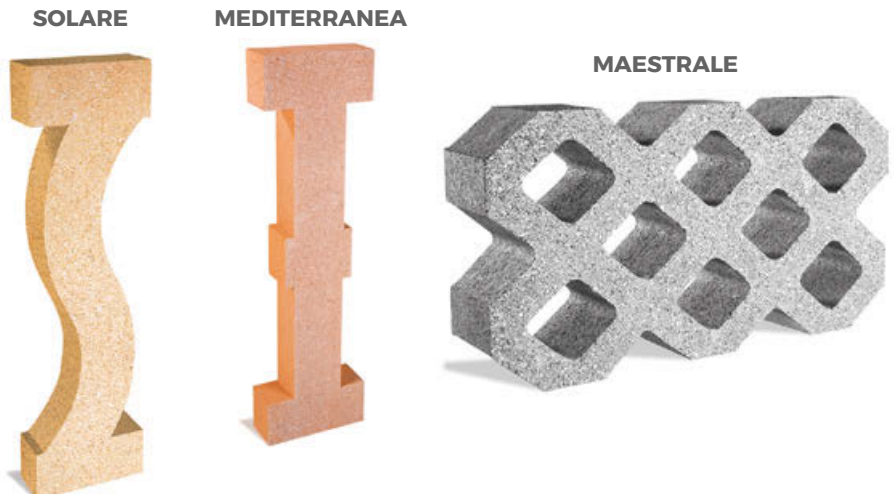

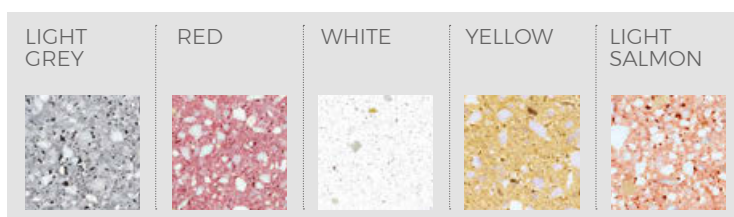

FENCES ACCESSORIES

COATING FOR FENCES in cement smoothed coloured and water resistant

2 pieces per ML



ART.	MEA	Weight per pcs		pcs	available colours				
		Cm	Kg		ML	Pcs	LIGHT GREY	RED	WHITE
RZ/CO/01	50x15xh6,5	14,0	75	150					
RZ/CO/02	50x17xh6,5	17,0	60	120					

HEADBOARD FOR FENCES COATING in cement smoothed coloured and water resistant



ART.	M MEA IS.	Weight per pcs		PALLET	available colours				
		Cm	Kg		Pcs	LIGHT GREY	RED	WHITE	YELLOW
RZ/CT/01	25x15xh6,5	5,0	60						
RZ/CT/02	25x17xh6,5	6,0	60						

BASE CAP in cement smoothed coloured and water resistant



ART.	MEA	Weight per pcs		PALLET	available colours				
		Cm	Kg		Pcs	LIGHT GREY	RED	WHITE	YELLOW
RZ/BS/01	30x30xh6,5	11,0	60						

PYRAMID CAPITAL in cement smoothed coloured and water resistant

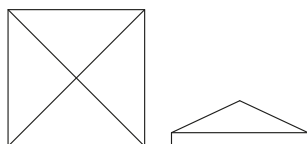

ART.	MEA	Weight per pcs		PALLET	available colours				
		Cm	Kg		Pcs	LIGHT GREY	RED	WHITE	YELLOW
RZ/PR/01	23x23xh10	5,0	60						

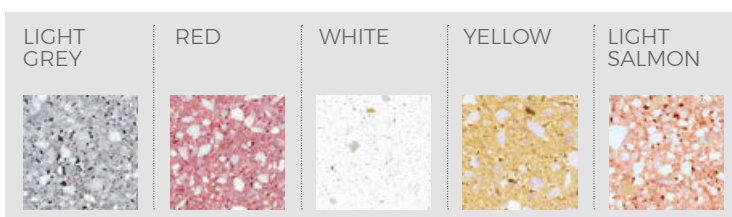

FENCES

ACCESSORIES

CLASSIC PILLAR WITH CHAMFERING in cement coloured and water resistant

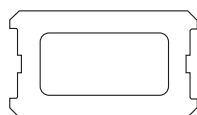

ART.	MEA. Cm	Weight per pcs Kg	PALLET Pz	available colours					
				LIGHT GREY	RED	WHITE	YELLOW	LIGHT SALMON	
RZ/PC/01	30x17xh30 incastro	11/3,5	17,0	72					
RZ/PC/02	30x17xh20 incastro	11/3,5	11,5	72	✓	✓	✓	✓	✓

CLASSIC CORNER PILLAR WITH CHAMFERING in cement coloured and water resistant

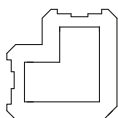

ART.	MEA. Cm	Weight per pcs Kg	PALLET Pz	available colours				
				LIGHT GREY	RED	WHITE	YELLOW	LIGHT SALMON
RZ/PC/A/01	30x30x17xh30/3,5	22,5	27					
RZ/PC/A/02	30x30x17xh20/3,5	15,0	27	✓	✓	✓	✓	✓

CLASSIC HEADBOARD PILLAR WITH CHAMFERING in cement coloured and water resistant

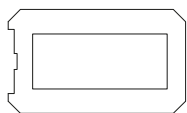

ART.	MEA. Cm	Weight per pcs Kg	PEDANA Pz	available colours				
				LIGHT GREY	RED	WHITE	YELLOW	LIGHT SALMON
RZ/PC/T/01	29x17xh30/3,5	17,0	36					
RZ/PC/T/02	29x17xh20/3,5	11,5	36	✓	✓	✓	✓	✓

SQUARE PILLAR in cement NATURAL coloured and water resistant

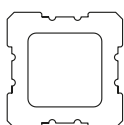

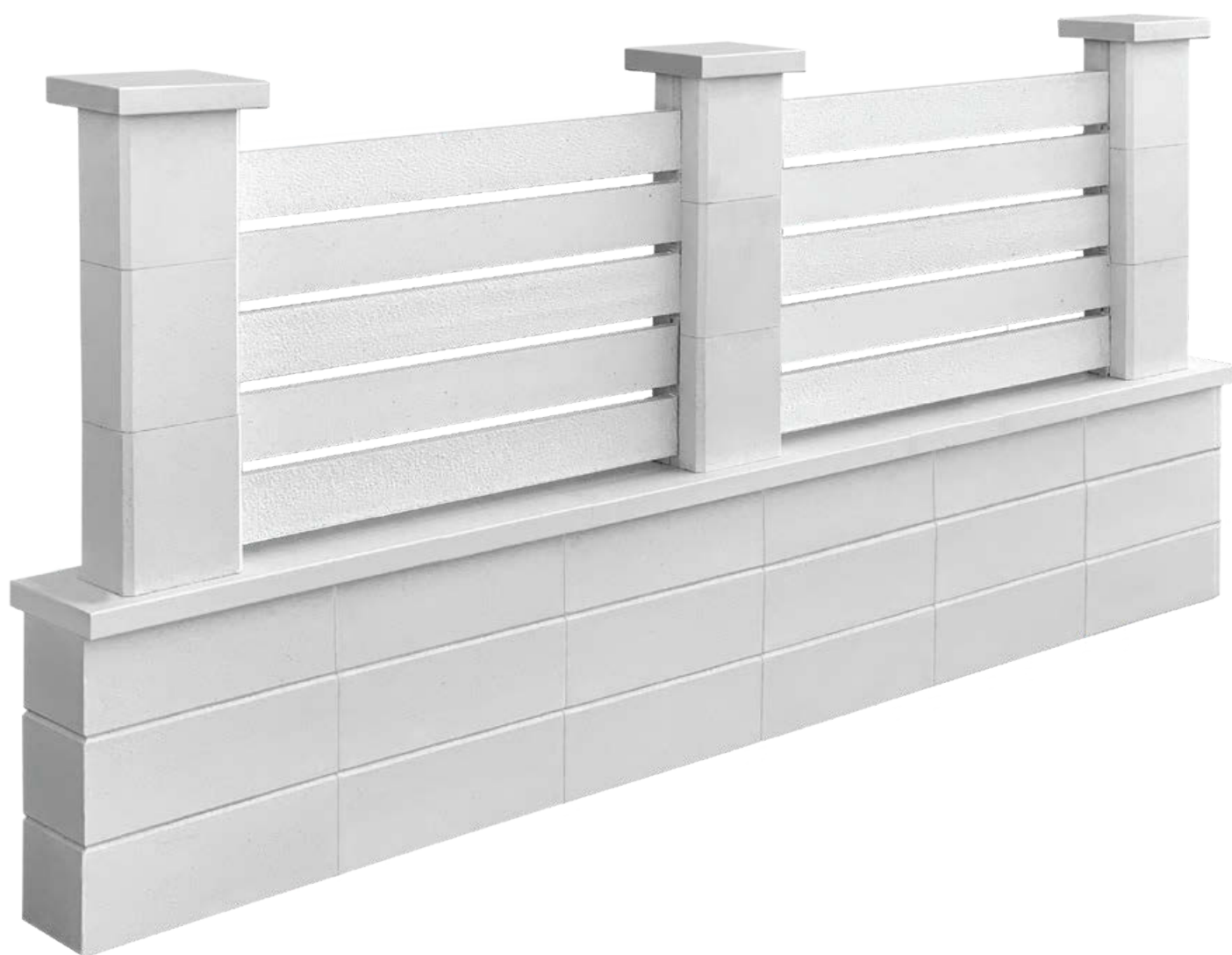

ART.	MEA. Cm	Weight per pcs Kg	PEDANA Pz	available colours				
				LIGHT GREY	RED	WHITE	YELLOW	LIGHT SALMON
RZ/PQ/01	25x25xh20	12,0	64					
				✓	✓	✓	✓	✓



EXTERNAL 1 METER LONG SLAB HORIZON smoothed / bushhammered and water resistant

Slab price inclusive of 2 spacers

ART.	MEA. Cm	Weight per pcs Kg	PALLET Pcs	available colours		
				LIGHT GREY	WHITE	YELLOW
HRZ/L	121,5x13x3,5	8,4	112	 ✓	 ✓	 ✓







SPACER FOR HORIZON FENCE

Price spacers per request more than 2 pieces per slab

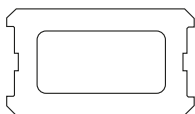
HRZ/D	3,5x1,5xh1,5			✓	✓	✓
-------	--------------	--	--	---	---	---



NATURAL HORIZON PILLAR in cement coloured and water resistant



ART.	MEA. Cm	Weight per pcs Kg	PALLET Pcs	available colours			
				LIGHT GREY	WHITE	YELLOW	
HRZ/P/I/01	30x17xh30 incastro	11/3,5	17,0	72	 ✓	 ✓	 ✓
HRZ/P/I/02	30x17xh20 incastro	11/3,5	11,5	72	✓	✓	✓

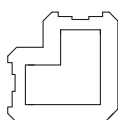

NATURAL CORNER HORIZON PILLAR in cement coloured and water resistant



ART.	MEA. Cm	Weight per pcs Kg	PALLET Pcs	available colours		
				LIGHT GREY	WHITE	YELLOW
HRZ/P/A/01	30x30x17xh30/3,5	22,5	27	 ✓	 ✓	 ✓
HRZ/P/A/02	30x30x17xh20/3,5	15,0	27	✓	✓	✓

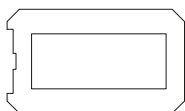

HORIZON PILLAR HEAD in cement coloured and water resistant



ART.	MEA. Cm	Weight per pcs Kg	PALLET Pcs	available colours		
				LIGHT GREY	WHITE	YELLOW
HRZ/P/T/01	29x17xh30/3,5	17,0	36	 ✓	 ✓	 ✓
HRZ/P/T/02	29x17xh20/3,5	11,5	36	✓	✓	✓

HORIZON CAP in cement coloured and water resistant



ART.	MEA. Cm	Weight per pcs Kg	PALLET Pcs	available colours		
				LIGHT GREY	WHITE	YELLOW
HRZ/CP	31x16,5x5	5,5	60	 ✓	 ✓	 ✓



BLOCK21 double face honed rectified and waterproof

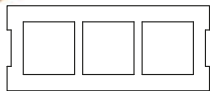
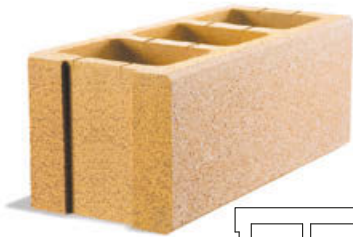

ART.	MEA.	Weight per pcs		PALLET		available colours								
		Cm	Kg	Pcs ^{Mq}	Mq ^{Pal}	LIGHT GREY	RED	WHITE	YELLOW	LIGHT SALMON				
BL/01	50x21xh20	20,0	10	6						✓	✓	✓	✓	✓

BLOCK21 HEADER in colored and water/repellent cement

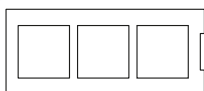

ART.	MEA.	Weight per pcs		PALLET		available colours								
		Cm	Kg	Pcs	LIGHT GREY	RED	WHITE	YELLOW	LIGHT SALMON					
BL/T/01	49x21xh20	20,0	60							✓	✓	✓	✓	✓

BLOCK21 COLUMN in colored and water/repellent cement

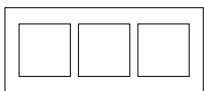

ART.	MEA.	Weight per pcs		PALLET		available colours								
		Cm	Kg	Pcs	LIGHT GREY	RED	WHITE	YELLOW	LIGHT SALMON					
BL/C/01	48x21xh20	20,0	60							✓	✓	✓	✓	✓

BLOCK21 COLUMN CAPITAL* ELITE in colored and water/repellent cement

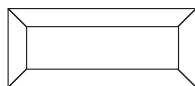

ART.	MEA.	Weight per pcs		PALLET		available colours								
		Cm	Kg	Pcs	LIGHT GREY	RED	WHITE	YELLOW	LIGHT SALMON					
CP/BL/EL	51x22x5,5	22,9	60							✓	✓	✓	✓	✓

* column capital with joint system

BLOCK21 COLUMN CAPITAL* EVO in colored and water/repellent cement



ART.	MEA.	Weight per pcs		PALLET		available colours								
		Cm	Kg	Pcs	LIGHT GREY	RED	WHITE	YELLOW	LIGHT SALMON					
CP/BL/EV	51x22x5	22,9	60							✓	✓	✓	✓	✓

* column capital with joint system





NATURAL SIDEWALK

NATURAL SIDEWALK in colored and water/repellent cement

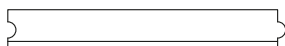
2 pcs per ML

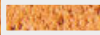
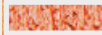

ART.	MEA. Cm	Weight per pcs Kg	PALLET		available colours				
					ML	Pcs	GREY	RED	WHITE
									
CON/01	50x7,5xh19	14,0	52	104	✓	-	-	-	-
CON/02	50x7,5xh19	14,0	52	104	-	✓	-	-	-
CON/03	50x7,5xh19	14,0	52	104	-	-	✓	-	-
CON/04	50x7,5xh19	14,0	52	104	-	-	-	✓	-
CON/05	50x7,5xh19	14,0	52	104	-	-	-	-	✓

SMOOTH EFFECT

The wall coatings slabs®, seasoned and properly cut, stand out for the surface smoothed and solid that put in evidence the calcareous aggregates of the mixture.



LIGHT GREY



DARK GREY

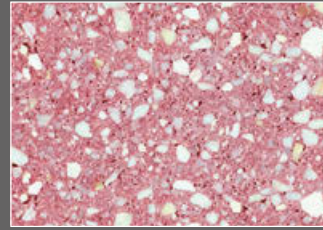

RED



WHITE

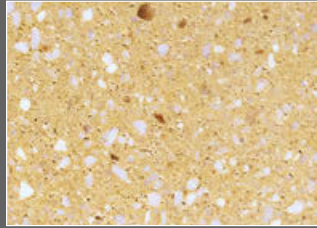

YELLOW

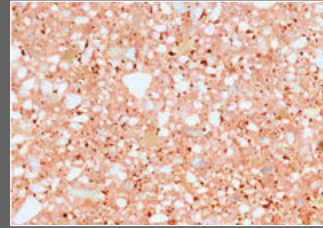

LIGHT SALMON



MEDITERRANEAN WHITE

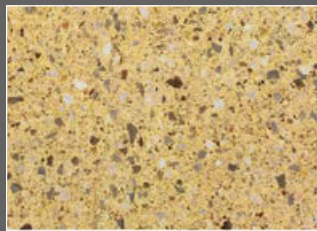

CARPARO YELLOW

NATURAL EFFECT

During molding, the mixtures properly seasoned, become uneven and grainy.



WHITE



YELLOW

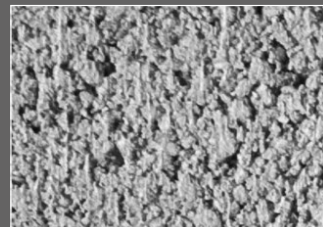

GREY



RED



SALMON

The products are made with natural stones and aggregates, our Company can guarantee their constancy and not their equality.

LAYING AND GENERAL MAINTENANCE WARNINGS.

In order to guarantee a long lasting life to the wall coping we advise to carry out, after the laying, a protective treatment on all the surface with a water resistant and perspiring product, which has to be transparent. Please, clean the surface before making it and spread it evenly on all sides. Our products, due to the fact that are produced using natural aggregates, carved, from local stones, could have different shades of colours.

GENERAL LAYING INSTRUCTIONS

Preparation of the laying surface: 1) clean the wall with water after having removed any kind of impurity; 2) let it dry; 3) remove carefully residual dust; 4) make sure there are no difference in level on the upper part of the wall.

Laying: 1) do not use classic cement mortar, in order to avoid the wall coping coming off over time; 2) use specific glues, following the manufacturer instructions; 3) keep between one wall coping and the other one a distance of about 1,5/2 mm. and use high quality wall putty following the manufacturer instructions; 4) do not use classic cement mortar as wall putty; make sure there are not less than 5 mm of air between plaster and drip; 5) Putty close to the hole around the fence post, avoiding placing more than 5 mm of putty around the fence post. **Safety:** Adopt the safety devices and regulations in force.



IMER[®]
INDUSTRY FOR BUILDING PRODUCTS

Maglie (Le) √ ITALY
Zona Industriale
Tel. / Fax +39 0836 423507
Tel. +39 0836 315814

imeritalia.it
commerciale@imeritalia.it

