BATHROOM EXPERIENCE

2026

I dettagli non sono dettagli,
fanno il design.

Details are not details,
they make the design.

Charles Eames



MADE IN ITALY
SINCE 1965



AZIENDA

Nata nel 1965, Fiore è un nome ben noto e stimato da uomini d'affari del settore, nonché dai consumatori stessi, in Italia e in tutto il mondo.

Il motivo di questa rapida crescita e dei successi commerciali sono dovuti sia alla competenza di coloro che lavorano in azienda che dai grandi investimenti effettuati da Fiore Rubinetterie nel corso degli anni.

COMPANY

Born in 1965, today FIORE is a well-known name, esteemed by businessmen of the same sector as well as by the consumers themselves, in Italy and all over the world. This rapid growth and the subsequent commercial successes are due to the competence of our staff as well as to the large investments made by Fiore Rubinetterie over the years.



GUARDA IL VIDEO
WATCH THE VIDEO



QUALITÀ & SERVIZIO

La qualità dei prodotti e la massima cura alle richieste dei clienti, nonché la capacità di soddisfare le loro esigenze nel tempo più breve possibile, sono i punti focali della filosofia aziendale di Fiore e la ragione per i suoi continui successi.

QUALITY & SERVICE

Product quality, attention to customers' needs and the ability to meet their requirements in the shortest time possible are the focal points of Fiore philosophy and the reason for our continuous success.



GUARDA IL VIDEO
WATCH THE VIDEO



PROGETTO

La produzione Fiore inizia dallo studio progettuale seguendo le richieste dei clienti, le tendenze del mercato e il desiderio di innovazione attraverso la competenza e la ricerca durante la fase progettuale e creativa. Il Centro Ricerca e Design Fiore è in continuo movimento fra sperimentazione e tecnologia, in totale apertura verso ogni novità di settore per quanto riguarda sistemi di lavorazione, finiture, ottimizzazione delle risorse e tendenze di Design.

PROJECT

Fiore production starts from the study of the design according to customers' requirements, market trends and our strong desire for innovation. Fiore Research and Design Center is constantly moving between experimentation and technology following the latest innovations regarding manufacturing systems, product optimization and design trends.



GUARDA IL VIDEO
WATCH THE VIDEO



SOSTENI BILITÀ

Ogni rifiuto al suo posto. Il maggiore spreco dei rifiuti riguarda gli errori che possiamo fare con la raccolta differenziata. Significa aumentare l'inquinamento e la sporcizia (compresi gli oggetti che finiscono nelle discariche) e azzerare le possibilità del riciclo. In genere, trovate le regole su come separare i materiali direttamente sui casonetti adibiti alla raccolta ma non sempre è facile capire se quel determinato rifiuto deve essere riciclato oppure buttato via perché non recuperabile. Per dare il nostro contributo abbiamo applicato alle scatole dei nostri prodotti un QR code che rimanda alle indicazioni necessarie per smaltire correttamente i vari materiali.

SUSTAI NAB

Putting every waste in its place. The biggest rubbish waste concerns the mistakes we risk to make when recycling. This means increasing pollution and litter (including items that end up in landfills) and zeroing the chances of recycling. You can usually find the rules on how to separate materials directly on the collection bins. However it is not always easy to understand whether that particular waste should be recycled or thrown away because it cannot be recovered. To make our own contribution, on all our product boxes we put a QR code that links to the necessary instructions on how to dispose of the various materials correctly.



SCOPRI DI PIÙ
FIND OUT MORE



DETAILS



MADE IN ITALY

RESEARCH



QUALITY

DESIGN

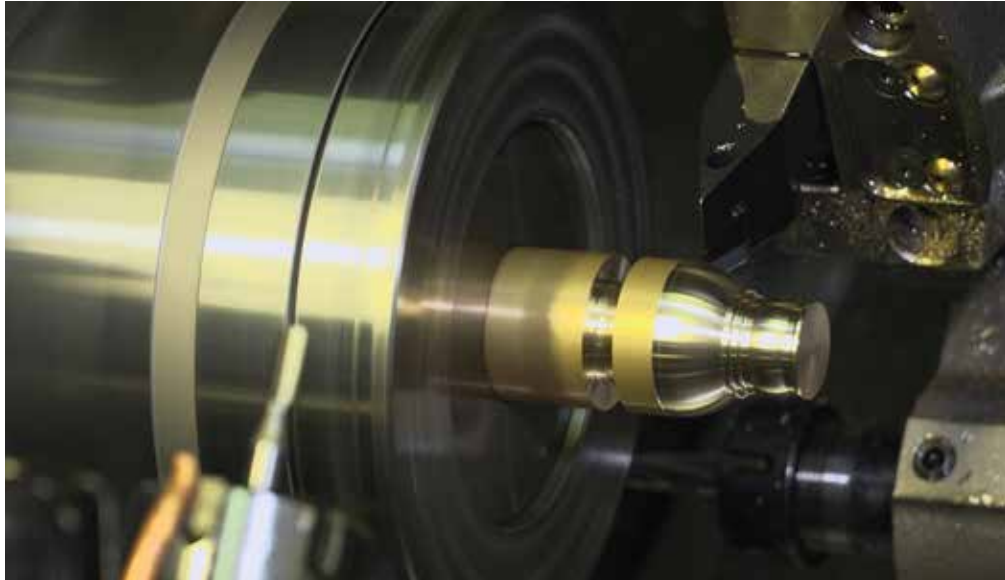

TRENDS

PRODUCT



PROJECT

CONTRACT _ PROJECT

BURJ DAMAC WATERFRONT
DOHA, QATAR



THE ADDRESS HOTEL
DUBAI, UAE



GUMI
SEOUL, KOREA



RAMADA
LAHORE, PAKISTAN



GRAND TUNIS HOTEL
TUNIS, TUNISIA



MAYA 5 / MAYA 7
DUBAI, UAE



AL DUJA TOWER
DUBAI, UAE



SHANGRI-LA'S HOTEL
SABAH, MALAYSIA



IGO APARTMENTS
DUBAI, UAE



HOTEL SIR E.K. SAVIGNY
BERLIN, GERMANY



LUX BELLE MARE
MAURITIUS



WYNDHAM EXELSIOR
BERLIN, GERMANY



T-SQUARE
LAHORE, PAKISTAN



ORMA BY PEDRABLES
SANTO DOMINGO



OUTRIGGER BEACH RESORT
MAURITIUS



KALDERIMI COUNTRY HOUSE
MAGNISIA, GREECE



MAG 5
DUBAI, UAE



THE SPRING APARTMENTS
LAHORE, PAKISTAN



TRIP BY WYNDHAM
DUSSELDORF, GERMANY



DOMUS HOTEL
BERLIN, GERMANY



SAN MARCO HOTEL
MYKONOS, GREECE



RESIDENCE LES TULIPES
Sfax, TUNISIA



AZIZAH HOTEL
MECCA, SAUDI ARABIA



MALAHINI KUDA BANDOS
MALDIVE



HIGH Q TOWER
LAHORE, PAKISTAN



BOUTIQUE HOTEL
PRAGA, CZECH REPUBLIC



HOTEL CONDOTTI
ROME, ITALY



SUNLIFE RESORT
MAURITIUS



HOTEL ROTELLE
TORRITA DI SIENA, ITALY



TERRADIMARE RESORT&SPA
SAN TEODORO, ITALY



AL HABTOOR PALACE
DUBAI, UAE



NGORONGORO SERENA SAFARI
TANZANIA



RADISSON BLU RESORT
SHARJAH, UAE



CONTRACT _ PROJECT

SCOPRI QUI TUTTI LE
REFERENZE

DISCOVER ALL THE
REFERENCES



Primavera

COLLEZIONE

Dall'incontro tra le tendenze dell'alta moda e l'interior design nasce la collezione Primavera, un nuovo concept che, attraverso il colore, permette di creare il proprio spazio a misura della propria personalità.

Troviamo i colori pastello, per chi ama gli spazi caratterizzati prevalentemente da tonalità tenui, nei quali rilassarsi e rigenerarsi.

Per le personalità più decise ed estrose proponiamo colori accesi, dal giallo, al rosso, al verde... Perfetti per persone a cui piace osare e che vogliono rispecchiare il proprio essere nella casa.

Haute couture trends meet interior designing giving birth to Primavera collection, a new concept that uses colours to shape the environment to fit one's own personality.

Pastel colours are intended for those who love spaces mainly characterised by muted tones, where one can relax and rejuvenate.

For strong and outgoing personalities we propose bright colours like yellow, red, green and many more. Perfect for people who like to dare and who want their home to be the reflection of their being.

Primavera

COLLEZIONE



BL
BLU NOTTE



TU
TURCHESE



GL
GLICINE



CI
CIPRIA



TO
TORTORA



BR
BORGOGNA



OA
OCRA



SM
SMERALDO



AM
ACQUAMARINA



LI
LIME



AD
ARDESIA



NK
NICKEL



TS
TERRA DI SIENA



PP
PORPORA



AO
ARANCIONE



CB
COBALTO



VG
VERDE GIADA



CE
CELESTE



PR
PERLA ROSA



RA
ROSA ANTICO



OS
ORO SCURO



OC
ORO CHIARO



CH
CHAMPAGNE



AG
ARGENTO



SS
SATINATO

Matt

COLORS

Met

COLORS

FINITURE _ FINISHINGS

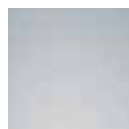

CR
CROMO
CHROME

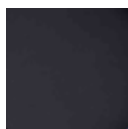

NN
NERO OPACO
MATT BLACK

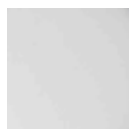

BB
BIANCO OPACO
MATT WHITE



OR
ORO ROSA
ROSE GOLD



ZZ
VECCHIO BRONZO
OLD BRONZE



RR
VECCHIO RAME
OLD COPPER



OO
ORO
GOLD



AA
ACCIAIO
STEEL



GS
GRANITO SABBIA
GRANITE SAND



GN
GRANITO NERO
GRANITE BLACK

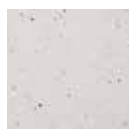

C1
CARON 1



C3
CARON 3



TC
TERRA DI FRANCIA



CC
CAPPUCCINO

Hedra
24

Easy Wellness
30

Xenon Charme
38

Xenon Slim
50

Kube
62

Dark
74

Xenon Steel
86

Kera
92

Katana
98

Xenon
106

Kalos
112

Kevon
118

Kyro
128

Accessori bagno
134

Jafar
140

Margot
146

Spazio doccia / Shower space
152

Accessori / Accessories
160

Cucina / Kitchen
164

Pensata per integrarsi con armonia in ambienti bagno contemporanei, Hedra unisce estetica e funzionalità, offrendo un'esperienza d'uso piacevole e intuitiva.

Ogni elemento della collezione è caratterizzato da curve fluide e profili levigati, che trasmettono una sensazione di leggerezza visiva e tattilità sofisticata.

Designed to integrate harmoniously into contemporary bathroom environments, Hedra combines aesthetics and functionality, offering a pleasant and intuitive user experience.

Each element in the collection features smooth curves and refined profiles, conveying a sense of visual lightness and sophisticated tactility.



HEDRA

^
130NN3316
Miscelatore lavabo medio.
Medium basin mixer.



HEDRA — CONTEMPORARY

^
130NN3316
Miscelatore lavabo medio.
Medium basin mixer.



^
130NN3318
Miscelatore lavabo alto.
High basin mixer.

PRODUCT SELECTION



130CR3313
Miscelatore lavabo.
One hole basin mixer.



130CR3316
Miscelatore lavabo medio.
One hole medium basin mixer.



130CR3318
Miscelatore lavabo alto.
One hole tall basin mixer.



130CR3355
Bordo vasca 4 fori.
4-hole bath mixer.



130CR3361
Miscelatore doccia esterno
senza duplex.
*External shower mixer
without shower set.*



140CR4470
Miscelatore doccia esterno,
attacco superiore.
*External shower mixer, upper
connection.*



130CR3331
Miscelatore bidet.
One hole bidet mixer.



130CR3340
Miscelatore lavabo 3 fori.
3-hole basin mixer.



130CR3345
Batteria lavabo 3 fori.
3-hole basin mixer.



130CR9571
Miscelatore doccia incasso 1 via.
1-way built-in shower mixer.
Ø35



130CR9574
Miscelatore doccia incasso con
deviatore ceramico 2 vie.
*2-way built-in shower mixer with
ceramic diverter.*
Ø35



130CR9573
Miscelatore doccia incasso con
deviatore ceramico 3 vie.
*3-way built-in shower mixer with
ceramic diverter.*
Ø35



130CR9505
Miscelatore lavabo a muro.
Wall basin mixer.
Ø35



130CR9534
Miscelatore lavabo a muro.
Wall basin mixer.
Ø35



130CR3350
Miscelatore vasca con duplex.
Bath mixer with shower set.

EASY COVER

BENVENUTI NELL'ERA DELL'IDRAULICA SENZA LIMITI!

WELCOME TO THE AGE OF PLUMBING WITH NO LIMITS!

Il nostro nuovo progetto sui corpi incasso è un'ottima soluzione per chi desidera combinare funzionalità, estetica e flessibilità. Un nuovo modo di vedere e di vivere la progettazione dell'ambiente bagno per quanto riguarda miscelatori da incasso lavabo e doccia, che offre la libertà di decidere senza limiti.

La possibilità di installazione solo del corpo incasso facilita sia il lavoro dell'idraulico, il quale può procedere senza le parti esterne, sia il cliente che ha tutto il tempo di decidere comodamente design e finitura per rispettare lo stile del bagno.

Our new design on concealed bodies is an excellent solution for those who wish to combine functionality, aesthetics and flexibility. A new way of looking at and experiencing bathroom design with regard to concealed basin and shower mixers, which offers the freedom to decide without limits.

The possibility of installing only the built-in body facilitates both the work of the plumber, who can proceed without the external parts, as well as the customer who has plenty of time to comfortably decide on the design and finish to match the style of the bathroom.

I VANTAGGI

- Estetica Pulita: le parti interne sono nascoste, lasciando una superficie esterna minima e ordinata.
- Manutenzione semplice: le parti esterne intercambiabili consentono una manutenzione e un aggiornamento più semplici, senza dover smontare l'intera unità.
- Flessibilità di design: puoi cambiare l'aspetto della tua doccia con facilità, aggiornando solo le parti esterne per adattarle a nuove tendenze o cambiamenti di arredamento.

THE ADVANTAGES

- Clean aesthetics: internal parts are hidden, leaving a minimal, neat external surface.
- Simple maintenance: interchangeable external parts allow easier changes and maintenance, without having to dismantle the entire unit.
- Flexible design: you can easily change your shower look, replacing only the external parts to suit new trends or changes in décor.

NUOVO DOCCIA INCASSO UNIVERSALE

NEW UNIVERSAL BUILT-IN BODY

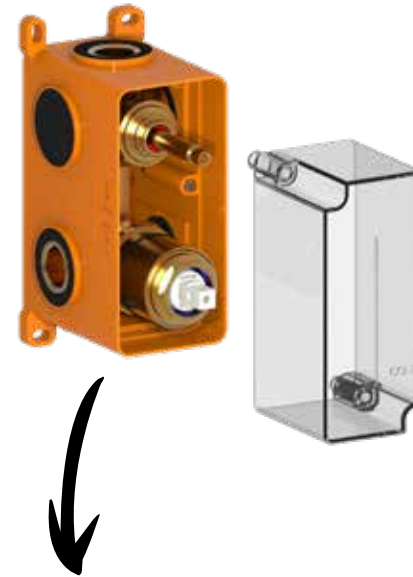

Installa prima solo
il corpo incasso
*Install only the
built-in body
first*

Decidi successivamente
design e finitura delle parti
esterne

*Decide later design and
finish of the external parts*

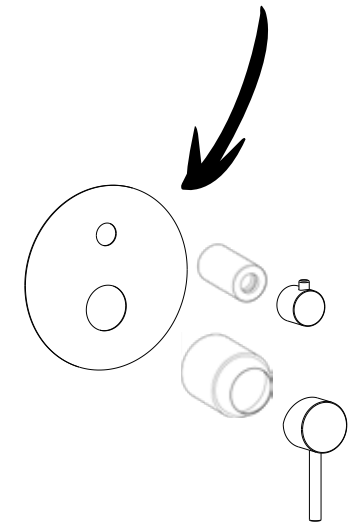

SCAN FOR VIDEO

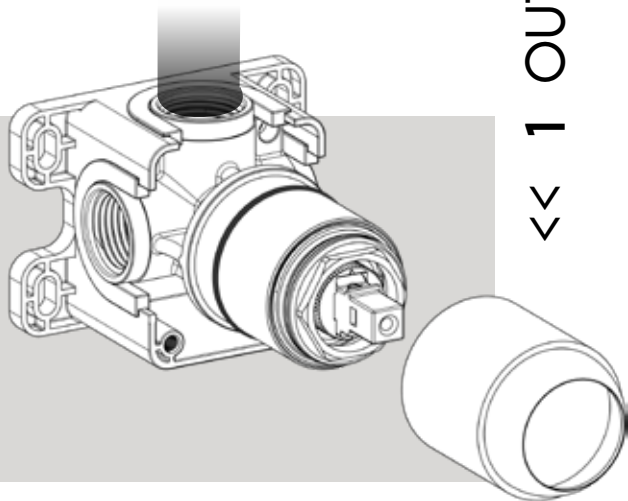

<< 1 OUT

1 USCITA
.....
1 OUTLET

PARTE ESTERNA COMPLETA DI PIASTRA,
LEVA E CAPPUCCIO

EXTERNAL PART COMPLETE WITH PLATE,
LEVER AND CAP

PIASTRA CON BORDO E GUARNIZIONE
PLATE WITH RAISED EDGE AND GASKET

8 mm

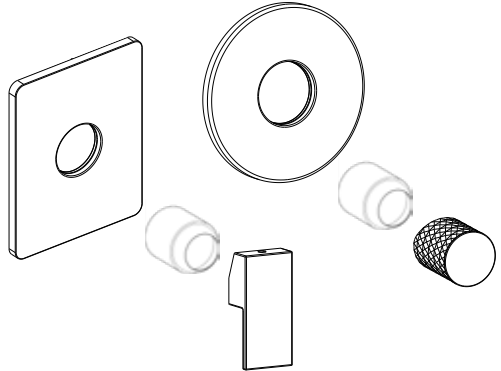

PIASTRA SPESSORE 1 mm
PLATE 1 mm THICK

1 mm

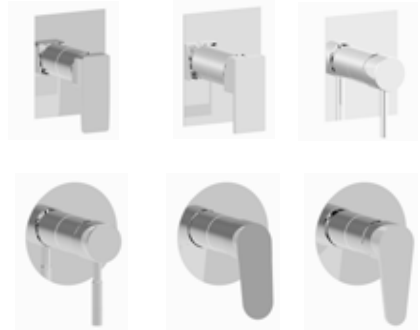
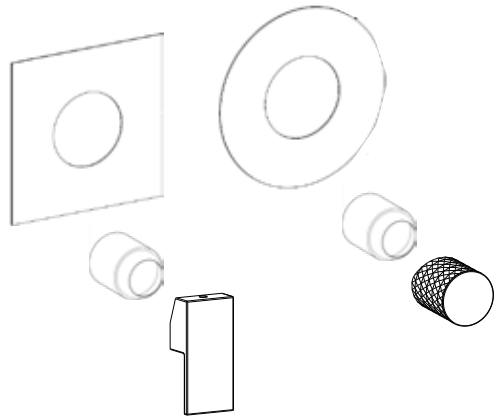

CONFIGURAZIONE DOCCIA 1 USCITA
SHOWER CONFIGURATION 1 OUTLET

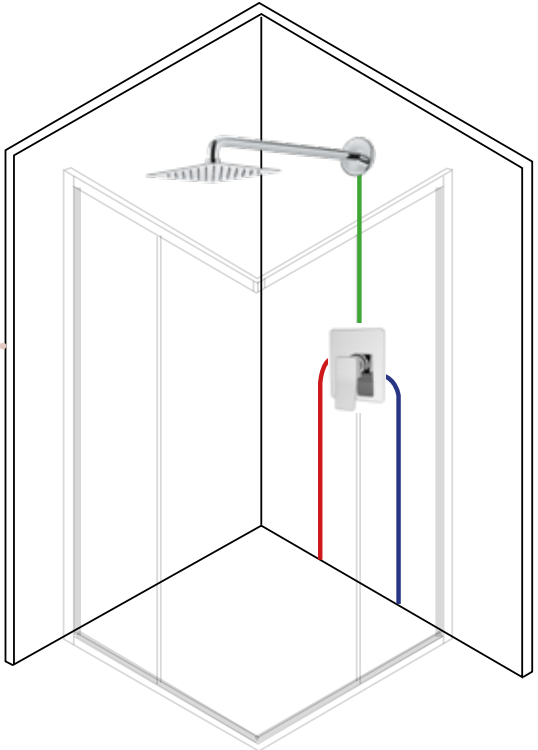

35AC5001
Corpo incasso 1 uscita EASY K-BOX.
EASY K-BOX 1-way built-in body.

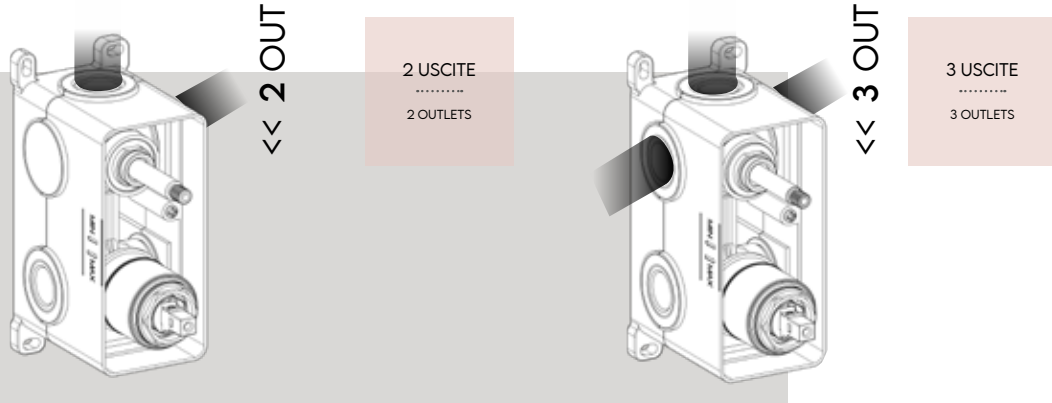

PARTE ESTERNA COMPLETA DI PIASTRA, LEVA, CAPPUCCIO, COPRIDEVIATORE E POMOLO

EXTERNAL PART COMPLETE WITH PLATE, LEVER, CAP, DIVERTER COVER AND KNOB

PIASTRA CON BORDO E GUARNIZIONE
PLATE WITH RAISED EDGE AND GASKET

8 mm

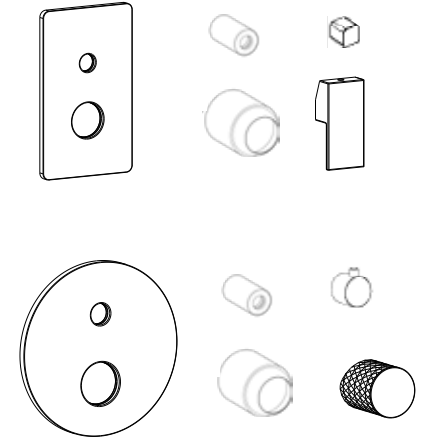

PIASTRA SPESSORE 1 mm
PLATE 1 mm THICK

1 mm

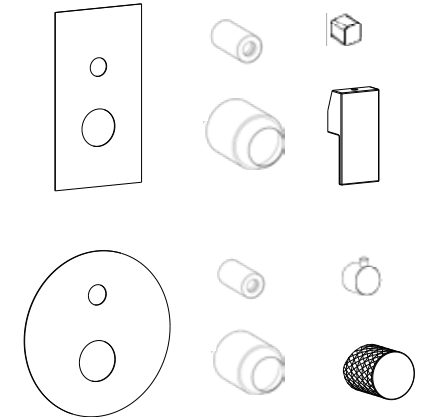

35AC5002
Corpo incasso 2 uscita EASY K-BOX.
EASY K-BOX 2-way built-in body.

CONFIGURAZIONE DOCCIA 2 USCITE
CON DEVIATORE CERAMICO
SHOWER CONFIGURATION 2 OUTLETS
WITH CERAMIC DIVERTER

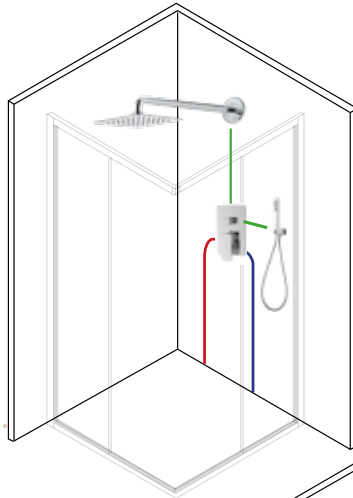

35AC5003
Corpo incasso 3 uscita EASY K-BOX.
EASY K-BOX 3-way built-in body.

CONFIGURAZIONE DOCCIA 3 USCITE
CON DEVIATORE CERAMICO
SHOWER CONFIGURATION 3 OUTLETS
WITH CERAMIC DIVERTER

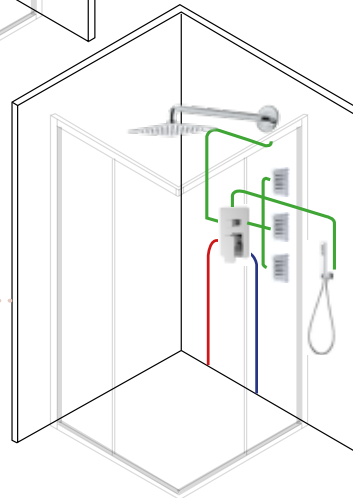

CORPO INCASSO PER LAVABO A MURO
CON PIASTRA INTEGRALE UNICA E PIASTRE SEPARATE

BUILT-IN BODY FOR WALL BASIN MIXER WITH
SINGLE HORIZONTAL PLATE AND SEPARATE PLATES



LAVABO A MURO

WALL BASIN MIXER

35AC5004

Corpo incasso EASY K-BOX per miscelatore lavabo
a muro con piastra integrale unica e piastre separate.

EASY K-BOX built-in body for wall basin mixer with
single plate and separate plates.

PARTI ESTERNE COMPLETE DI PIASTRE, LEVA,
CAPPUCCIO, BOCCA E RACCORDO

EXTERNAL PARTS COMPLETE WITH PLATES,
LEVER, CAP, SPOUT AND CONNECTION

PIASTRA CON BORDO E GUARNIZIONE
PLATE WITH RAISED EDGE AND GASKET

8 mm



PIASTRA SPESSORE 1 mm
PLATE 1 mm THICK

1 mm



CORPI INCASSO TERMOSTATICI

THERMOSTATIC BUILT-IN BODIES

PARTI ESTERNE DISPONIBILI ANCHE NELLE FINITURE DELLA
COLLEZIONE PRIMAVERA

EXTERNAL PARTS ALSO AVAILABLE IN THE FINISHES OF THE
COLLEZIONE PRIMAVERA

35AC6001

Corpo incasso termostatico 1 uscita EASY K-BOX.
EASY K-BOX 1-way thermostatic built-in body.



35AC6002

Corpo incasso termostatico 2 uscite EASY K-BOX.
EASY K-BOX 2-way thermostatic built-in body.



35AC6003

Corpo incasso termostatico 3 uscite EASY K-BOX.
EASY K-BOX 3-way thermostatic built-in body.



TERMOSTATICI

THERMOSTATIC

PIASTRA CON BORDO E GUARNIZIONE
PLATE WITH RAISED EDGE AND GASKET



8 mm

PIASTRA CON BORDO E GUARNIZIONE
PLATE WITH RAISED EDGE AND GASKET



8 mm

PIASTRA CON BORDO E GUARNIZIONE
PLATE WITH RAISED EDGE AND GASKET



8 mm

Un tratto distintivo e finiture eleganti contraddistinguono la nuova serie Xenon Charme.

Una serie da bagno completa dalle linee sinuose e allo stesso tempo minimal arricchita dai dettagli unici della leva dati sia dalla lavorazione sia dalle particolari finiture in PVD. Questo gioco di forme e colori consente un alto livello di personalizzazione da abbinare facilmente a diversi stili di arredo bagno.

Distinctive features and elegant finishes characterise our new Xenon Charme series.

A complete bathroom series with sinuous and at the same time minimal lines enriched by the unique details of the lever given both by the workmanship and by the special PVD finishes. This interplay of shapes and colours allows for a high level of customisation that can be easily combined with different bathroom furnishing styles.



XENON CHARME



441NNGR5250
Miscelatore lavabo alto.
One hole basin mixer, high body.
Leva/Lever Grafite

STYLE
ELEGANCE
CUSTOMIZATION

CHARME



< 441NNA5230
Miscelatore lavabo.
One hole basin mixer.
Leva/Lever Steel

PVD TECHNOLOGY

PHYSICAL VAPOUR DEPOSITION



441NNCN5250 >
Miscelatore lavabo alto.
One hole basin mixer, high body.
Leva/Lever Black chrome



CROMO
CHROME



ACCIAIO
STEEL



GRAFITE
GRAPHITE



CROMO NERO
BLACK CHROME



NERO OPACO
MATT BLACK

Le leve in 5 finiture sono disponibili per tutti i prodotti della serie.
Levers in 5 finishes are available for all products in the series.

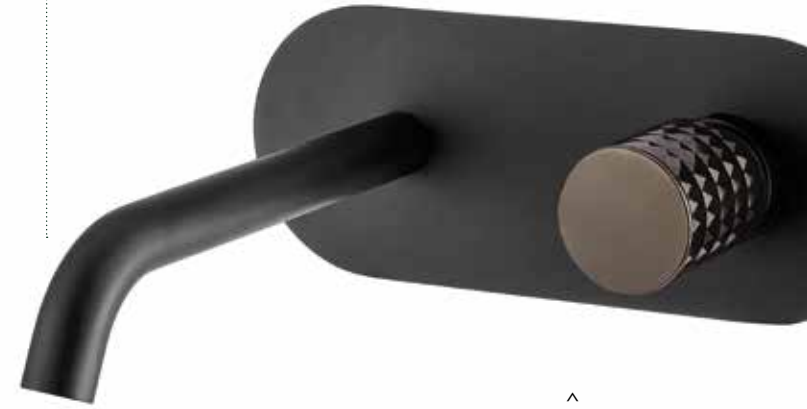

441NNCN9503
Miscelatore lavabo a muro.
Wall basin mixer.
Leva/Lever Black chrome

Ø35





441NNNN7679 >
 Miselatore doccia incasso con
 deviatore ceramico 3 vie.
 3-way built-in shower mixer with
 ceramic diverter.
 Leva/Lever Matt black

Ø35

NNNN nero + leva nero opaco
 NNCR nero + leva cromo
 NNAA nero + leva simil acciaio
 NNCN nero + leva cromo nero
 NNGR nero + leva grafite

NNNN *matt black + matt black lever*
 NNCR *matt black + chrome lever*
 NNAA *matt black + steel lever*
 NNCN *matt black + black chrome lever*
 NNGR *matt black + graphite lever*

CRCR cromo + leva cromo
 CRNN cromo + leva nero opaco
 CRAA cromo + leva simil acciaio
 CRCN cromo + leva cromo nero
 CRGR cromo + leva grafite

CRCR *chrome + chrome lever*
 CRNN *chrome + matt black lever*
 CRAA *chrome + steel lever*
 CRCN *chrome + black chrome lever*
 CRGR *chrome + graphite lever*





441CRCR5230
Miscelatore lavabo.
One hole basin mixer.



441CRCR5240
Miscelatore lavabo medio.
One hole medium basin mixer.



441CRCR5250
Miscelatore lavabo alto.
One hole tall basin mixer.



441NNNN5230
Miscelatore lavabo.
One hole basin mixer.



441NNNN5240
Miscelatore lavabo medio.
One hole medium basin mixer.



441NNNN5250
Miscelatore lavabo alto.
One hole tall basin mixer.



441CRCR5255
Miscelatore bidet.
One hole bidet mixer.



441CRCR9503
Miscelatore lavabo a muro.
Wall basin mixer.
Ø35



441CRCR9523
Miscelatore lavabo a muro.
Wall basin mixer.
Ø35



441NNNN5255
Miscelatore bidet.
One hole bidet mixer.



441NNNN9503
Miscelatore lavabo a muro.
Wall basin mixer.
Ø35



441NNNN9523
Miscelatore lavabo a muro.
Wall basin mixer.
Ø35



441CRCR9561
Miscelatore doccia incasso 1 via.
1-way built-in shower mixer.
Ø35



441CRCR9564
Miscelatore doccia incasso con
deviatore ceramico 2 vie.
*2-way built-in shower mixer with
ceramic diverter.*
Ø35



441CRCR9563
Miscelatore doccia incasso con
deviatore ceramico 3 vie.
*3-way built-in shower mixer with
ceramic diverter.*
Ø35



441NNNN9561
Miscelatore doccia incasso 1 via.
1-way built-in shower mixer.
Ø35



441NNNN9564
Miscelatore doccia incasso con
deviatore ceramico 2 vie.
*2-way built-in shower mixer with
ceramic diverter.*
Ø35



441NNNN9563
Miscelatore doccia incasso con
deviatore ceramico 3 vie.
*3-way built-in shower mixer with
ceramic diverter.*
Ø35

EASY COVER

Installa prima solo il corpo incasso
Install only the built-in body first

CORPI INCASSO BUILT-IN BODIES

1 USCITA _ 1 OUTLET
 35AC5001



2 USCITE _ 2 OUTLETS
 35AC5002



3 USCITE _ 3 OUTLETS
 35AC5003



>>

PIASTRE DISPONIBILI AVAILABLE PLATES

>>

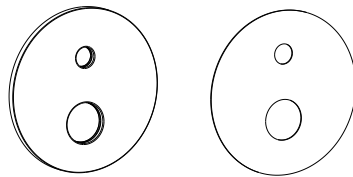

LAVABO A MURO PIASTRA UNICA E PIASTRE SEPARATE
 WALL BASIN MIXER WITH SINGLE HORIZONTAL PLATE AND SEPARATE PLATES

35AC5004

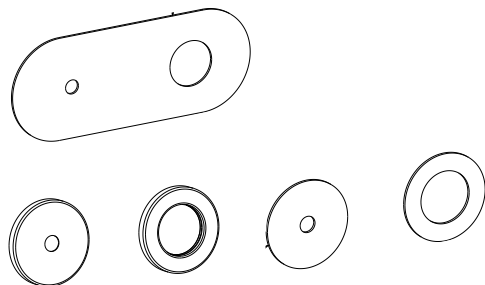

Decidi successivamente design e finitura delle parti esterne
Decide later design and finish of the external parts

PARTI ESTERNE EXTERNAL PARTS

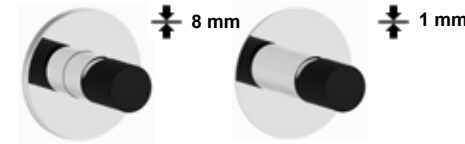

441CRCP7103

441CRCP7101

PARTE ESTERNA COMPLETA DI PIASTRA,
 LEVA E CAPPUCCIO

EXTERNAL PART COMPLETE WITH PLATE,
 LEVER AND CAP

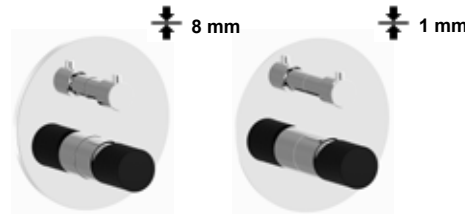

441CRCP7203

441CRCP7201

PARTE ESTERNA COMPLETA DI PIASTRA, LEVA,
 CAPPUCCIO, COPRIDEVIATORE E POMOLO

EXTERNAL PART COMPLETE WITH PLATE,
 LEVER, CAP, DIVERTER COVER AND KNOB

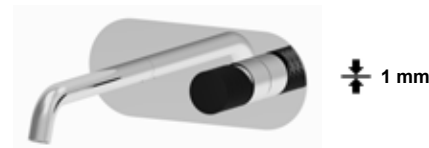

441CRCP9567

PARTI ESTERNE COMPLETE DI PIASTRA, LEVA,
 CAPPUCCIO, BOCCA E RACCORDO

EXTERNAL PARTS COMPLETE WITH PLATE,
 LEVER, CAP, SPOUT AND CONNECTION



441CRCP9587

441CRCP9597

XENON SLIM

>
444OS5240
Miscelatore lavabo medio.
Medium basin mixer.
Oro Scuro

Scegliere la serie Xenon Slim significa optare per un design essenziale, praticità e un'alta qualità costruttiva. Aggiungi un tocco di eleganza e modernità al tuo bagno con questa linea versatile, che ti permette di creare un ambiente bagno personalizzato e di alto livello.

Choosing Xenon Slim series means opting for essential design, practicality and high manufacturing quality. Add a touch of elegance and modernity to your bathroom with this versatile series, allowing you to create a personalised, high-end bathroom environment.





^
444CH5145
Miscelatore vasca a pavimento.
Floor-mounted bath mixer.
Champagne



^
444OS9513
Miscelatore lavabo a muro.
Wall basin mixer.
Oro Scuro



MET

444OC5250
Miscelatore lavabo alto.
One hole basin mixer, high body.
Oro chiaro



444AD5250
Miscelatore lavabo alto.
One hole basin mixer, high body.
Ardesia



^
444TS9523
Miscelatore lavabo a muro.
Wall basin mixer.
Terra di Siena
Ø35

444CH5230 >
Miscelatore lavabo.
One hole basin mixer.
Champagne

444OS5230 >
Miscelatore lavabo.
One hole basin mixer.
Oro scuro



MATT



444BL5240
Miscelatore lavabo medio.
One hole medium basin mixer.
Blu Notte
v

444GL5240
Miscelatore lavabo medio.
One hole medium basin mixer.
Glicine
v

444CI5240
Miscelatore lavabo medio.
One hole medium basin mixer.
Cipria
v



^
444AM5250
Miscelatore lavabo alto.
One hole basin mixer, high body.
Acquamarina

MEDIUM



444CR5230
Miscelatore lavabo.
One hole basin mixer.



444CR5240
Miscelatore lavabo.
One hole basin mixer.



444CR5250
Miscelatore lavabo alto.
One hole tall basin mixer.



444CR5155
Miscelatore bordo vasca
3-hole bath mixer.



444CR5170
Miscelatore doccia esterno.
External shower mixer.

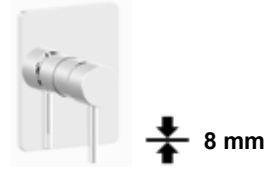

444CR9541
Miscelatore doccia incasso 1 via.
1-way built-in shower mixer.

Ø35



444CR5255
Miscelatore bidet.
One hole bidet mixer.



444CR9503
Miscelatore lavabo a muro.
Wall basin mixer.

Ø35



444CR9513
Miscelatore lavabo a muro.
Wall basin mixer.

Ø35



444CR9544
Miscelatore doccia incasso 2 vie
con deviatore ceramico.
*2-way built-in shower mixer with
ceramic diverter.*

Ø35



444CR9543
Miscelatore doccia incasso 3 vie
con deviatore ceramico.
*3-way built-in shower mixer
ceramic diverter.*

Ø35



444CR9561
Miscelatore doccia incasso 1-via.
1-way built-in shower mixer.

Ø35



444CR9523
Miscelatore lavabo a muro.
Wall basin mixer.

Ø35



444CR9533
Miscelatore lavabo a muro.
Wall basin mixer.

Ø35



444CR5150
Miscelatore vasca con duplex.
Bath mixer with shower set.

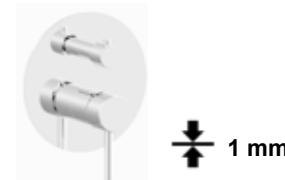

444CR9564
Miscelatore doccia incasso 2 vie
con deviatore ceramico.
*2-way built-in shower mixer with
ceramic diverter.*

Ø35



444CR9563
Miscelatore doccia incasso 3 vie
con deviatore ceramico.
*3-way built-in shower mixer with
ceramic diverter.*

Ø35



FINITURE DISPONIBILI / AVAILABLE FINISHINGS

N.B. Le leve di tutti gli articoli della serie avranno l'astina liscia.
P.S. The levers of all articles in the series will have a smooth rod.

EASY COVER

Installa prima solo il corpo incasso
Install only the built-in body first

CORPI INCASSO BUILT-IN BODIES

1 USCITA _ 1 OUTLET
 35AC5001



2 USCITE _ 2 OUTLETS
 35AC5002



3 USCITE _ 3 OUTLETS
 35AC5003



LAVABO A MURO PIASTRA UNICA E PIASTRE SEPARATE
 WALL BASIN MIXER WITH SINGLE HORIZONTAL PLATE AND SEPARATE PLATES

35AC5004



>>

PIASTRE DISPONIBILI AVAILABLE PLATES

>>

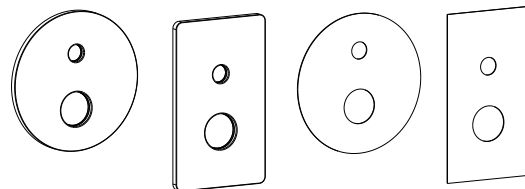

Decidi successivamente design e finitura delle parti esterne
Decide later design and finish of the external parts

PARTI ESTERNE EXTERNAL PARTS



PARTE ESTERNA COMPLETA DI PIASTRA,
 LEVA E CAPPUCCIO

EXTERNAL PART COMPLETE WITH PLATE,
 LEVER AND CAP

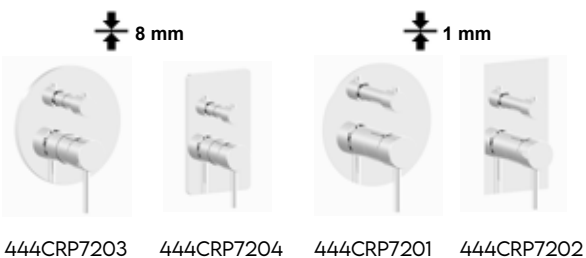

PARTE ESTERNA COMPLETA DI PIASTRA, LEVA,
 CAPPUCCIO, COPRIDEVIATORE E POMOLO

EXTERNAL PART COMPLETE WITH PLATE,
 LEVER, CAP, DIVERTER COVER AND KNOB



PARTI ESTERNE COMPLETE DI PIASTRA, LEVA,
 CAPPUCCIO, BOCCA E RACCORDO



EXTERNAL PARTS COMPLETE WITH PLATE,
 LEVER, CAP, SPOUT AND CONNECTION

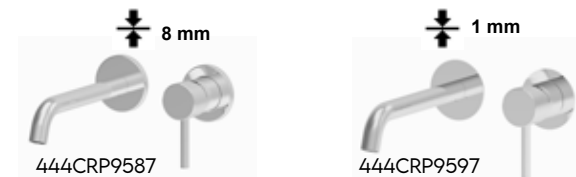

KUBE



Essenzialità e linearità sono le parole chiave che caratterizzano la serie Kube.

La geometria e le linee ortogonali rendono il prodotto moderno ed elegante, perfetto per ambienti bagno dal design minimal.

Simplicity and linearity are the key words that characterize the Kube series.

Geometry and orthogonal lines make the product modern and elegant, perfect for bathroom with minimal design.

^
1000S9535
Miscelatore lavabo a muro.
Wall basin mixer.
Oro scuro

Ø35



^
100RA8515
Miscelatore lavabo.
One hole basin mixer.
Rosa Antico



SCOPRI QUI TUTTE LE
NUOVE FINITURE

DISCOVER ALL THE NEW
FINISHINGS HERE

I colori pastello opachi sono ideali per chi predilige ambienti caratterizzati da tonalità delicate, creando spazi rilassanti e rigeneranti. Si specifica inoltre che tutti gli articoli con finitura opaca sono dotati di flessibili di colore bianco.

Matt pastel colours are ideal for those who prefer environments characterised by subtle tones, creating relaxing and regenerating spaces. It is also specified that all articles with a matt finish have white hoses.



^
100PR8517
Miscelatore lavabo alto.
One hole basin mixer, high body.
Perla Rosa

PERLA ROSA



^
100PR8545
Miscelatore per doccia esterno con
deviatore incorporato, colonna, soffione e
doccetta.
*Shower mixer with integrated diverter,
column, shower head and handshower.*



< 100NK8515
 Miscelatore lavabo.
One hole basin mixer.
 Nickel

FINITURE DISPONIBILI / AVAILABLE FINISHINGS

-  CR
Cromo / Chrome
-  NN
Nero opaco / Matt black
-  BB
Bianco opaco / Matt white
-  Collezione Primavera
-  OZ
Oro opaco
spazzolato



100CR8515
Miscelatore lavabo.
One hole basin mixer.



100CR8519
Miscelatore lavabo medio.
One hole medium basin mixer.



100CR8517
Miscelatore lavabo alto.
One hole tall basin mixer.



100CR8535
Miscelatore bidet.
One hole bidet mixer.



100CR9512
Miscelatore lavabo a muro.
Wall basin mixer.
Ø35



100CR8552
Miscelatore vasca con duplex.
Bath mixer with shower set.



100CR9541
Miscelatore doccia incasso
1 via.
1-way built-in shower mixer.
Ø35

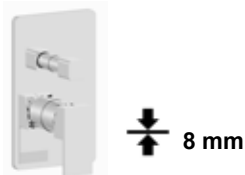

100CR9544
Miscelatore doccia incasso 2 vie
con deviatore ceramico.
*2-way built-in shower mixer with
ceramic diverter.*
Ø35

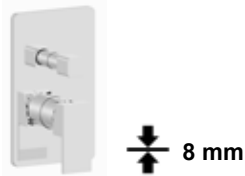

100CR9543
Miscelatore doccia incasso 3 vie
con deviatore ceramico.
*3-way built-in shower mixer
ceramic diverter.*
Ø35



100CR8554
Miscelatore vasca a
pavimento.
Floor-mounted bath mixer.



100OS8554
Miscelatore vasca a pavimento.
Floor-mounted bath mixer.
Oro Scuro

EASY K-BOX _ EASY COVER

Installa prima solo il corpo incasso
Install only the built-in body first

CORPI INCASSO BUILT-IN BODIES

1 USCITA _ 1 OUTLET
 35AC5001



2 USCITE _ 2 OUTLETS
 35AC5002



3 USCITE _ 3 OUTLETS
 35AC5003



>>

PIASTRE DISPONIBILI AVAILABLE PLATES

>>

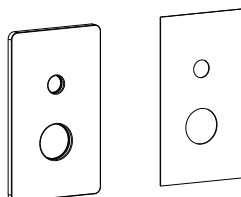
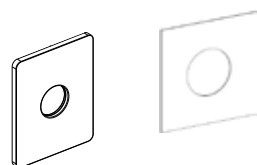

LAVABO A MURO PIASTRA UNICA E PIASTRE SEPARATE
 WALL BASIN MIXER WITH SINGLE HORIZONTAL PLATE AND SEPARATE PLATES

35AC5004

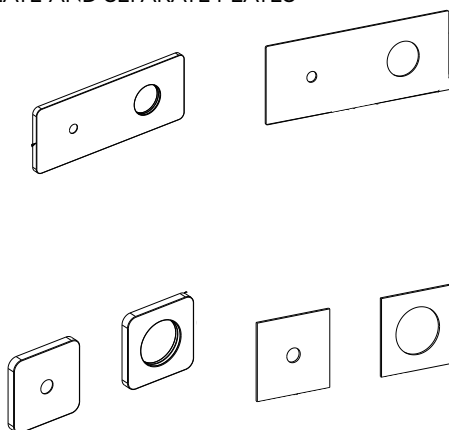

Decidi successivamente design e finitura delle parti esterne
Decide later design and finish of the external parts

PARTI ESTERNE EXTERNAL PARTS

8 mm



100CRP7104

1 mm



100CRP7102

PARTE ESTERNA COMPLETA DI PIASTRA,
 LEVA E CAPPUCCIO

EXTERNAL PART COMPLETE WITH PLATE,
 LEVER AND CAP

8 mm



100CRP7204

1 mm



100CRP7202

PARTE ESTERNA COMPLETA DI PIASTRA, LEVA,
 CAPPUCCIO, COPRIDEVIATORE E POMOLO

EXTERNAL PART COMPLETE WITH PLATE,
 LEVER, CAP, DIVERTER COVER AND KNOB

8 mm



100CRP9558

1 mm



100CRP9578

PARTI ESTERNE COMPLETE DI PIASTRA, LEVA,
 CAPPUCCIO, BOCCA E RACCORDO

EXTERNAL PARTS COMPLETE WITH PLATE,
 LEVER, CAP, SPOUT AND CONNECTION

8 mm



100CRP9548

1 mm



100CRP9508

Un connubio di eleganza e minimalismo, la ricerca del bello e la garanzia di un prodotto solido e funzionale. Le linee marcate e maschili sono addolcite da curve più sinuose e femminili. Dark. Essenziale e di carattere, innovativo ed appagante. Per chi vuole vivere il bagno come il luogo del proprio essere.

A blend of elegance and minimalism, the search for beauty and the pursuit of functionality and robustness. The pronounced and masculine lines get softened by sinuous and feminine curves.

Dark. Essential and full of character, innovative and fulfilling. For those who want to live their bathroom as a reflection of their own being.



^
14OCI4415
Miscelatore lavabo medio.
Medium basin mixer.
Cipria

DARK



< **140TO4415**
Miscelatore lavabo medio.
Medium basin mixer.
Tortora



140TO4454 >
Miscelatore vasca a pavimento.
Floor-mounted bath mixer.
Tortora



^
140TS4415
Miscelatore lavabo medio.
Medium basin mixer.
Terra di Siena



FINITURE DISPONIBILI / AVAILABLE FINISHINGS

-  CR
Cromo / Chrome
-  NN
Nero opaco / Matt black
-  BB
Bianco opaco / Matt white
-  Collezione Primavera
-  OZ
Oro opaco spazzolato

^
14ORA4417
Miscelatore lavabo alto.
One hole basin mixer, high body.
Rosa Antico

14ONK7576
Miscelatore doccia incasso 2 vie.
2-way built-in shower mixer.
Nickel

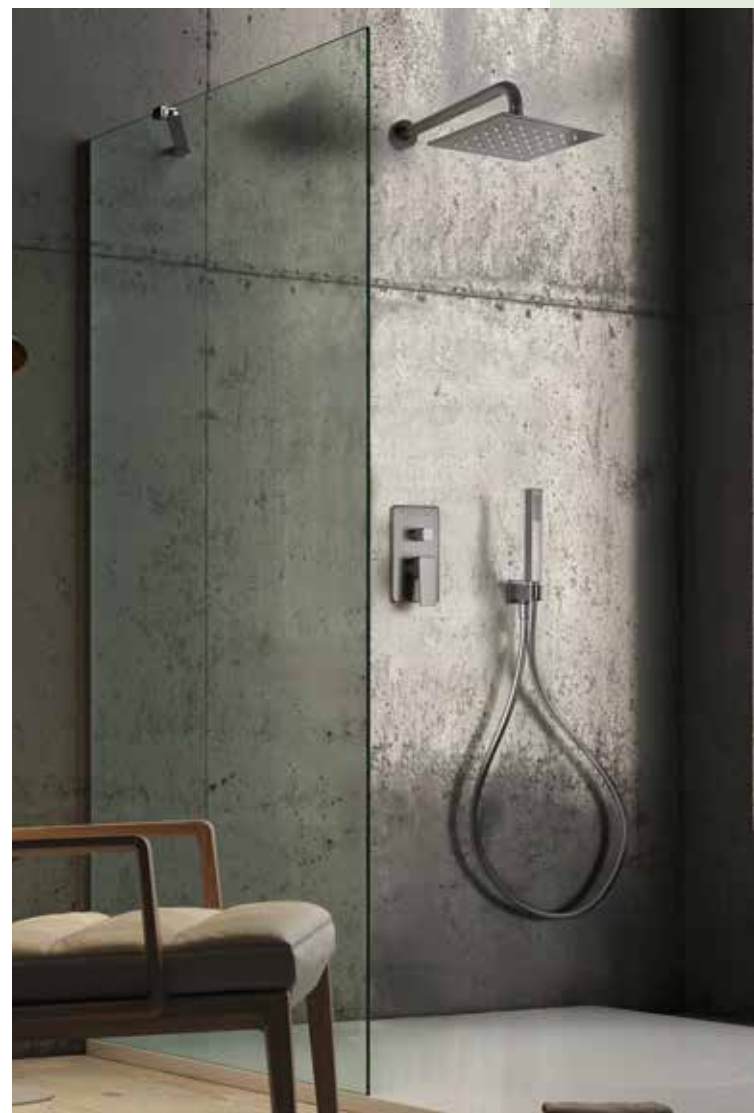

^
14OCR4454
Miscelatore vasca a pavimento.
Floor-mounted bath mixer.
Cromo



140CR4412
Miscelatore lavabo.
One hole basin mixer.



140CR4415
Miscelatore lavabo medio.
One hole medium basin mixer.



140CR4417
Miscelatore lavabo alto.
One hole tall basin mixer.



140CR4455
Bordo vasca 4 fori.
4-hole bath mixer.



140CR4461
Miscelatore doccia esterno
con duplex.
*External shower mixer
with shower set.*



140CR4470
Miscelatore doccia esterno,
attacco superiore.
*External shower mixer, upper
connection.*



140CR4430
Miscelatore bidet.
One hole bidet mixer.



140CR4445
Miscelatore lavabo 2 fori.
2-hole basin mixer.



140CR4440
Miscelatore lavabo 3 fori.
3-hole basin mixer.



140CR7507
Miscelatore doccia incasso 1 via.
1-way built-in shower mixer.
Ø35



140CR7512
Miscelatore doccia incasso
con deviatore 2 vie.
*2-way built-in shower
mixer.*
Ø35



140CR7576
Miscelatore doccia incasso con
deviatore ceramico 2 vie.
*2-way built-in shower mixer with
ceramic diverter.*
Ø35



140CR9518
Miscelatore lavabo a muro.
Wall basin mixer.
Ø35



140CR9532
Miscelatore lavabo a muro.
Wall basin mixer.
Ø35



140CR4451
Miscelatore vasca con duplex.
Bath mixer with shower set.



140CR7577
Miscelatore doccia incasso con
deviatore ceramico 3 vie.
*3-way built-in shower mixer with
ceramic diverter.*
Ø35



140CR4454
Miscelatore vasca a
pavimento.
Floor-mounted bath mixer.



140NN4412
Miscelatore lavabo.
One hole basin mixer.



140NN4415
Miscelatore lavabo medio.
One hole medium basin mixer.



140NN4417
Miscelatore lavabo alto.
One hole tall basin mixer.



140NN4455
Bordo vasca 4 fori.
4-hole bath mixer.



140NN4461
Miscelatore doccia esterno
con duplex.
*External shower mixer
with shower set.*



140NN4470
Miscelatore doccia esterno,
attacco superiore.
*External shower mixer, upper
connection.*



140NN4430
Miscelatore bidet.
One hole bidet mixer.



140NN4445
Miscelatore lavabo 2 fori.
2-hole basin mixer.



140NN4440
Miscelatore lavabo 3 fori.
3-hole basin mixer.



140NN7507
Miscelatore doccia incasso 1 via.
1-way built-in shower mixer.
Ø35



140NN7512
Miscelatore doccia incasso
con deviatore 2 vie.
*2-way built-in shower
mixer.*
Ø35



140NN7576
Miscelatore doccia incasso con
deviatore ceramico 2 vie.
*2-way built-in shower mixer with
ceramic diverter.*
Ø35



140NN9518
Miscelatore lavabo a muro.
Wall basin mixer.
Ø35



140NN9532
Miscelatore lavabo a muro.
Wall basin mixer.
Ø35



140NN4451
Miscelatore vasca con duplex.
Bath mixer with shower set.



140NN7577
Miscelatore doccia incasso con
deviatore ceramico 3 vie.
*3-way built-in shower mixer with
ceramic diverter.*
Ø35



140NN4454
Miscelatore vasca a
pavimento.
Floor-mounted bath mixer.

XENON STEEL

Xenon Steel, una serie completa prodotta totalmente in acciaio inox 316L. L'acciaio inox è un materiale sano, duraturo, atossico: non contiene tracce di piombo e non rilascia nichel.

A livello produttivo viene trattato solo meccanicamente, non subisce alcun processo chimico che può essere causa di inquinamento.

Garantisce una durata eccezionale, data la sua solidità, ed è uno dei materiali migliori per il contatto con l'acqua potabile.

Xenon Steel, a complete series made entirely of 316L stainless steel. Stainless steel is a healthy, durable, non-toxic material: it contains no traces of lead and does not release nickel. At the production level it is only treated mechanically, it does not undergo any chemical process that can cause pollution. It guarantees exceptional durability, given its solidity, and is one of the best materials for contact with drinking water.



100%

ACCIAIO
INOX
AISI 316L

STAINLESS
STEEL
AISI 316L

< 440AI7120
Miscelatore lavabo.
One hole basin mixer.



^
440AI7120
Miscelatore lavabo.
One hole basin mixer.

440AI7125
Miscelatore lavabo alto.
One hole tall basin mixer.

PRODUCT SELECTION



440AI7120
Miscelatore lavabo
One hole basin mixer



440AI7125
Miscelatore lavabo alto
One hole tall basin mixer



440AI7130
Miscelatore bidet
One hole bidet mixer



440AI7140
Miscelatore lavabo a muro
Wall basin mixer



440AI7155
Miscelatore bordo vasca 4 fori
4-hole bath mixer



440AI7150
Miscelatore vasca
Bath mixer
*



440AI7160
Miscelatore vasca termostatico
Thermostatic bath mixer
*



440AI7165
Miscelatore doccia esterno
termostatico
*Thermostatic external
shower mixer*
*



440AI7170
Miscelatore doccia esterno
External shower mixer
*

* N.B
Corpo esterno in acciaio inossidabile 316L, anima interna in ottone
316L stainless steel outer body, internal core in brass



440AI7180
Miscelatore doccia incasso 1 via.
1-way built-in shower mixer.



440AI7185
Miscelatore doccia incasso
con deviatore 2 vie
*2-way built-in shower mixer
with diverter*

440AI7190
Miscelatore doccia incasso 1
via con corpo in ottone
*1-way built-in shower mixer with
brass built-in body*

440AI7195
Miscelatore doccia incasso con
deviatore 2 vie con corpo in
ottone
*2-way built-in shower mixer with
diverter with brass built-in body*



30AI8730
Kit doccetta con supporto,
presa acqua, doccetta e
flessibile
*Shower kit with holder,
intake of water, handshower
and satilux flexible*



30AI8670
Braccio doccia con soffione
ø200 mm ultrasottile
*Shower arm with ø200 mm ultra-
thin showerhead*



30AI0390
Saliscendi con doccetta,
supporto e flessibile
*Sliding rail with handshower,
holder and flexible*



440AI7175
Colonna doccia bordopiscina
outdoor 2 vie.
*2-way outdoor shower column for
swimming pool*



440AI7145
Miscelatore lavabo a pavimento
Floor-mounted basin mixer



440AI7157
Miscelatore vasca a pavimento
Floor-mounted bath mixer



30AI8731
Kit con supporto,
doccetta e flessibile
*Shower kit with holder,
handshower and satilux
flexible*



30AI8671
Braccio doccia con soffione
ø200 mm ultrasottile
*Shower arm with ø200 mm ultra-
thin showerhead*



30AI8861
Corpo incasso per miscelatori a
pavimento
*Built-in body for floor-mounted
mixers*



30AI8855
Sifone tondo minimalista
Minimalist round siphon



30AI8860
Scarico click clack 1"1/4
1"1/4 click clack pop up waste



440AI0964
Miscelatore termostatico per
doccia esterno, versione comple-
ta di colonna, soffione e doccetta
monogetto
*Thermostatic shower mixer with
column, shower head and
handshower.*

KERA

L'eleganza e la morbidezza lineare sono gli elementi distintivi di questa nuova serie.

Kera propone una leva che riprende la geometria del corpo e la morbidezza lineare, adatta per chi preferisce l'eleganza e la coerenza formale.

Elegance and linear softness are the distinctive elements of this new series.



Kera proposes a lever that reproduces the geometry of the body and the curved lines, suitable for those who prefer the elegance and formal coherence.



^
88CR5515
Miscelatore lavabo.
One hole basin mixer.
Cromo



FINITURE DISPONIBILI / AVAILABLE FINISHINGS

- 
CR
Cromo / Chrome
- 
NN
Nero opaco / Matt black
- 
BB
Bianco opaco / Matt white
- 
Collezione Primavera



88NN5515
Miscelatore lavabo.
Basin mixer.
Nero opaco /
Matt black
▼



NERO
OPA -
CO

PRODUCT SELECTION



88CR5515
Miscelatore lavabo.
One hole basin mixer.



88CR5514
Miscelatore lavabo alto.
One hole tall basin mixer.



88CR5535
Miscelatore bidet.
One hole bidet mixer.



88CR5550
Miscelatore vasca con duplex.
Bath mixer with shower set.



88CR5540
Miscelatore doccia esterno.
External shower mixer.



88CR7565
Miscelatore doccia incasso
1 via.
1-way built-in shower mixer.



88CR7506
Miscelatore doccia incasso
con deviatore, 2 vie.
2-way built-in shower mixer.

KATANA

Con Katana, il design minimalista incontra la qualità artigianale. Le sue linee essenziali e moderne donano un tocco di eleganza a qualsiasi ambiente. Realizzato in ottone di alta qualità, garantisce resistenza e brillantezza che durano nel tempo. La leva sottile, invece, permette un movimento fluido e preciso.

With Katana, minimalist design meets craftsmanship quality. Its essential and modern lines bring a touch of elegance to any environment.

Made of high-quality brass, it ensures durability and lasting brilliance. Its slim lever allows a smooth and precise movement.



^
77CR7520
Miscelatore lavabo.
One hole basin mixer.
Cromo



FINITURE DISPONIBILI / AVAILABLE FINISHINGS

-  CR
Cromo / Chrome
-  NN
Nero opaco / Matt black



77CR7724 >
Miscelatore lavabo a muro
Wall basin mixer.
Cromo



^
77CR7550
Miscelatore vasca con duplex.
Bath mixer with shower set.
Cromo



^
77CR7520
Miscelatore lavabo.
One hole basin mixer.
Cromo

PRODUCT SELECTION



77CR7520
Miscelatore lavabo.
One hole basin mixer.



77CR7591
Miscelatore lavabo alto.
One hole tall basin mixer.



77CR7530
Miscelatore bidet.
One hole bidet mixer.



77CR9535
Miscelatore lavabo a muro.
Wall basin mixer.

Ø35



77CR7550
Miscelatore vasca con duplex.
Bath mixer with shower set.



77CR7575
Miscelatore doccia esterno.
External shower mixer.



77CR7515
Miscelatore doccia incasso
1 via.
1-way built-in shower mixer.



77CR7517
Miscelatore doccia incasso
con deviatore, 2 vie.
2-way built-in shower mixer.

XENON

Il modello XENON rappresenta l'essenza del design moderno.

Realizzato in finitura cromata lucida, si distingue per la sua eleganza e raffinatezza, ideale per ambienti bagno contemporanei.

La linea slanciata e cilindrica del corpo del rubinetto, unita alla leva sottile e lineare, offre un equilibrio perfetto tra estetica e funzionalità. La bocca di erogazione, leggermente incurvata, non solo facilita il flusso dell'acqua, ma aggiunge un tocco di morbidezza visiva al design. Scegliendo XENON, si opta per un rubinetto che non è solo un accessorio funzionale, ma un vero e proprio elemento d'arredo per il bagno. Un simbolo di stile e qualità, firmato Fiore Rubinetterie, sinonimo di eccellenza dal 1965.

Our XENON represents the essence of modern design.

Made in a shiny chrome finish, it stands out for its elegance and refinement, ideal for contemporary bathrooms.

The slender and cylindrical shape of the tap body, combined with the thin and linear lever, offers a perfect balance between aesthetics and functionality. The slightly curved spout not only facilitates the flow of water, but also adds a touch of visual softness to the design.

By choosing XENON, you opt for a tap that is not just a functional accessory, but a real furnishing element for your bathroom. A symbol of style and quality, signed by Fiore Rubinetterie, synonym for excellence since 1965.



^
44CR5288
Miscelatore lavabo alto.
One hole basin mixer, high body.
Cromo



FINITURE DISPONIBILI / AVAILABLE FINISHINGS

- 
CR
Cromo / Chrome
- 
NN
Nero opaco / Matt black
- 
AA
Simil acciaio / Steel



^
44CR5262
Miscelatore lavabo a cascata.
Waterfall basin mixer.
Cromo



44CR5283
Miscelatore lavabo.
One hole basin mixer.



44CR5288
Miscelatore lavabo alto.
One hole tall basin mixer.



44CR5371
Miscelatore bidet.
One hole bidet mixer.



44CR9533
Miscelatore lavabo a muro.
Wall basin mixer.
Ø35



44CR5173
Miscelatore doccia esterno con
deviatore incorporato, attacco
superiore e inferiore.
*External shower mixer with
integrated diverter, upper and
lower connection.*



44CR5150
Miscelatore vasca con duplex.
Bath mixer with shower set.



44CR7515
Miscelatore doccia incasso 1via.
1-way built-in shower mixer.



44CR7517
Miscelatore doccia incasso con
deviatore, 2 vie.
2-way built-in shower mixer.



44CR5145
Miscelatore vasca a
pavimento.
Floor-mounted bath mixer.

KALOS

Linee squadrate e dettagli curati sono l'essenza della nostra KALOS, realizzata interamente in ottone cromato di alta qualità.

La base solida e squadrata crea un senso di stabilità perfetta in qualsiasi contesto, dal classico al contemporaneo.

Ogni dettaglio riflette la passione per il design e l'artigianalità italiana, con oltre cinquant'anni di esperienza garantiti da Fiore Rubinetterie.

Square lines and refined details are the essence of our KALOS, made entirely of high quality chromed brass.

The solid, square base creates a sense of perfect stability in any context, from classic to contemporary.

Every detail reflects the passion for Italian design and craftsmanship, with over fifty years of experience guaranteed by Fiore Rubinetterie.



^
76CR7420
Miscelatore lavabo.
One hole basin mixer.
Cromo



FINITURE DISPONIBILI / AVAILABLE FINISHINGS

-  CR
Cromo / Chrome
-  NN
Nero opaco / Matt black



^
76CR7420
Miscelatore lavabo.
One hole basin mixer.
Cromo

PRODUCT SELECTION



76CR7420
Miscelatore lavabo.
One hole basin mixer.



76CR7430
Miscelatore bidet.
One hole bidet mixer.



76CR7427
Miscelatore lavabo a muro.
Wall basin mixer.



76CR7450
Miscelatore vasca con duplex.
Bath mixer with shower set.



76CR7475
Miscelatore doccia esterno.
External shower mixer.



76CR7415
Miscelatore doccia incasso 1 via.
1-way built-in shower mixer.



76CR7417
Miscelatore doccia incasso
con deviatore, 2 vie.
2-way built-in shower mixer.

KEVON

KEVON rappresenta la perfetta combinazione di design e funzionalità, pensato per chi desidera uno stile senza tempo che sappia valorizzare ogni ambiente bagno. Il suo design evergreen si adatta con facilità a tutti i gusti, grazie alla sua linea sobria e raffinata. Minimal ma mai scontato, KEVON conquista per la sua eleganza discreta che non rinuncia al carattere. È un miscelatore classico nelle forme, ma con piccoli dettagli di design che fanno davvero la differenza, trasformandolo in un elemento distintivo e ricercato. Scegliere KEVON significa optare per un prodotto capace di resistere al passare delle mode, unendo stile e qualità in un equilibrio perfetto.



KEVON represents the perfect combination of design and functionality, designed for those who desire a timeless style that can enhance any bathroom environment. Its evergreen design easily adapts to all tastes, thanks to its sober and refined line. Minimal but never obvious, KEVON conquers with its discreet elegance that does not give up character. It is a mixer that is classic in form, but with small design details that really make a difference, transforming it into a distinctive and sought-after element. Choosing KEVON means opting for a product capable of resisting the passing of fashions, combining style and quality in a perfect balance.



^
81CR8120
Miscelatore lavabo.
One hole basin mixer.
Cromo



FINITURE DISPONIBILI / AVAILABLE FINISHINGS

- 
CR
Cromo / Chrome
- 
NN
Nero opaco / Matt black

^
81CR8119
Miscelatore lavabo alto.
One hole basin mixer, high body.
Cromo





81NN8119 >
Miscelatore lavabo alto.
*One hole basin mixer,
high body.*
Nero opaco



^
81NN8123
Miscelatore lavabo.
One hole basin mixer.
Nero opaco

PRODUCT SELECTION



81CR8120
Miscelatore lavabo.
One hole basin mixer.



81CR8123
Miscelatore lavabo medio.
One hole medium basin mixer.



81CR8119
Miscelatore lavabo alto.
One hole basin mixer, high body.



81CR8130
Miscelatore bidet.
One hole bidet mixer.



81CR8150
Miscelatore vasca con duplex.
Bath mixer with shower set.



81CR1500
Miscelatore vasca con duplex.
Bath mixer with shower set.



81CR6511
Miscelatore doccia esterno.
External shower mixer.



81CR6515
Miscelatore doccia incasso 1 via.
1-way built-in shower mixer.



81CR6517
Miscelatore doccia incasso con deviatore, 2 vie.
2-way built-in shower mixer.



30CR8781
Soffioncino body spray.
Body jet spray shower.

30CR8631
Soffione Ø300 mm ultrasottile con braccio doccia.
Ultrathin Ø300 mm shower head with shower arm.

30CR8786
Kit doccia.
Shower kit.

KYRO



Perfetto per aggiungere un tocco di eleganza al tuo bagno.
Con il design raffinato della linea KYRO, trasformi ogni dettaglio in stile.

*Perfect for adding a touch of elegance to your bathroom.
With the refined design of the KYRO line, turn every detail into style.*

^
86CR8110
Miscelatore lavabo.
One hole basin mixer.
Cromo



FINITURE DISPONIBILI / AVAILABLE FINISHINGS



^
86CR8110
Miscelatore lavabo.
One hole basin mixer.
Cromo



86CR8110
Miscelatore lavabo.
One hole basin mixer.
Cromo



86CR8110
Miscelatore lavabo.
One hole basin mixer.



86CR8112
Miscelatore lavabo medio.
One hole medium basin mixer.



86CR8135
Miscelatore bidet.
One hole bidet mixer.



86CR8119
Miscelatore lavabo alto.
One hole tall basin mixer.



86CR8151
Miscelatore vasca con duplex.
Bath mixer with shower set.



86CR1500
Miscelatore vasca con duplex.
Bath mixer with shower set.



86CR6511
Miscelatore doccia esterno.
External shower mixer.



86CR6515
Miscelatore doccia incasso 1 via.
1-way built-in shower mixer.



86CR6517
Miscelatore doccia incasso
con deviatore, 2 vie.
2-way built-in shower mixer.

EXPERIENCE
FIORE

THE BEST
SOLUTION
FOR YOUR
BATHROOM



19OSB400
Porta asciugamano.
Towel holder.
Oro Scuro
v

ACCESSORI BAGNO

BATHROOM ACCESSORIES

PRODUCT SELECTION

ACCESSORI BAGNO

COMATT COLORS

Square

MET COLORS

QUADRO

Square



19OAC601
Appendino
Hook

19OAC011
Porta sapone
Wall mounted soap dish

19OAC400
Porta asciugamano
Towel holder

19OAC211
Porta dosatore sapone liquido
Wall mounted liquid soap
dispenser



19CBC601
Appendino
Hook

19CBC011
Porta sapone
Wall mounted soap dish

19CBC400
Porta asciugamano
Towel holder

19CBC211
Porta dosatore sapone liquido
Wall mounted liquid soap
dispenser



ACCESSORI BAGNO
BATHROOM ACCESSORIES

PRODUCT SELECTION

ACCESSORI BAGNO

TONDO
Round

MET
COLORS

TONDO
Round



ARDESIA



ORO
CHIARO



CHAMPAGNE



ORO
SCURO

19CHB130
Porta bicchiere
Wall mounted tumbler

19CHB400
Porta asciugamano
Towel holder

19CHB210
Porta dosatore sapone liquido
Wall mounted liquid soap dispenser

ACCESSORI BAGNO
BATHROOM ACCESSORIES



19OSB130
Porta bicchiere
Wall mounted tumbler

19OSB400
Porta asciugamano
Towel holder

19OSB210
Porta dosatore sapone liquido
Wall mounted liquid soap dispenser

19OSB010
Porta sapone
Wall mounted soap

19OSB510
Porta bicchiere
Wall mounted tumbler

19OSB601
Appendino
Hook

19OSB602
Appendino
Hook

JAFAR

Il rubinetto JAFAR non è solo funzionalità, è un'esperienza di design che eleva l'ambiente rendendolo accogliente e sofisticato, ideale per completare con eleganza ambienti dal gusto classico. Con il suo design sfarzoso e le sue linee morbide, riesce a catturare lo sguardo e a trasmettere un senso di raffinatezza. Ogni dettaglio, dai profili sinuosi alla finitura pregiata, dona un tocco di lusso e personalità all'ambiente. I particolari lo rendono unico nel suo genere, perfetto per chi desidera un rubinetto che non passi inosservato, ma che al contempo si integri armoniosamente in contesti di grande stile.

The JAFAR faucet is more than just functionality; it is a design experience that elevates the environment by making it cozy and sophisticated, ideal for elegantly complementing classically styled rooms. With its lavish design and soft lines, it manages to catch the eye and convey a sense of sophistication. Every detail, from the sinuous profiles to the fine finish, lends a touch of luxury and personality to the room. The details make it one-of-a-kind, perfect for those who want a faucet that will not go unnoticed, but at the same time blend harmoniously into stylish settings.



^
47CR5221
Miscelatore lavabo.
One hole basin mixer.
Cromo



FINITURE DISPONIBILI / AVAILABLE FINISHINGS

-  CR
Cromo / Chrome
-  OO
Oro / Gold
-  ZZ
Vecchio bronzo
Old bronze
-  RR
Vecchio rame
Old copper
-  OR
Oro rosa
Rose gold

^
47CR5134
Miscelatore doccia incasso con deviatore 2 vie .
2-way built-in shower mixer with diverter.
Cromo

PRODUCT SELECTION



47CR5221
Miscelatore lavabo.
One hole basin mixer.



47CR5225
Miscelatore lavabo.
One hole basin mixer.



47CR5321
Miscelatore bidet.
One hole bidet mixer.



47CR5104
Miscelatore vasca.
Bath mixer.



47CR5127
Miscelatore doccia esterno.
External shower mixer.



47CR5105
Miscelatore bordo vasca 3 fori.
3-hole bath mixer.



47CR5130
Miscelatore doccia incasso 1 via.
1-way built-in shower mixer.



47CR5134
Miscelatore doccia incasso con deviatore, 2 vie.
2-way built-in shower mixer.



30 0394 05
Set saliscendi 64-18 con doccia
Antica imp. ceram. bianca 1g.
testa d.7,5 cm flex doppia
aggraffatura.

*Sliding rail set 64-18 with single
jet white ceramic shower
Ø7,5 cm, double seam flexible.*



84 _ JAFAR SKY



89 _ IMPERIALE BLACK
Black ceramic knob



82 _ IMPERIALE SKY

LEVE DISPONIBILI
AVAILABLE LEVERS

MARGOT

Eleganza, raffinatezza e cura per i dettagli: il nostro rubinetto MARGOT ne è la prova. Le sue linee morbide e la finitura evocano il fascino senza tempo delle ambientazioni classiche, riportando alla mente l'eleganza delle dimore d'epoca.

Ogni elemento è studiato per esaltare il suo carattere unico, i simboli di tradizione e artigianalità.

Perfetto per chi ama circondarsi di dettagli particolari, questo rubinetto aggiunge un tocco di sfarzo e di calore alla stanza, trasformandola in un'oasi di classe e benessere.

Elegance, refinement and attention to detail: our MARGOT faucet is proof of this. Its soft lines and finish evoke the timeless charm of classic settings, bringing to mind the elegance of period homes.

Each element is designed to enhance its unique character, symbols of tradition and craftsmanship.

Perfect for those who love to surround themselves with special details, this faucet adds a touch of glitz and warmth to the room, transforming it into an oasis of class and well-being.



^
26ZZ0622
Monoforo lavabo.
One hole basin mixer.
Vecchio bronzo

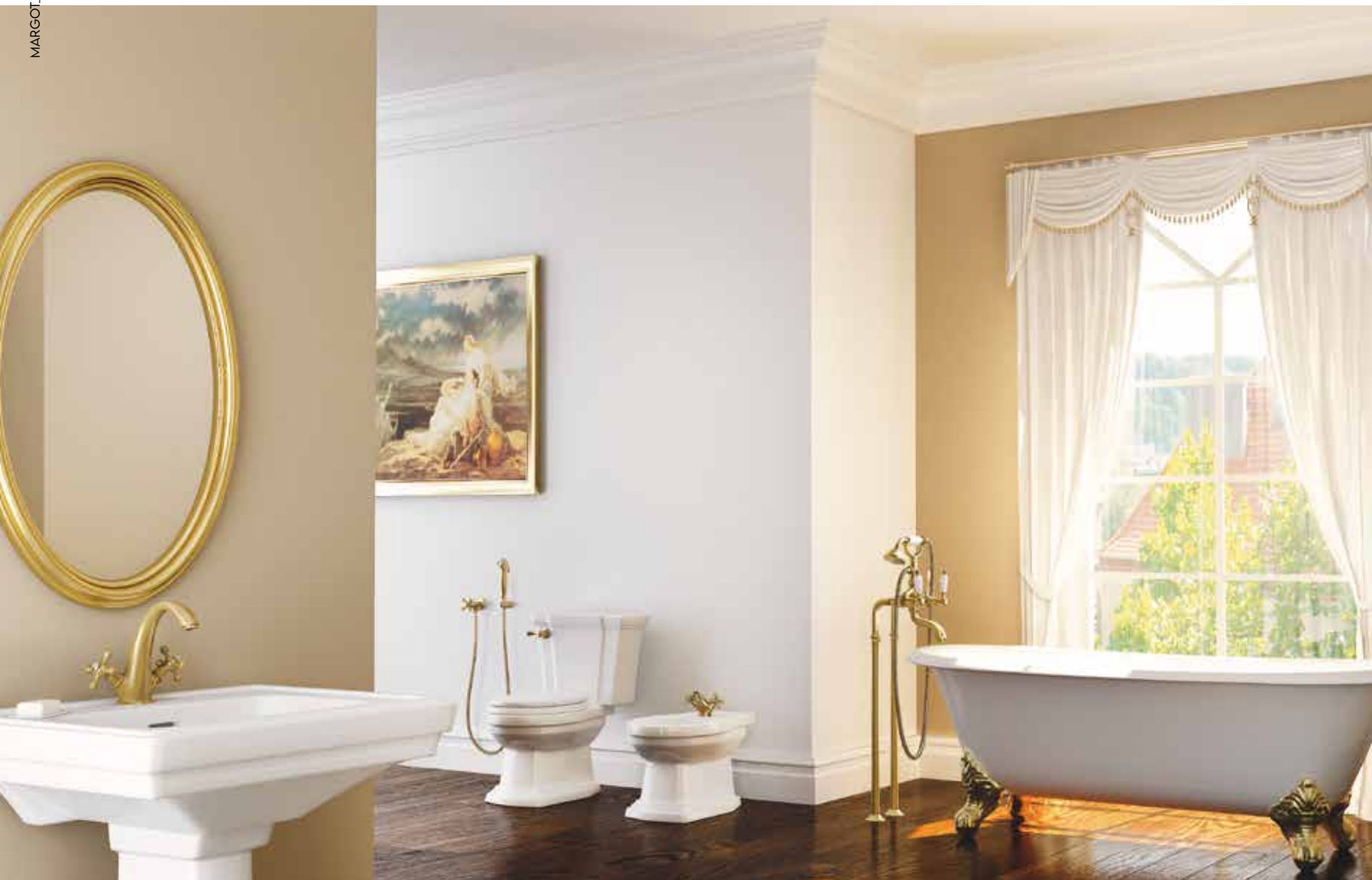

^
26ZZ0623
Monoforo lavabo.
One hole basin mixer.
Vecchio bronzo

FINITURE DISPONIBILI / AVAILABLE FINISHINGS

-  CR
Cromo / Chrome
-  OO
Oro / Gold
-  ZZ
Vecchio bronzo
Old bronze
-  RR
Vecchio rame
Old copper
-  OR
Oro rosa
Rose gold

PRODUCT SELECTION

MARGOT _ RETRÒ



26CR0623
Monoforo lavabo.
One hole basin mixer.



26CR0625
Monoforo lavabo.
One hole basin mixer.



26CR0628
Batteria lavabo 3 fori.
3-hole basin mixer.



26CR0632
Monoforo bidet.
One hole bidet mixer.



26CR0600
Gruppo vasca.
Bath mixer.



26CR0615
Gruppo vasca con colonna.
Bath mixer with rail.

26CR0608
Bordo vasca 5 fori.
5-hole bath mixer.



01 _ MARGOT SKY



08 _ GIOIELLI



09 _ GIOIELLI SKY



02 _ COLONIALE



03 _ COLONIALE SKY



22 _ COLONIALE BLACK
Black ceramic knob

LEVE DISPONIBILI
AVAILABLE LEVERS

EXPERIENCE
FIORE

WELLNESS

THE BEST
SOLUTION
FOR YOUR
BATHROOM





44CR0964
Miscelatore termostatico per doccia esterno, versione completa di colonna telescopica, soffione e doccetta monogetto.

Thermostatic shower mixer with telescopic column, shower head and monospray handshower.



100CR0963
Miscelatore termostatico per doccia esterno, versione completa di colonna telescopica, soffione e doccetta monogetto.

Thermostatic shower mixer with telescopic column, shower head and monospray handshower.



44CR5193
Miscelatore doccia esterno con deviatore incorporato, colonna doccia, soffione Ø200 mm, doccetta monogetto e flessibile.

Shower mixer with integrated diverter, column, shower head Ø200 mm, monospray handshower and flexible.



100CR8545
Miscelatore doccia esterno con deviatore incorporato, colonna doccia, soffione 200x200 mm, doccetta monogetto e flessibile.

Shower mixer with integrated diverter, column, shower head 200x200 mm, monospray handshower and flexible.



30 0590 50
Colonna doccia esterna con soffione 240x240 mm e doccetta monogetto e supporto scorrevole.

External shower column with 240x240 mm shower head, monospray handshower and sliding holder.



30 0590 00
Colonna doccia con soffione in ABS Ø 200 mm, deviatore, flex e doccia idromassaggio.

Shower column with Ø 200 mm chrome ABS shower head, diverter, flex and massage shower.

PRODUCT SELECTION



DISPONIBILE NELLE FINITURE
DELLA COLLEZIONE PRIMAVERA

AVAILABLE IN THE PRIMAVERA
COLLECTION FINISHINGS

30CH3001

Saliscendi tondo Ø20 mm, H90 cm, scorrevole con supporto regolabile completo di doccetta monogetto e flessibile satilux.

Round sliding rail Ø20 mm, H90 cm, monospray handshower and satilux flex. hose.



DISPONIBILE NELLE FINITURE
DELLA COLLEZIONE PRIMAVERA

AVAILABLE IN THE PRIMAVERA
COLLECTION FINISHINGS

30CH3501

Saliscendi in ottone quadro, asta 10x30 mm, lunghezza 70cm, completo di doccetta monogetto e flessibile 150 cm.

Square sliding rail, 10x30 mm, length 70 cm, monospray handshower and flex. hose cm 150.

**30 0395 00**

Set saliscendi 62-25 con doccia Siro 3g. testa d.10 cm flex doppia aggraffatura portasapone trasparente.

Sliding rail set 62-25 with 3-jet Siro shower Ø 10 cm, transparent soap dish.

**30 0392 05**

Set saliscendi 70-22 con doccia Salia 5g. testa d.12 cm flex doppia aggraffatura.

Sliding rail set 70-22 with Salia 5-jet shower Ø 12 cm, double seam flexible.

**30 0394 05**

Set saliscendi 64-18 con doccia Antica imp. ceram. bianca 1g. testa d.7,5 cm flex doppia aggraffatura.

Sliding rail set 64-18 with single jet white ceramic shower Ø7,5 cm, double seam flexible.

**31CR0956**

Miscelatore termostatico doccia esterno senza duplex.
Thermostatic shower mixer without shower set.

31CR0957

Miscelatore termostatico doccia esterno senza duplex, attacco superiore e inferiore.
Thermostatic shower mixer without shower set, upper and lower connection.

**31CR0958**

Miscelatore termostatico doccia esterno senza duplex.
Thermostatic shower mixer without shower set.

31CR0959

Miscelatore termostatico doccia esterno senza duplex, attacco superiore e inferiore.
Thermostatic shower mixer without shower set, upper and lower connection.



Soffioni ispezionabili in acciaio
Shower heads in stainless steel open for cleaning

30CR8633

Soffione Ø200 mm con braccio 350 mm.
Shower head Ø200 mm with inlet arm 350 mm.

30CR8634

Soffione Ø300 mm con braccio 350 mm.
Shower head Ø300 mm with inlet arm 350 mm.

30CR8635

Soffione Ø400 mm con braccio 500 mm.
Shower head Ø400 mm with inlet arm 500 mm.



Soffioni in acciaio ultra sottile
Ultra-thin shower heads in stainless steel

30CR8630

Soffione Ø200 mm con braccio 350 mm.
Shower head Ø200 mm with inlet arm 350 mm.

30CR8631

Soffione Ø300 mm con braccio 350 mm.
Shower head Ø300 mm with inlet arm 350 mm.

30CR8632

Soffione Ø400 mm con braccio 500 mm.
Shower head Ø400 mm with inlet arm 500 mm.

PRODUCT SELECTION



44NN0932
Miscelatore termostatico per doccia esterno, versione completa di colonna telescopica, soffione e doccetta idromassaggio.

Thermostatic shower mixer with telescopic column, shower head and massage handshower.



30 N398 N5
Set saliscendi 70-22 con doccia Silla 3g. testa d.12 cm flex satilux.

Sliding rail set 70-22 with Silla 3-jet shower Ø 12 cm, satilux flex.



30NN8785
Kit supporto doccetta e flessibile con presa acqua.

Shower set composed of holder, handshower, flex and intake of water.



30NN8630
Soffione Ø200 mm con braccio 350 mm.

Shower head Ø200 mm with inlet arm 350 mm.



30NN8650
Soffione 200x200 mm con braccio 350 mm.

Shower head 200x200 mm with inlet arm 350 mm.



30NN8786
Kit supporto doccetta e flessibile con presa acqua.

Shower set composed of holder, handshower, flex and intake of water.



30CR8598
Kit Shut-Off quadro in ottone cromato con flessibile antitorsione 120 cm in PVC grigio metallizzato con rubinetto e supporto integrato.

Chromed brass square Shut-off kit with 120 cm grey metallized PVC flexible hose antitwist tap and integrated wall bracket.

DISPONIBILI NELLE FINITURE DELLA COLLEZIONE PRIMAVERA

AVAILABLE IN THE PRIMAVERA COLLECTION FINISHINGS



30CR8592
Kit Shut-Off tondo in ottone cromato con flessibile antitorsione 120 cm in PVC grigio metallizzato con rubinetto e supporto integrato.

Chromed brass round Shut-off kit with 120 cm grey metallized PVC flexible hose antitwist tap and integrated wall bracket.



30CH8595
Miscelatore a parete con doccetta igienica, flex cm 120.

Wall mixer with shut-off, flex cm 120.

DISPONIBILI NELLE FINITURE DELLA COLLEZIONE PRIMAVERA

AVAILABLE IN THE PRIMAVERA COLLECTION FINISHINGS



30CH8590
Miscelatore a parete con doccetta igienica, flex cm 120.

Wall mixer with shut-off, flex cm 120.

EXPERIENCE
FIORE

WELLNESS

THE BEST
SOLUTION
FOR YOUR
BATHROOM

PLACCA WC FLUSH PLATES



30OS8585
Placca WC con pulsanti
tondi.
*Flush plate with two round
buttons.*

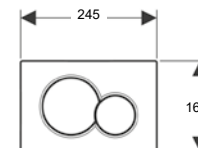

ORO
SCURO

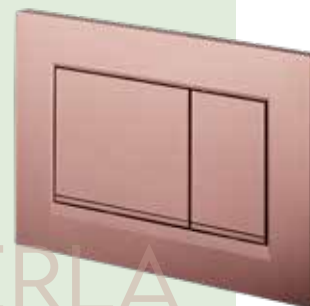

30PR8586
Placca WC con pulsanti
quadrati.
*Flush plate with two square
buttons.*

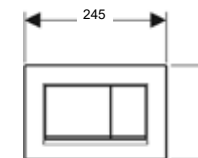

PERLA
ROSA

DISPONIBILE NELLE FINITURE
DELLA COLLEZIONE PRIMAVERA

AVAILABLE IN THE PRIMAVERA
COLLECTION FINISHINGS

BOX DOCCIA SHOWER BOX



DISPONIBILE NELLE FINITURE
DELLA COLLEZIONE PRIMAVERA

AVAILABLE IN THE PRIMAVERA
COLLECTION FINISHINGS



30CHB120	
X1	X2
118,5 - 119,5 cm	MAX 120 cm

30CHB140	
X1	X2
138,5-139,5 cm	MAX 120 cm

30CHB160	
X1	X2
138,5-139,5 cm	MAX 120 cm

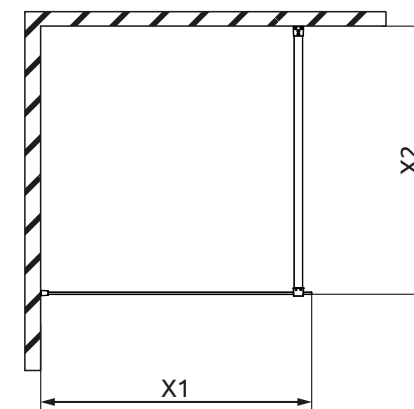

EXPERIENCE FIORE KITCHEN

THE BEST
SOLUTION
FOR YOUR
KITCHEN



^
FIRENZE
306CR9215 / NN / AA
Miscelatore lavello
One hole sink mixer



< VENEZIA
306CR9211
Miscelatore lavello
One hole sink mixer



MILANO >
306CR9218
Miscelatore lavello con doccetta estraibile
One hole sink mixer with pull-out spray



TORINO >
306CR9202
Miscelatore lavello con doccetta estraibile
One hole sink mixer with pull-out spray



^
TAORMINA
306CR9220 / NN / AA
Miscelatore lavello con doccetta estraibile
One hole sink mixer with pull-out spray



^
GENOVA
 306CR9219 / NN
 Miscelatore lavello con doccetta estraibile
One hole sink mixer with pull-out spray



<
VENEZIA
 306NN9211
 Miscelatore lavello
One hole sink mixer



<
CATANIA
 306CR9403
 Miscelatore lavello con doccetta estraibile
One hole sink mixer with pull-out spray

PRODUCT SELECTION



**306CR9219
GENOVA**
Miscelatore lavello con
doccetta estraibile
*One hole sink mixer with
pull-out spray*



**306CR9217
BOLOGNA**
Miscelatore lavello
One hole sink mixer



**306CR9208
TRIESTE**
Miscelatore lavello
One hole sink mixer

DISPONIBILE NELLE FINITURE
DELLA COLLEZIONE PRIMAVERA

AVAILABLE IN THE PRIMAVERA
COLLECTION FINISHINGS



81CR4310
Miscelatore lavello
One hole sink mixer



81CR4318
Miscelatore lavello
One hole sink mixer



75CR4395
Miscelatore lavello con doccetta
estraibile
*One hole sink mixer with
pull-out spray*



44CR5455
Miscelatore lavello
One hole sink mixer



44CR5480
Miscelatore lavello
One hole sink mixer



44CR5461
Miscelatore lavello
One hole sink mixer



^
**306RA9208
TRIESTE**
Miscelatore lavello
One hole sink mixer

DISPONIBILE NELLE FINITURE
DELLA COLLEZIONE PRIMAVERA

AVAILABLE IN THE PRIMAVERA
COLLECTION FINISHINGS

Ordini

Tutti gli ordini si intendono accettati dopo conferma da parte della Fiore Rubinetterie srl e non impegnano il produttore alla consegna anche parziale di quanto ordinato.

Prezzi

I prezzi sono soggetti a variazioni e non sono impegnativi senza conferma.

Spedizioni

Vengono sempre effettuate in porto assegnato, salvo speciali accordi in contrario. La merce viaggia a totale rischio e pericolo del committente, anche se venduta franco destino. La società Fiore Rubinetterie srl si ritiene sollevata da ogni responsabilità in merito ad eventuali ammanchi, avarie o ritardi.

Le spedizioni vengono effettuate con il mezzo disponibile al momento e le indicazioni del Cliente hanno valore di semplice raccomandazione.

Termini di consegna

Sono soltanto approssimativi e non danno diritto al committente di annullare l'ordine o reclamare danni di qualsiasi natura per ritardi derivanti da incidenti di fabbricazione o di forza maggiore.

Imballi

Gli imballi sono fatturati al puro costo e non si accettano di ritorno. Confezioni e imballi possono subire variazioni o modifiche senza preavviso.

Trasporto

Addebito in fattura.

Reclami

I reclami sono ritenuti validi solo se presentati entro 8 giorni dal ricevimento della merce, con raccomandata. I dati contenuti nel presente catalogo possono subire variazioni o modifiche senza alcun preavviso. I dati eventualmente riscontrati difformi dal Cliente non possono essere motivo di contestazione della fornitura.

Responsabilità

La responsabilità di Fiore Rubinetterie srl circa la qualità dei materiali si limita all'accettazione del reso, franco nostro magazzino, e alla eventuale sostituzione di pezzi che venissero riscontrati difettosi, senza perciò essere tenuti ad alcun indennizzo. La società non accetta alcuna responsabilità per difetti che risultano da eventuale manomissione dei materiali forniti.

Pagamenti

Le condizioni sono quelle indicate nelle offerte e nelle fatture proforma esono impegnative. Trascorse le scadenze convenute, saranno conteggiati gli interessi di mora. Il ritardo nel pagamento autorizza la Fiore Rubinetterie srl a sospendere senza alcun preavviso le forniture in corso.

Riserva di proprietà
La Fiore Rubinetterie srl si riserva la proprietà sulle merci fintanto che l'importo non viene totalmente pagato.

Contestazioni

Orders

All orders are considered as accepted only after the order confirmation issued by Fiore Rubinetterie srl and they are not binding for any partial/total delivery by Fiore Rubinetterie srl.

Prices

Before the order confirmation the prices can be modified.

Deliveries

Deliveries are intended ex-factory, except for different agreements between Fiore Rubinetterie srl and the customers. Fiore Rubinetterie srl is not responsible for any delay or any kind of damage or missing of the goods during the transport, even in case of free destination delivery.

Deliveries will be effected through the forwarding agent available at that moment and the requests of the customer are intended only as recommendations.

Delivery terms

Delivery terms are intended as indicative and do not authorize the cancellation of the order by the customer, or any refund request by the customer for any delay due to reasons, which do not depend from Fiore Rubinetterie srl, such as manufacture accidents or force majeure.

Packaging

The packing has to be paid and can not be returned by the customer.

The packaging style can be modified without any notice.

Transport cost

The transport cost is calculated on the invoice.

Claims

Claims are valid only within 8 days upon receipt of the goods and must be communicated by registered letter. All details shown in the present catalogue can be modified without any notice. Different details stated by the customer cannot be object of claim.

Liability

Fiore Rubinetterie srl is responsible for the quality of the goods and will only replace defective pieces returned to the customer's charge. No further refund will be effected. Fiore Rubinetterie srl is not responsible for any damage caused to the product after the delivery.

Payments

The payment conditions are stated in our offers and proforma invoices and they are binding. After the maturity date interest on delayed payment will be calculated. Any delay of payment allows Fiore Rubinetterie srl to stop the deliveries without any notice.

Right of ownership

Fiore Rubinetterie srl reserves the right of ownership on the goods until their whole amount is totally paid.

Dispute

For any dispute the parties refer to the Court of Novara.

Commandes

Toutes les commandes sont considérées comme acceptées seulement après la confirmation par Fiore Rubinetterie srl et n'engagent pas notre société à leur livraison, même si partielle.

Prix

Les prix peuvent changer et ils ne sont pas valables sans notre confirmation.

Expeditions

Toutes les expéditions sont effectuées en départ usine sauf accords spéciaux différents. Le transport de la marchandise, même si les frais sont à charge de Fiore Rubinetterie srl, reste à risques et périls du commettant; manques et dommages ou retards éventuels ne peuvent pas être imputés à Fiore Rubinetterie srl. Les expéditions sont effectuées par le moyen disponible et les indications du Client seront considérées seulement comme recommandations.

Délais de livraison

Les délais de livraison sont seulement indicatifs et ils ne donnent pas le droit au commettant d'annuler la commande ou de demander des remboursements de n'importe quelle nature pour retards causés par problèmes de fabrication ou de force majeure.

Emballages

Les emballages sont facturés au prix de revient et ils ne sont pas acceptés de retour. Ils peuvent être changés ou modifiés sans préavis.

Transport

Il est débité sur la facture.

Réclamations

Elles sont valables seulement si effectuées dans 8 jours de la réception de la marchandise par lettre recommandée.

Les données indiquées sur le présent catalogue peuvent être modifiées sans préavis.

Données relevées différentes par le client ne peuvent pas être la cause d'une contestation de la fourniture.

Responsabilité

La responsabilité de Fiore Rubinetterie srl sur la qualité des matériaux est limitée à l'acceptation des pièces de retour, franco notre magasin, et à leur remplacement, dans le cas où elles sont défectueuses, sans donc être obligés à aucun remboursement.

La société Fiore Rubinetterie srl ne peut pas être considérée responsable pour défauts causés par une altération éventuelle des matériaux fournis par elle.

Payement

Les conditions sont celles indiquées sur nos offres et factures proforma et elles sont contraignantes.

Après les échéances convenues, on calculera les intérêts moratoires. Le retard de payement autorise la société Fiore Rubinetterie srl à suspendre sans préavis les fournitures en cours.

Réserve de propriété

La société Fiore Rubinetterie srl se réserve la propriété jusqu'au moment où la marchandise n'est pas totalement payée.

Litiges

Pour tout litige, les parties reconnaissent la compétence du

Tribunal de Novara.



Catalogues



Pictures



Company presentations



Technical drawings



Company video



Installation instructions



fiore.it



Certificazioni

Fiore Rubinetterie s.r.l
28021 Borgomanero (NO) Italia
Via Maggiate 69/C

Tel. +39 0322 840711

fiore.it
fiore@fiore.it

 Fiore Rubinetterie

 fiorerubinetterie

