



EXTERIOR LIGHTING

**Il fascino di un tempo  
la bellezza contemporanea**

ancient charm,  
contemporary beauty



**Engi s.r.l. è un'azienda italiana leader nel settore dell'illuminotecnica, specializzata nell'ideazione, progettazione, sviluppo e realizzazione di prodotti a led.**

**La produzione viene eseguita interamente dall'azienda, che si trova nel Nord Est dell'Italia, territorio conosciuto in tutto il mondo per la bellezza, i sapori, la storia, la produzione e l'innovazione.**

**Tutti i nostri articoli sono costruiti a mano con materiali ecocompatibili e riciclabili, combinando la tradizione con la tecnologia a led e la lavorazione di metalli, vetro o plastica.**

**Ogni prodotto è unico e diverso dagli altri perché la filosofia dell'azienda è quella di realizzare per ogni cliente degli apparecchi di illuminazione che con la loro luce calda e avvolgente gli ricordino il nostro territorio, i suoi abitanti, la storia, i sapori e le emozioni del Veneto e dell'Italia.**

Engi srl is a leading Italian Company in the lighting field; Engi srl is specialized in designing, developing and manufacturing of lighting products.

All our products are manufactured by hand in our factory based in the North Eastern region of Italy. The Veneto region well known worldwide for its historical beauty, rich sense of style, and innovative Italian design.

We combine tradition with technology incorporating various materials including glass, metals, and plastics with recyclability and eco-friendly processing.

Each product is unique and designed for the individual customer. Our philosophy is to make lighting products which inspire our customers to recall our country, our people and our history. ENGI - enchanting lighting solutions from the Italian heart of Veneto to you.



**Engi s.r.l. si trova a Rosà, in Veneto e negli ultimi anni si è fatta conoscere a livello internazionale grazie alla partecipazione a diverse fiere ed eventi. Creatività ed esperienza permettono all'azienda di sviluppare nuovi prodotti utilizzando la tecnologia a led e di fornire un prodotto completamente "Made in Italy".**

Engi s.r.l. is based in Rosà, in the North East of Italy; in a short period it has become a well known international Company, participating in worldwide fairs and exhibitions. Skills in lighting and creativity contribute to development of new lighting solutions where LED and design are combined together to offer a strictly "Made in Italy" product.

© Engi srl - Made in Italy

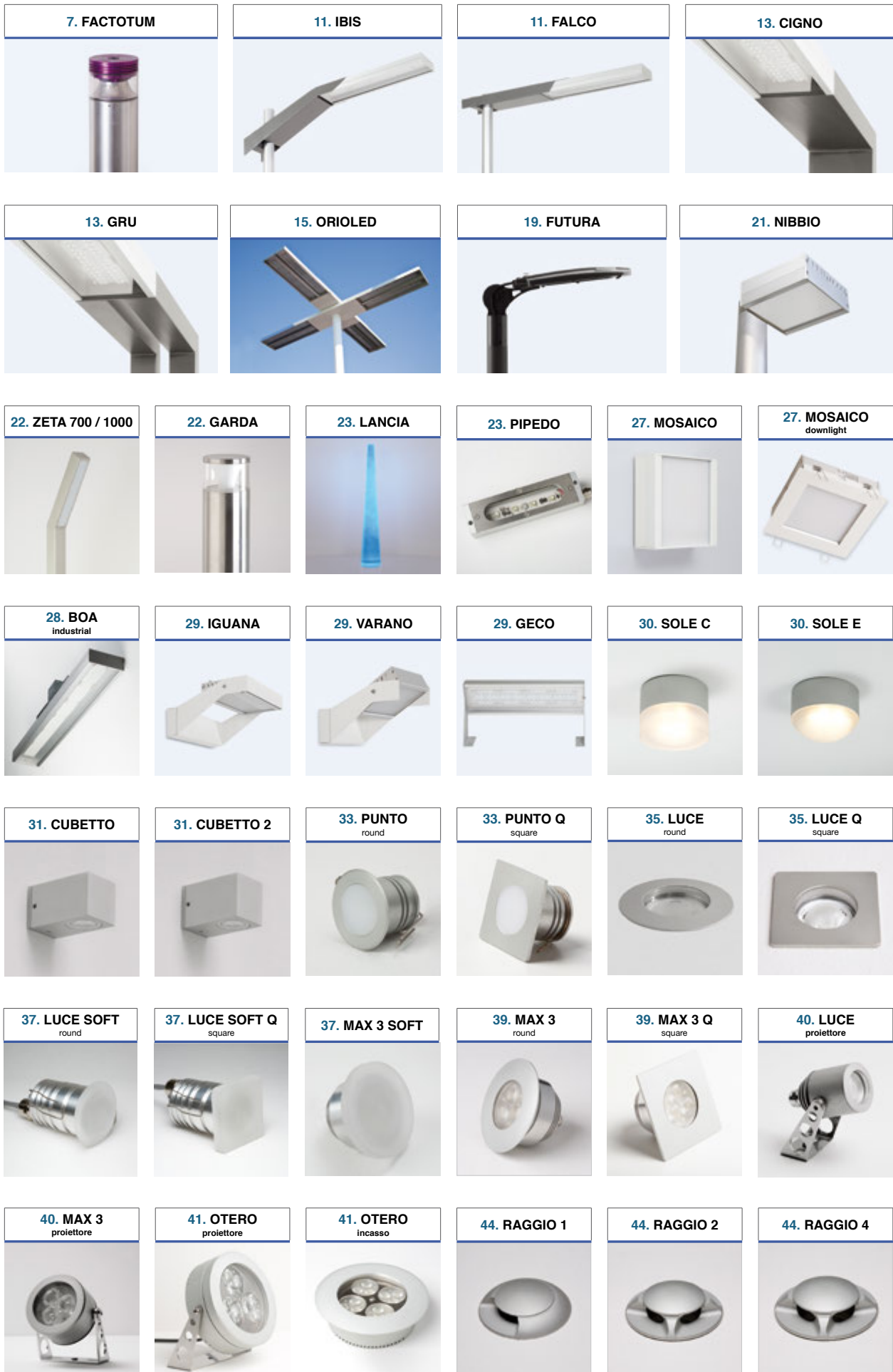

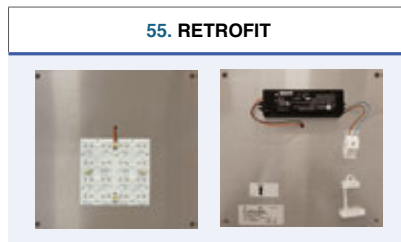
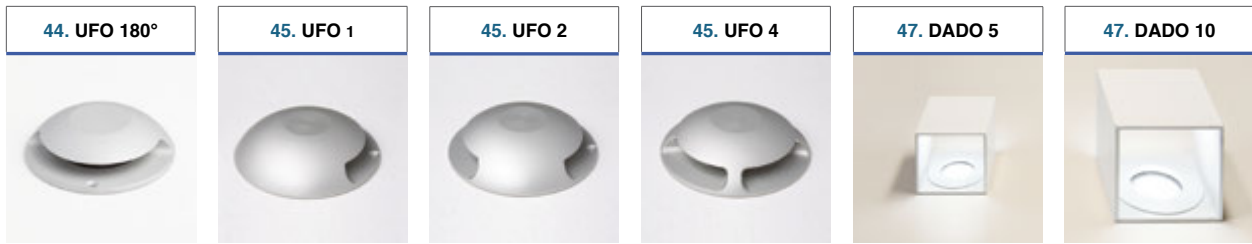



MARIVS CAPRA  
GABRIELIS F

## FACTOTUM®

230V – 50Hz – Classe I – IP67 - 30000J



**Bollard retrattile in acciaio inox AISI316. Carrabile quando chiuso, antiurto quando aperto.**

**Adatto per utilizzo in giardini, parcheggi e piazze e negli ambienti più vari, per atmosfera, umidità e temperatura, dal mare alla montagna.**

**Movimento elettromeccanico, sprinkler per irrigazione, illuminazione a LED e la possibilità di integrare i più svariati sensori IoT fanno di Factotum un prodotto multifunzionale estremamente versatile.**

Retractable bollard in AISI316 stainless steel. Drive-over when closed, shock-proof when open.

Suitable for use in gardens, parking lots and squares. Installable in the most varied environments, atmospheres, humidity and temperature conditions, from the sea to the mountains.

Electromechanical movement, irrigation sprinklers, LED lighting, car bollard. Factotum is an extremely versatile multifunctional product that give the possibility to integrate the most varied IoT sensors.

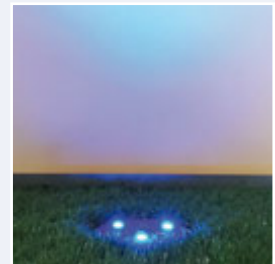
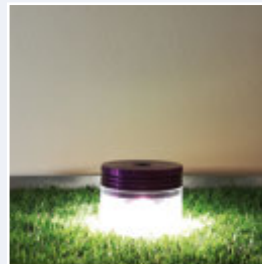

### Protocolli e servizi integrabili / Integrated services/protocols

illuminazione up / Up-lighting	3x1W LED
illuminazione down / Down-lighting	4x3W LED
LED monocromatici o RGB / Monochrome LEDs or RGB	
Movimentazione elettrica regolabile / Adjustable electric movement	
Irrigazione con sprinkler - vari getti / Sprinkler irrigation - various jets	
Segnale video TV-CC / TV-CC video signal	
Segnale audio per la diffusione sonora / Audio signal for sound diffusion	
Controllo accessi / Access control	
Sensori di sicurezza – allarme / Security sensors – alarm	
Hotspot WI-FI / WI-FI hotspot	
Comunicazione – Internet of Things con la possibilità di inserire sensori IoT Communication - Internet of Things with the possibility of inserting IoT sensors	
Dimensione esterna / Outer dimension	Φ130x500mm
Dimensione incasso / Inner dimension	Φ185x750mm
Quadro di comando di dimensione variabile secondo le opzioni scelte. Different control cabinets with dimension according to options	

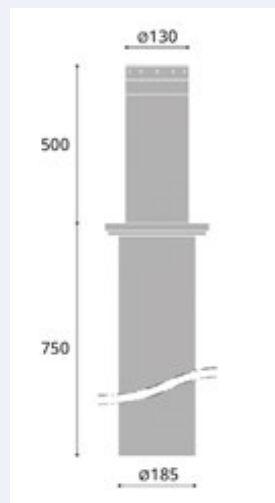

Quadro di comando escluso.  
Control cabinet excluded.

# EXTERIOR LIGHTING

## FACTOTUM®

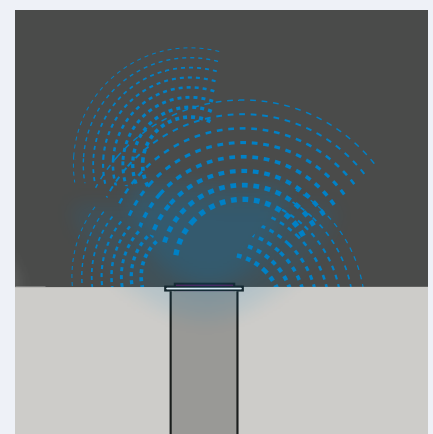
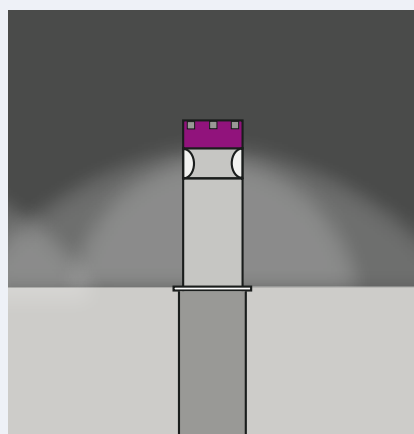
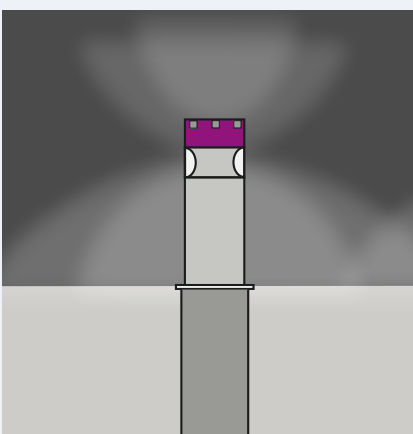
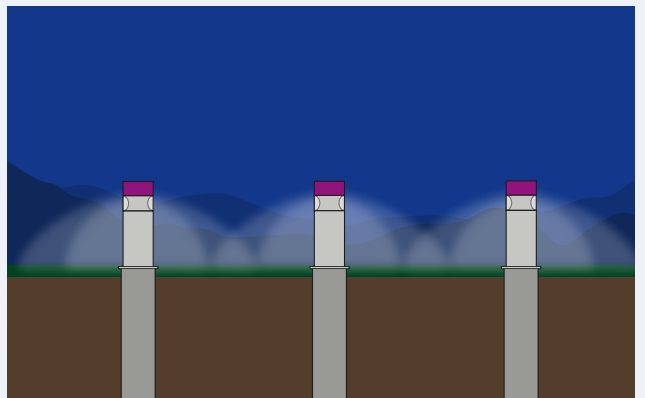
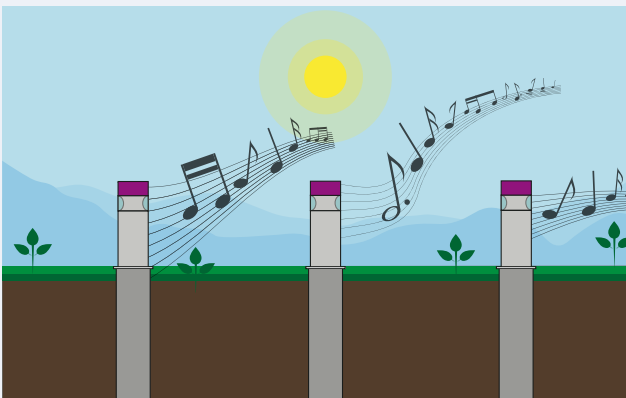
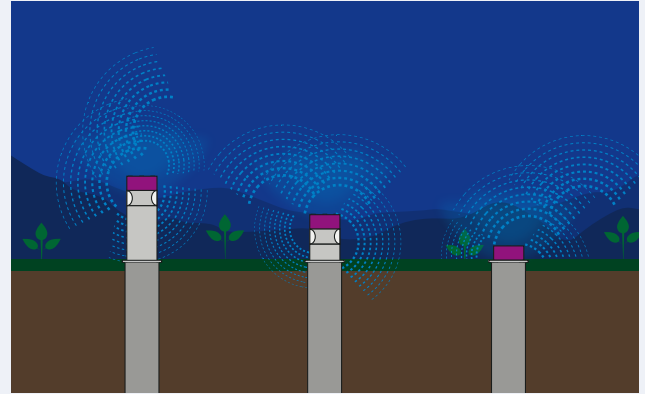
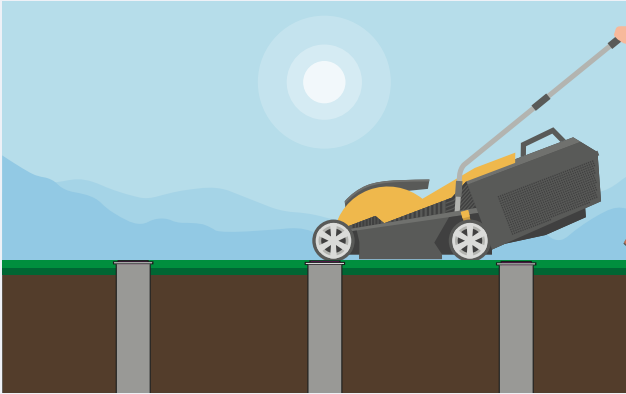



# STREET LIGHTING



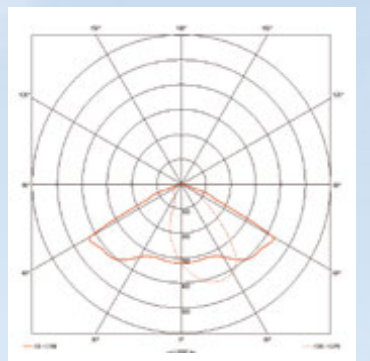

## IBIS



**Apparecchio a led per illuminazione di strade e piste ciclo-pedonali, piazze, parchi e spazi pubblici. Distribuzione fotometrica stradale. Installazione testapalo per pali cilindrici  $\varnothing$  60mm o rettangolari 150x50mm. Corpo in alluminio estruso, anodizzato colore grigio argento, attacco inclinato in acciaio zincato e verniciato grigio 900 Sablé. Diffusore piano trasparente. Alimentatore incluso nell'apparecchio.**

Lighting fixture with led technology, suitable for streets, pedestrian and cycle tracks, squares, parks and public areas in general. Street lighting distribution. Top pole or lateral installation for cylindrical or rectangular poles. Body in extruded anodized aluminium, linear bracket in galvanized steel, painted in grey 900 sablé (anthracite). Transparent flat diffuser. Driver included.

IBIS	ENIB01
LED Colour	White 3950K
LED Type	Rebel - Power Led
LED Number	24/36/48/60/72
LED Power	2W - 700mA
Total Power	50/75/100/125/150W
Input	230Vac
Weight	9 kg
Lens	Street Lighting
Insulation Class	I - II
IP Code	<b>IP65</b>
Dimensions	see drawing
Body	AL Anodized and painted
Diffuser	Clear PMMA

Notes: driver included. On request double bracket - Dimmable ballast on request

### Product types

Product type	LED Number	LED Power	Total Power
ENIB0124	24	700mA	5500 lm 50W
ENIB0136	36	700mA	8250 lm 75W
ENIB0148	48	700mA	11000 lm 100W
ENIB0160	60	700mA	13750 lm 125W
ENIB0172	72	700mA	16500 lm 150W

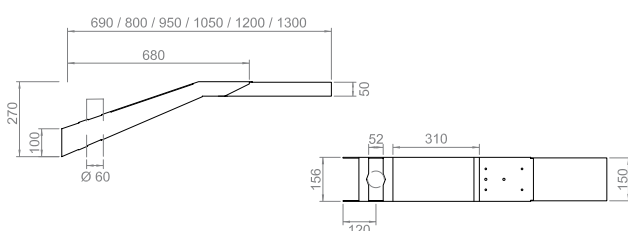

## FALCO



**Apparecchio a led per illuminazione di strade e piste ciclo-pedonali, piazze, parchi e spazi pubblici. Distribuzione fotometrica stradale. Installazione laterale o testapalo per pali cilindrici o rettangolari 150x50mm. Corpo in alluminio estruso, anodizzato colore grigio, attacco lineare in acciaio zincato e verniciato grigio argento 900 Sablé. Alimentatore incluso nell'apparecchio.**

Lighting fixture with led technology, suitable for streets, pedestrian and cycle tracks, squares, parks and public areas in general. Street lighting distribution. Top pole or lateral installation for cylindrical and rectangular poles. Body in extruded anodized aluminium, linear bracket in galvanized steel, painted in grey 900 sablé (anthracite). Driver included.

FALCO	ENFA01
LED Colour	White 3950K
LED Type	Power Led
LED Number	24/36/48/60/72
LED Power	2W - 700mA
Total Power	50/75/100/125/150W
Input	230Vac
Weight	9 kg
Lens	Street Lighting
Insulation Class	I - II
IP Code	
Dimensions	see drawing
Body	AL Anodized and painted
Diffuser	Clear PMMA

Notes: driver included. On request double bracket - Dimmable ballast on request

### Product types

Product type	LED Number	LED Power	Total Power
ENFA0124	24	700mA	5500 lm 50W
ENFA0136	36	700mA	8250 lm 75W
ENFA0148	48	700mA	11000 lm 100W
ENFA0160	60	700mA	13750 lm 125W
ENFA0172	72	700mA	16500 lm 150W

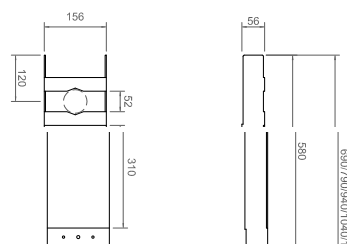

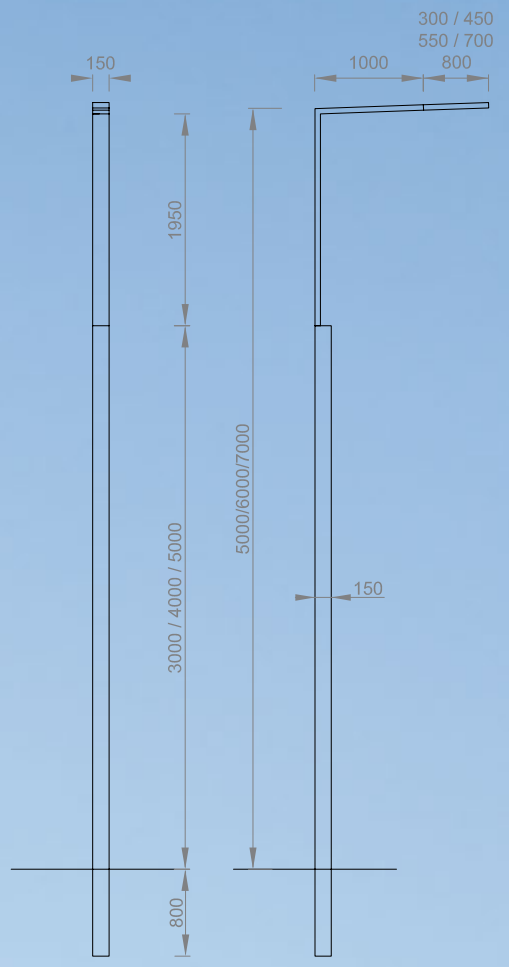

## CIGNO



## GRU



**Apparecchio a led per illuminazione di strade e piste ciclo-pedonali, piazze, parchi e spazi pubblici. Distribuzione fotometrica stradale. Installazione testapalo per palo rettangolare o quadrato.**

**Corpo in alluminio estruso, braccio a “L” in acciaio zincato e verniciato grigio argento 900 Sablé.**

**Alimentatore inserito nel palo.**

Lighting fixture with led technology, suitable for streets, pedestrian and cycle tracks, squares, parks and public areas in general. Street lighting distribution, top pole installation for rectangular or square poles. Body in extruded anodized aluminium, “L” bracket in galvanized steel, painted in grey 900 sablé (anthracite). Driver included on pole.

**Apparecchio a led per illuminazione di strade e piste ciclo-pedonali, piazze, parchi e spazi pubblici. Distribuzione fotometrica stradale. Installazione testapalo per palo rettangolare o quadrato. Corpo in alluminio estruso, anodizzato colore grigio argento con due montanti separati rettangolari 60x50mm a “L” rovesciata in acciaio zincato e verniciato grigio 900 Sablé. Alimentatore inserito nel palo.**

**Corpo in alluminio estruso, anodizzato colore grigio argento con due montanti separati rettangolari 60x50mm a “L” rovesciata in acciaio zincato e verniciato grigio 900 Sablé. Alimentatore inserito nel palo.**

Lighting fixture with led technology, suitable for streets, pedestrian and cycle tracks, squares, parks and public areas in general. Street lighting distribution, top pole installation for rectangular or square poles. Body in extruded anodized aluminium. “L” bracket composed by 2 rectangular profiles 60x50mm in galvanized steel, painted in grey 900 sablé (anthracite). Driver included on pole.

CIGNO	ENCI01
LED Colour	White 3950K
LED Type	Power Led
LED Number	24/36/48/60/72
LED Power	2W - 700mA
Total Power	50/75/100/125/150W
Input	230Vac
Weight	9 kg
Lens	Street Lighting
Insulation Class	I - II
IP Code	<b>IP65</b>
Dimensions	see drawing
Body	AL Anodized and painted
Diffuser	Clear PMMA

Notes: driver included. On request double bracket - Dimmable ballast on request

Product types				
ENCI0124	24	700mA	5500 lm	50W
ENCI0136	36	700mA	8250 lm	75W
ENCI0148	48	700mA	11000 lm	100W
ENCI0160	60	700mA	13750 lm	125W
ENCI0172	72	700mA	16500 lm	150W

GRU	ENGR01
LED Colour	White 3950K
LED Type	Power Led
LED Number	24/36/48/60/72
LED Power	2W - 700mA
Total Power	50/75/100/125/150W
Input	230Vac
Weight	9 kg
Lens	Street Lighting
Insulation Class	I - II
IP Code	<b>IP65</b>
Dimensions	see drawing
Body	AL Anodized and painted
Diffuser	Clear PMMA

Notes: driver included. On request double bracket - Dimmable ballast on request

Product types				
ENGR0124	24	700mA	5500 lm	50W
ENGR0136	36	700mA	8250 lm	75W
ENGR0148	48	700mA	11000 lm	100W
ENGR0160	60	700mA	13750 lm	125W
ENGR0172	72	700mA	16500 lm	150W



## ORIOLED



**Nuovo apparecchio a led per illuminazione di parcheggi, rotonde, grandi aree e piazze. Quattro bracci a 90° da 300W. Distribuzione fotometrica quadrata al suolo. Installazione su testapalo Ø 90 mm. Corpo in alluminio estruso, anodizzato colore grigio, attacco a palo in acciaio zincato verniciato bianco RAL 9010.**

New lighting luminaire with led technology suitable for parks, big areas, squares and public areas in general. It is supplied with four brackets at 90°, 300W. Top pole installation Ø 90 mm. Body in extruded anodized aluminium, grey colour, bracket in galvanized steel painted in white RAL 9010.

ORIOLED	400	600	800	1000	1200
LED Number	4x48 LEDs	4x72 LEDs	4x96 LEDs	4x120 LEDs	4x144 LEDs
LED Power	2W – 230lm	2W – 230lm	2W – 230lm	2W – 230lm	2W – 230lm
Total Power	400W	600W	800W	1000W	1200W
Optic	Asymmetric lenses	Asymmetric lenses	Asymmetric lenses	Asymmetric lenses	Asymmetric lenses
LED Colour	White 3950K	White 3950K	White 3950K	White 3950K	White 3950K
CRI	>70	>70	>70	>70	>70
Input	230Vac	230Vac	230Vac	230Vac	230Vac
Insulation	Class I-II	Class I-II	Class I-II	Class I-II	Class I-II
IP Rating	IP65	IP65	IP65	IP65	IP65
Dimensions	<b>1450x1450x120mm</b>	<b>1750x1750x120mm</b>	<b>2100x2100x120mm</b>	<b>2200x2200x120mm</b>	<b>2400x2400x120mm</b>
Body	painted steel	painted steel	painted steel	painted steel	painted steel
Diffuser	Clear PMMA	Clear PMMA	Clear PMMA	Clear PMMA	Clear PMMA

Notes: driver included in the luminaire. Dimmable ballast on request. Double bracket-half power version available on request.

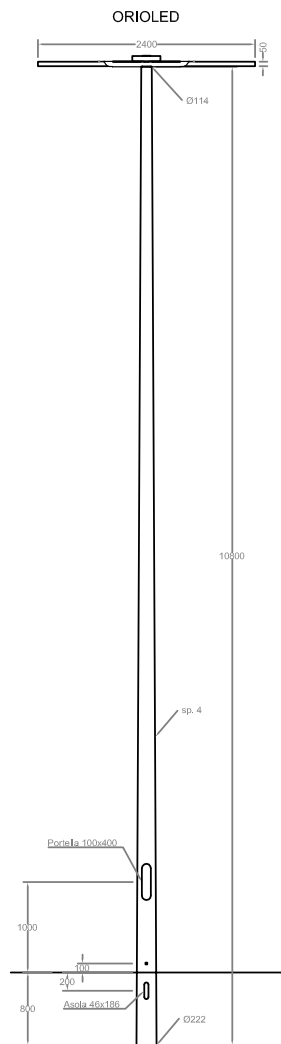

**Altezza palo: 10m f.t.**  
**PALO EN 10.800/OR - CONICO**  
 - base 222mm - spessore 4mm  
 - sommità 114mm - spessore 4mm  
 - codolo 90x120mm  
 - peso palo 186kg  
 - verniciatura RAL9003 su richiesta

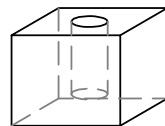

**DIMENSIONI PLINTO**  
 Larghezza = 1200mm  
 Altezza = 1000mm  
 Diamet. foro = 400mm  
 Profond. foro = 800mm

**LAVORAZIONI CODOLO**

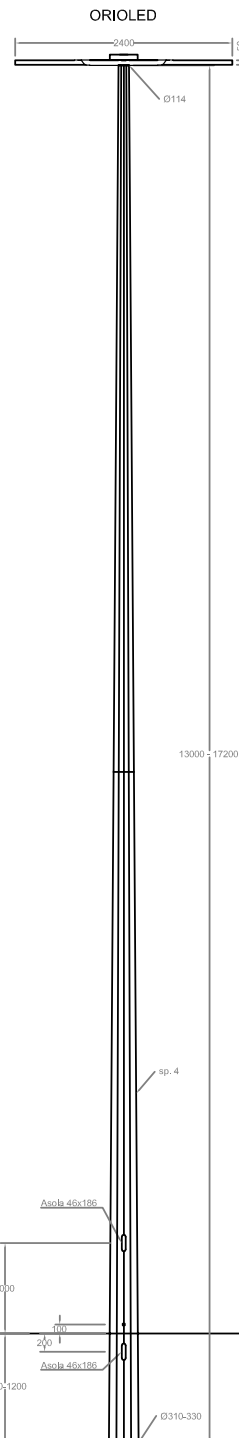
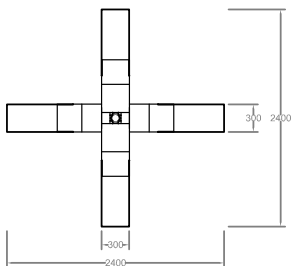

**Altezza palo: 12m f.t.**  
**PALO EN 13.000/ORP - POLIGONALE 2tronchi**  
 - base 310mm - spessore 4mm  
 - sommità 90mm - spessore 4mm  
 - peso palo 271kg  
 - verniciatura RAL9003 su richiesta

**Altezza palo: 13m f.t.**  
**PALO EN 14.000/ORP - POLIGONALE 2tronchi**  
 - base 330mm - spessore 4mm  
 - sommità 90mm - spessore 4mm  
 - peso palo 312kg  
 - verniciatura RAL9003 su richiesta

**Altezza palo: 14m f.t.**  
**PALO EN 15.000/ORP - POLIGONALE 2tronchi**  
 - base 330mm - spessore 4mm  
 - sommità 90mm - spessore 4mm  
 - peso palo 330kg  
 - verniciatura RAL9003 su richiesta

**Altezza palo: 15m f.t.**  
**PALO EN 16.200/ORP - POLIGONALE 2tronchi**  
 - base 330mm - spessore 4mm  
 - sommità 90mm - spessore 4mm  
 - peso palo 354kg  
 - verniciatura RAL9003 su richiesta

**Altezza palo: 16m f.t.**  
**PALO EN 17.200/ORP - POLIGONALE 2tronchi**  
 - base 330mm - spessore 4mm  
 - sommità 90mm - spessore 4mm  
 - peso palo 375kg  
 - verniciatura RAL9003 su richiesta

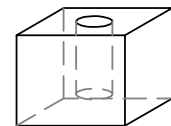

**DIMENSIONI PLINTO**  
 Da calcolare in base a relazione geologica

**LAVORAZIONI CODOLO**

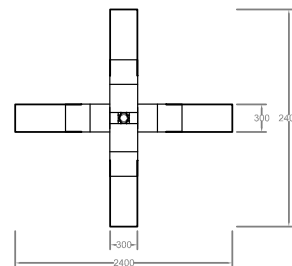
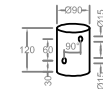



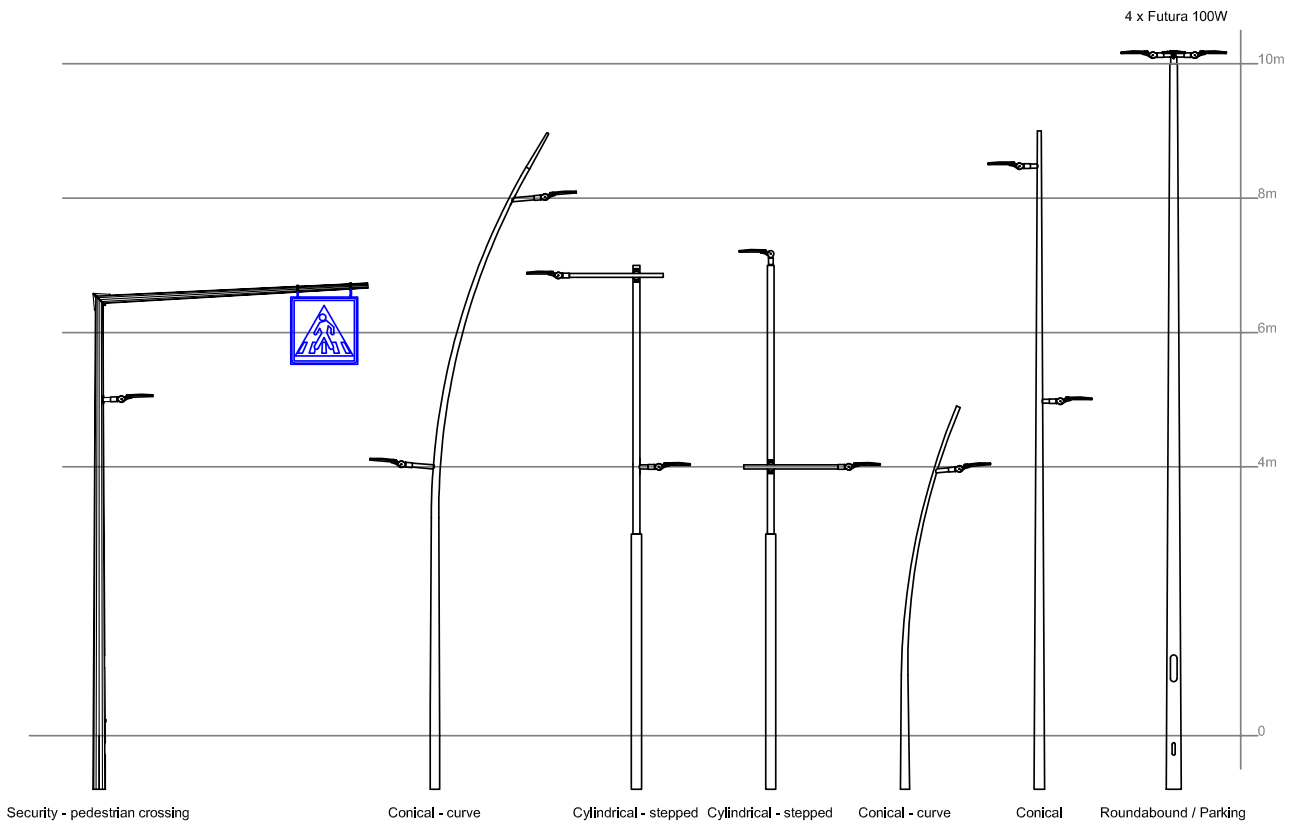
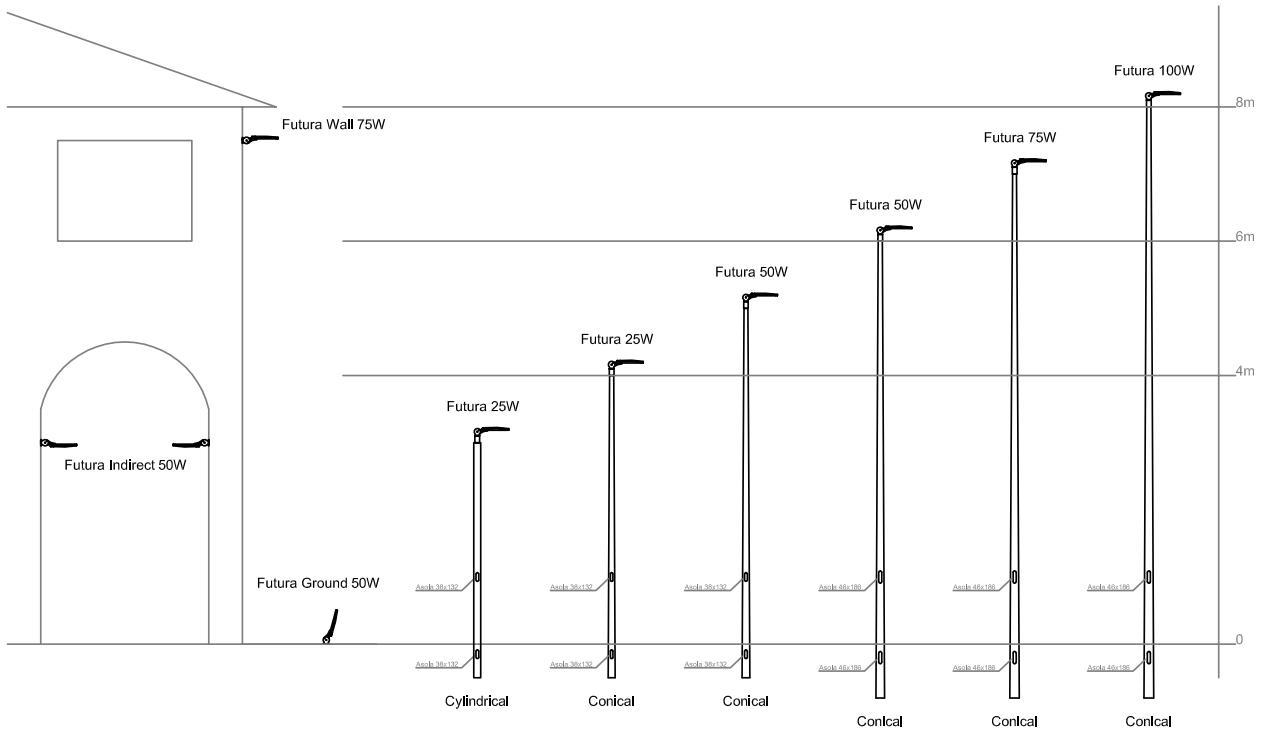

Option: luminous spike "Lancia" see pag.23

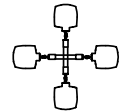



## FUTURA

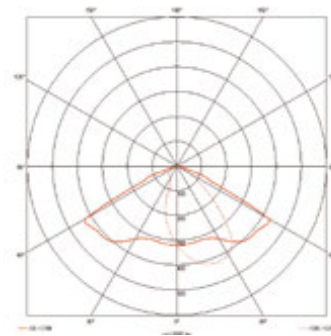

Apparecchio a led per illuminazione di strade e piste ciclo-pedonali, piazze, parchi e spazi pubblici. Installazione testapalo laterale, o con attacco a parete. Corpo in alluminio pressofuso.

Cornice di chiusura in acciaio zincato e verniciato come il corpo. Diffusore piano trasparente.

Lighting fixture with led technology, suitable for streets, pedestrian and cycle tracks, squares, parks and public areas in general.

Top pole lateral or wall installation. Body in die cast aluminium, Noir Decor finishing. Steel closure finishin as the body. Transparent flat diffuser.

FUTURA	ENFU01
LED Colour	White 3950K
LED Type	Power Led
LED Number	12/24/36/48/60
LED Power	2W - 700mA
Total Power	25/50/75/100/125 W
Input	700mA driver on pole
Weight	7 kg
Lens	Street Lighting
Insulation Class	I - II
IP Code	<b>IP65</b>
Dimensions	see drawing
Body	Noir decor finishing
Diffuser	Clear

Notes: driver included, on pole. Dimmable on request

Product types				
ENC10112	12	700mA	5500 lm	25W
ENC10124	24	700mA	5500 lm	50W
ENC10136	36	700mA	8250 lm	75W
ENC10148	48	700mA	11000 lm	100W
FOTOVOLT	12	12Vdc	5500 lm	150W

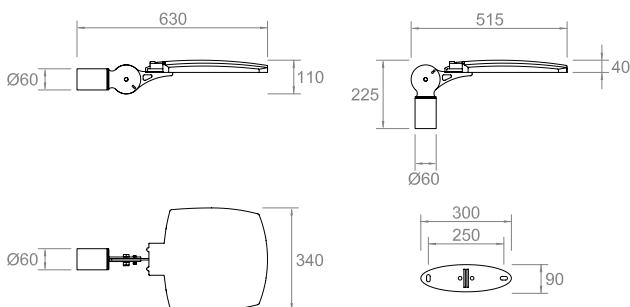



## NIBBIO



**Apparecchio a led per illuminazione di piste ciclo-pedonali, giardini, parchi e spazi pubblici. Installazione testapalo. Corpo in alluminio anodizzato colore grigio o verniciato a richiesta. Attacco in acciaio zincato caldo verniciato per pali da 2-3m.**

Lighting fixture with led technology, suitable for pedestrian and cycle tracks, gardens, parks and public areas in general. Top pole installation. Body in anodized aluminium grey colour or painted, bracket in galvanized painted steel for 2-3m poles.

NIBBIO	ENNI0122
LED Colour	White 3950K
LED Type	Power Led
LED Power	20W
Total Power	20 W
Input	230Vac
Weight	0,5 kg
Insulation Class	I - II
IP Code	<b>IP65</b>
Dimensions	150x150x50
Body	AL. anodized painted on request
Diffuser	opal PMMA

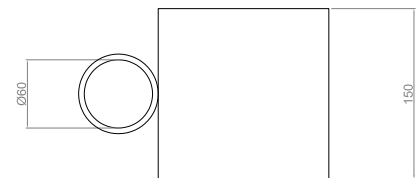
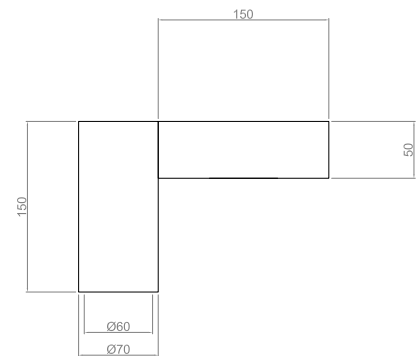

## ZETA 700 e ZETA 1000



**Colonnina a led per illuminazione esterna, adatto in applicazioni come giardini, marciapiedi, aree pedonali, parchi. Corpo in acciaio inox 316L spazzolato, completo di diffusore in materiale plastico opalizzato.**

Lighting column with led lighting source ideal for paths, gardens and squares. Body in stainless steel. IP54, Complete with PPMA clear diffuser to avoid glare.

ZETA	EN5000	EN5001	EN5005	EN5006
LED Colour	White	White	White	White
LED Number	6	-	6	-
TOTAL Power	7,2W	16W	7,2W	16W
Input	24Vdc	230Vac	24Vdc	230Vac
Weight	1,2 kg	1,2 kg	1,5 kg	1,5 kg
Insulation Class	III	I	III	I
IP Code	<b>IP54</b>	<b>IP54</b>	<b>IP54</b>	<b>IP54</b>
Dimensions	<b>720x60 mm</b>	<b>720x60 mm</b>	<b>1100x60 mm</b>	<b>1100x60 mm</b>
Body finishing	Stainless steel	Stainless steel	Stainless steel	Stainless steel
Diffuser finishing	Matt	Matt	Matt	Matt

## GARDA



**Colonnina a led per illuminazione esterna, adatto in applicazioni in giardini, marciapiedi, aree pedonali, parchi. Corpo in acciaio inox satinato o verniciato. Completo di diffusore in PPMA trasparente con convogliatore di flusso anti-abbagliamento.**

Lighting columns with led as lighting source, suitable for installation in walking paths, gardens and squares. Body in stainless steel, with round shape. Complete with PPMA clear diffuser to avoid glare.

LUCE Q	EN5041	EN5042	EN5043
LED Colour	White or blue	White or blue	White or blue
LED Number	10	10	10
TOTAL Power	6W	6W	6W
Input	230Vac	230Vac	230Vac
Weight	1,8 kg	1,8 kg	1,8 kg
Insulation Class	I	I	I
IP Code	IP68	IP68	IP68
Dimensions	<b>Ø 102x190 mm</b>	<b>Ø 102x540 mm</b>	<b>Ø 102x801040 mm</b>
Body finishing	Brushed stainless steel		
Diffuser finishing	Clear	Clear	Clear

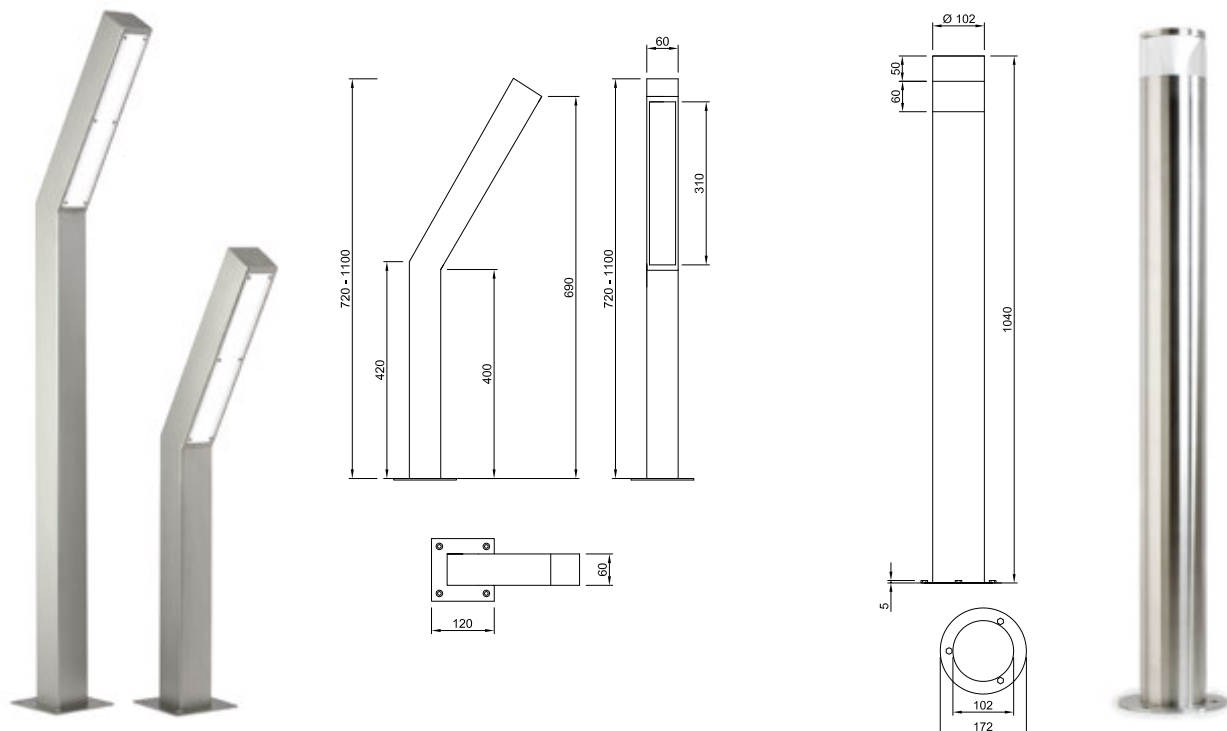

## LANCIA

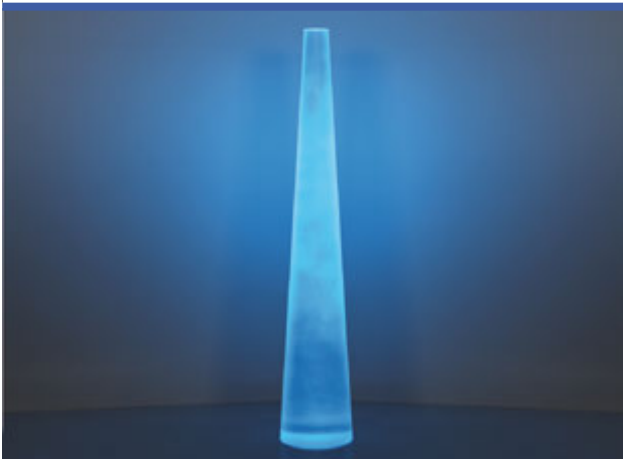

**Puntale decorativo per testapalo diam. 60 mm in policarbonato satinato. Con led da 1,2 W, colore su richiesta.**

Lighting spike for poles with decorative function. In satinated polycarbonate, with led 1,2W. Simple and elegant, it can be used in several installations.

LANCIA	ENLI0001
LED Colour	White or coloured
LED Number	1
TOTAL Power	1,2W
Input	350mA
Weight	0,5 kg
Insulation Class	I
IP Code	IP67
Dimensions	<b>Ø 60x340 mm</b>
Body finishing	Satinated polycarbonate

Notes: Driver not included

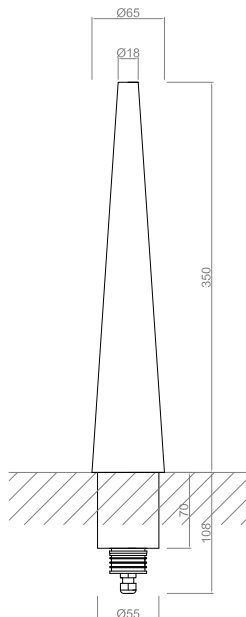

## PIPEDO



**Guida luminosa a led per illuminazione d'accento, installazione a soffitto e a parete. Corpo in alluminio anodizzato; cornice e viti in acciaio inox. Il grado di protezione è IP65; il sistema viene fornito con pressacavo metallico.**

Led luminaire for decorative lighting suitable for wall or ceiling installation. Body in anodized aluminium. Frame and screws in stainless steel. IP65 with nickeled brass cable gland.

PIPEDO	EN1160	EN1161
LED Colour	White	White
LED Number	3	3
TOTAL Power	3,6W	4,8W
Input	24Vdc	230Vca
Weight	0,4 kg	0,4 kg
Insulation Class	III	I
IP Code	<b>IP65</b>	<b>IP65</b>
Dimensions	<b>150x40x30 mm</b>	<b>150x40x30 mm</b>
Body finishing	Al anodized, frame in stainless steel	
Diffuser finishing	Clear	Clear

Notes: Drivers not included

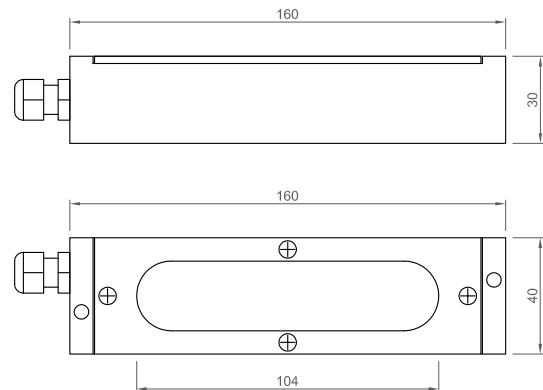









## MOSAICO



Apparecchio a led per applicazioni da interno ed esterno, per l'installazione a parete o a soffitto.  
**Led di alta potenza. Corpo in alluminio anodizzato o verniciato bianco RAL9010, opaco.**  
**Schermo di protezione in PMMA opale o chiaro. Attacco a muro in lamiera zincata con inserti magnetici.**

Led lighting fixture for indoor and outdoor, wall or ceiling installation. Body in anodized aluminium or white painted, RAL9010 matt. PMMA diffuser, matt or transparent. For wall fixing, with magnet.

MOSAICO	ENMB0112	ENMB0122
LED Colour	White 3950 K	White 3000 K
LED Type	Power led	Power led
LED Number	12	-
LED Power	2W	18W
TOTAL Power	25W - 550 lm	18W
Input	700mA in the luminaire	230Vac
Weight	0,5 kg	0,5 kg
Lens	-	-
Insulation Class	II	I
IP Code	IP40 - <b>IP65</b>	IP40 - <b>IP65</b>
Dimensions	<b>150x150x50 mm</b>	<b>150x150x50 mm</b>
Body	AL anodized and painted	AL anodized and painted
Diffuser	Clear or matt / PMMA	Clear or matt/ PMMA
Notes:	Driver not included	

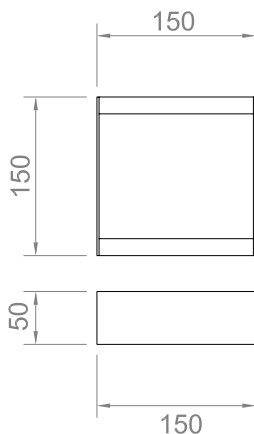

## MOSAICO downlight



Apparecchio da incasso per applicazioni in controsoffitto, sviluppato per illuminazione con power led alta potenza. Corpo in alluminio anodizzato o verniciato bianco RAL9010, opaco. Cornice per l'installazione in acciaio verniciato bianco RAL9010 opaco. Schermo di protezione in PMMA opale o chiaro.

Led lighting fixture for false ceiling applications. Body in anodized aluminium or white painting finish, RAL9010 matt, frame in steel white RAL9010 matt. PMMA diffuser, matt or transparent.

MOSAICO downlight	ENMD0112	ENMD0122
LED Colour	White 3950 K	White 3000 K
LED Type	Power led	Power led
LED Number	12	-
LED Power	2W	18W
TOTAL Power	25W - 550 lm	18W - 1590 lm
Input	700mA	230Vac
Weight	0,5 kg	0,5 kg
Lens	-	-
Insulation Class	II	I
IP Code	IP40 - <b>IP65</b>	IP40 - <b>IP65</b>
Dimensions	<b>175x175x57 mm</b>	<b>175x175x57 mm</b>
Body	AL anodized and painted	AL anodized and painted
Diffuser	Clear or matt / PMMA	Clear or matt/ PMMA
Notes:	Driver not included	

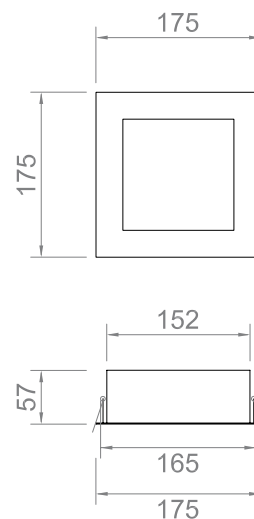

## BOA industrial



**Apparecchio a led da interno ed esterno per installazione a parete o a soffitto. Adatto per illuminazione di magazzini, gallerie, capannoni, pensiline, uffici, etc... Corpo in alluminio anodizzato. Schermo di protezione in PMMA opale o trasparente.**

Lighting fixture with high power led, for ceiling or wall installation. Suitable for warehouses, tunnels, canopies, offices, etc... Body in anodized aluminium, PMMA diffuser, clear or matt.

BOA industrial ENIBO 112	
LED Colour	White 3950 K
LED Type	Power led
LED Number	24 / 36 / 48 / 60 / 72 / 84 / 96 / 120 / 144
LED Power	2W
TOTAL Power	50 / 75 / 100 / 125 / 150 / 175 / 200 / 250 / 300 W
Input	230Vac
Insulation Class	I
IP Code	IP40 - <b>IP65</b>
Dimensions	<b>400/550/700/850/1000/1150/1300/1600/1900x150x150 mm</b>
Body finishing	AL anodized
Diffuser	Clear or Mat PMMA

Notes: Driver included on upper case. Dimmable version on request.  
Special lenght and powers available on request

Product types				
<b>ENBO 0124</b>	24	700mA	5500lm	50W
<b>ENBO 0136</b>	36	700mA	8250lm	75W
<b>ENBO 0148</b>	48	700mA	11000lm	100W
<b>ENBO 0160</b>	60	700mA	13750lm	125W
<b>ENBO 0172</b>	72	700mA	16500lm	150W
<b>ENBO 0184</b>	84	700mA	19320lm	175W
<b>ENBO 0196</b>	96	700mA	22080lm	200W
<b>ENBO 01120</b>	120	700mA	27600lm	250W
<b>ENBO 01144</b>	144	700mA	33120lm	300W

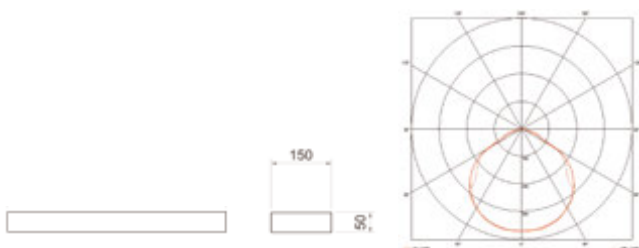

## IGUANA



Apparecchio decorativo con led ad altissima efficienza per installazione a muro. Illuminazione diretta o indiretta, orientabile.  
Corpo in alluminio estruso ed anodizzato grigio, staffa di installazione in acciaio zincato e verniciato bianco RAL9010 testurizzato. Driver incluso.

High efficiency decorative lighting luminaire, wall installation. Direct or indirect lighting, adjustable. Body in anodized aluminium complete with bracket and installation box in galvanized steel, painted in white RAL 9010. Driver included.

IGUANA	ENIG0112
LED COLOUR	White 3950K
LED TYPE	Power led
LED NUMBER	24
LED POWER	2W
TOTAL POWER	50W
INPUT	230Vac
WEIGHT	4 kg
LENS	-
INSULATION CLASS	I
IP CODE	IP40 - <b>IP65</b>
BODY	AL anodized and painted
DIMENSIONS	<b>295x310x162 mm</b>
DIFFUSER	clear or matt

Notes: driver included. Dimmable version on request

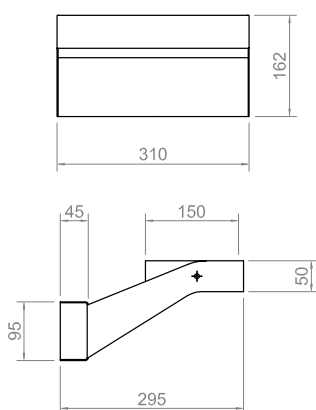

## VARANO



Apparecchio decorativo con led ad altissima efficienza per installazione a muro. Illuminazione diretta o indiretta, orientabile.  
Corpo in alluminio estruso ed anodizzato grigio, staffa di installazione in acciaio zincato e verniciato bianco RAL9010 testurizzato. Driver incluso.

High efficiency decorative lighting luminaire, wall installation. Direct or indirect lighting, adjustable. Body in anodized aluminium complete with bracket and installation box in galvanized steel, painted in white RAL 9010. Driver included.

VARANO	ENVA0112
LED COLOUR	White 3950K
LED TYPE	Power led
LED NUMBER	12
LED POWER	2W
TOTAL POWER	25W
INPUT	230Vac
WEIGHT	3 kg
LENS	-
INSULATION CLASS	I
IP CODE	IP40 - <b>IP65</b>
BODY	AL anodized and painted
DIMENSIONS	<b>295x310x162 mm</b>
DIFFUSER	clear or matt PMMA

Notes: driver included. Dimmable version on request

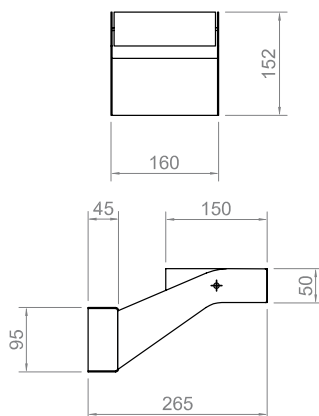

## GECO



Proiettore a led per installazione da interno ed esterno. Applicazione a muro o a terra, illuminazione diretta ed indiretta, orientabile, con staffe di fissaggio in acciaio zincato.  
Corpo in alluminio estruso ed anodizzato grigio, diffusore trasparente in metacrilato PMMA.

Led floodlight for interior and exterior installation. Suitable for wall and on ground installation, complete with galvanized steel brackets. Body in extruded aluminium, silver grey colour. Matt flat diffuser in PMMA.

GECO	ENGE012
LED COLOUR	White 3950K
LED TYPE	Power led
LED NUMBER	36/48/60/72
LED POWER	700mA
TOTAL POWER	75/100/125/150W
INPUT	700mA
WEIGHT	-
LENS	-
INSULATION CLASS	I - II
IP CODE	IP40 - <b>IP65</b>
BODY	AL anodized and painted
DIMENSIONS	<b>450/550/700/800x156x254mm</b>
DIFFUSER	clear or matt PMMA

Notes: driver included. Dimmable version on request

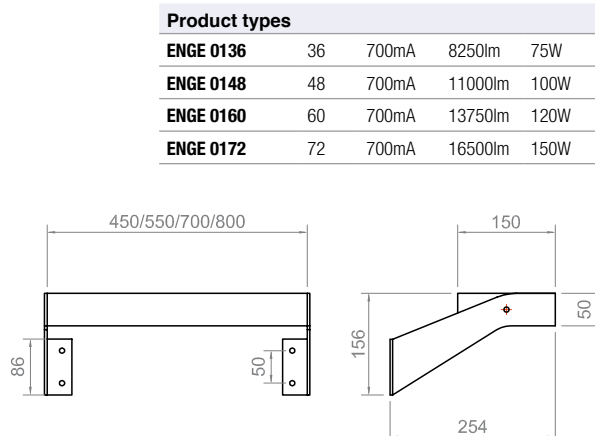

### Product types

<b>ENGE 0136</b>	36	700mA	8250lm	75W
<b>ENGE 0148</b>	48	700mA	11000lm	100W
<b>ENGE 0160</b>	60	700mA	13750lm	120W
<b>ENGE 0172</b>	72	700mA	16500lm	150W

**SOLE C**



**Apparecchio per illuminazione decorativa a led, installazione a parete o a soffitto. Base in alluminio e diffusore cilindrico in materiale plastico satinato. Progettato per power led ad alta efficienza. Montaggio mediante apposite viti di fissaggio. Alimentazione diretta 230Vac per facilitare l'installazione.**

Led lighting luminaire for wall or suspended installation. Anodized aluminium base and satinized cylindrical diffuser. For high power led, direct installation 230Vac. Screws for installation included.

SOLE C	EN7000	EN7001
LED Colour	White 3000K or 4000K	White 3000K or 4000K
LED Number	-	-
TOTAL Power	4W	8W
Input	230Vac	230Vac
Weight	0,7kg	0,7kg
Lens	-	-
Insulation Class	I	I
IP Code	IP40 - IP54	IP40 - IP54
Dimensions	<b>ø 89x60 mm</b>	<b>ø 89x60 mm</b>
Body finishing	AL anodized aluminium	AL anodized aluminium
Diffuser finishing	Cylindrical, matt	Cylindrical, matt

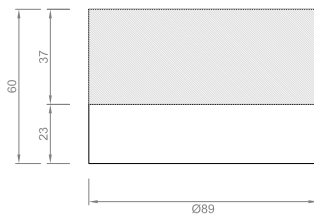

**SOLE E**



**Apparecchio per illuminazione decorativa a led, installazione a parete o a soffitto. Base in alluminio e diffusore ellittico in materiale plastico satinato. Progettato per power led ad alta efficienza. Montaggio mediante apposite viti di fissaggio. Alimentazione diretta 230Vac per facilitare l'installazione.**

Led lighting luminaire for wall or suspended installation. Anodized aluminium base and satinized elliptical diffuser. For high power led, direct installation 230Vac. Screws for installation included.

SOLE E	EN7020	EN7021
LED Colour	White 3000K or 4000K	White 3000K or 4000K
LED Number	-	-
TOTAL Power	4W	8W
Input	230Vac	230Vac
Weight	0,6kg	0,6kg
Lens	-	-
Insulation Class	I	I
IP Code	IP40 - IP54	IP40 - IP54
Dimensions	<b>ø 89x83mm</b>	<b>ø 89x83 mm</b>
Body finishing	AL anodized	AL anodized aluminium
Diffuser finishing	Convex, matt	Convex, matt

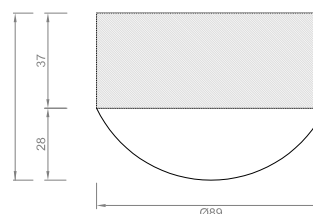

## CUBETTO



**Apparecchio a led per applicazione da interno o esterno. Corpo in alluminio anodizzato o verniciato. Vetro di protezione trasparente. Ideale per applicazioni in superfici piatte e uniformi. Illuminazione wall washer.**

Led lighting luminaire, for interior and exterior installation. Body in anodized or painted aluminium. Clear protection cover. Installation on wall or ceiling to highlight and wash building facades and to create strong visual effect.

CUBETTO	EN1150	EN1150-10
LED Colour	White 3000K or 4000K	White 3000K or 4000K
LED Number	1	1
TOTAL Power	1,2W or 2W	1,2W or 2W
Input	350mA - 500mA	350mA - 500mA
Weight	0,2 kg	0,4 kg
Lens	15°/25°/40°	15°/25°/40°
Insulation Class	III	III
IP Code	IP40 - <b>IP65</b>	IP40 - <b>IP65</b>
Dimensions	<b>38x38x60 mm</b>	<b>38x38x60 mm</b>
Body finishing	AL anodized	White RAL 9010
Diffuser finishing	Clear	Clear

Notes: Driver not included

## CUBETTO 2



**Apparecchio a led per applicazione da interno o esterno. Corpo in alluminio anodizzato o verniciato. Vetro di protezione trasparente. Ideale per applicazioni in superfici piatte e uniformi. Illuminazione wall washer.**

Led lighting luminaire, for interior and exterior installation. Body in anodized or painted aluminium. Clear protection cover. Installation on wall or ceiling to highlight and wash building facades and to create strong visual effect.

CUBETTO 2	EN1151	EN1151-10
LED Colour	White 3000K or 4000K	White 3000K or 4000K
LED Number	2	2
TOTAL Power	2x1,2 or 2x2W	2x1,2 or 2x2w
Input	350mA - 500mA	350mA - 500mA
Weight	0,4 kg	0,4 kg
Lens	15°/25°/40°	15°/25°/40°
Insulation Class	III	III
IP Code	IP40 - <b>IP65</b>	IP40 - <b>IP65</b>
Dimensions	<b>38x46x60 mm</b>	<b>38x46x60 mm</b>
Body finishing	AL anodized	White RAL 9010
Diffuser finishing	Clear	Clear

Notes: Driver not included

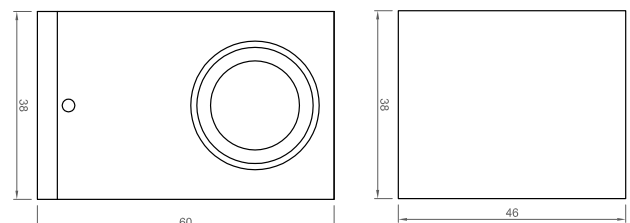
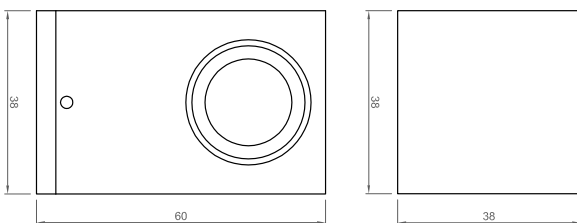





## PUNTO round



Faretto da incasso a led per illuminazione d'accento, di forma rotonda. Corpo in alluminio anodizzato, completo di molle per il fissaggio.  
Driver non incluso.

Recessed led spotlight for decorative lighting. Body in anodized aluminium, complete with fixing clips or O-ring. This spot light comes in round shape. Power supply units are not included.

PUNTO round	EN3043	EN3043-17	EN3043-10	EN3043-50
LED Colour	White 3000K or 4000K			
LED Number	1	1	1	1
TOTAL Power	1,2W	1,2W	1,2W	1,2W
Input	350mA	350mA	350mA	350mA
Weight	0,011 kg	0,011 kg	0,011 kg	0,011 kg
Insulation Class	III	III	III	III
IP Code	<b>IP67</b>	<b>IP67</b>	<b>IP67</b>	<b>IP67</b>
Dimensions	<b>Ø 25x21 mm</b>	<b>Ø 25x21 mm</b>	<b>Ø 25x21 mm</b>	<b>Ø 25x21 mm</b>
Recessed dimension	Ø 19 mm	Ø 19 mm	Ø 19 mm	Ø 19 mm
Body finishing	AL anodized	Chrome	White	Stainless Steel
Diffuser finishing	Matt	Matt	Matt	Matt

Notes: Drivers not included

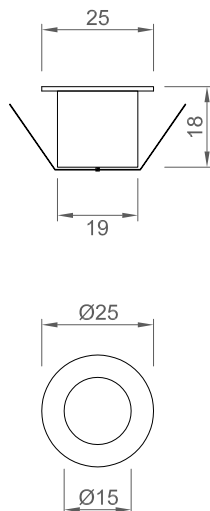

## PUNTO Q square



Faretto da incasso a led per illuminazione d'accento, di forma quadrata. Corpo in alluminio anodizzato, completo di molle per il fissaggio.  
Driver non incluso.

Recessed led spotlight for decorative lighting. Body in anodized aluminium, complete with fixing clips or O-ring. This spot light comes in round shape. Power supply units are not included.

PUNTO square	EN3045	EN3045-17	EN3045-10	EN3045-50
LED Colour	White 3000K or 4000K			
LED Number	1	1	1	1
TOTAL Power	1,2W	1,2W	1,2W	1,2W
Input	350mA	350mA	350mA	350mA
Weight	0,11 kg	0,11 kg	0,11 kg	0,11 kg
Insulation Class	III	III	III	III
IP Code	<b>IP67</b>	<b>IP67</b>	<b>IP67</b>	<b>IP67</b>
Dimensions	<b>25x25x21 mm</b>	<b>25x25x21 mm</b>	<b>25x25x21 mm</b>	<b>25x25x21 mm</b>
Recessed dimension	Ø 19 mm	Ø 19 mm	Ø 19 mm	Ø 19 mm
Body finishing	AL anodized	Chrome	White	Stainless Steel
Diffuser finishing	Matt	Matt	Matt	Matt

Notes: Drivers not included

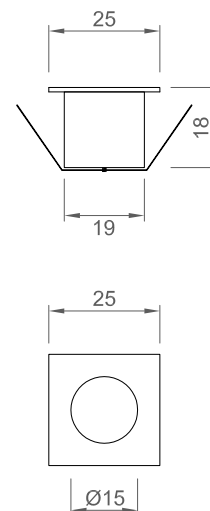



## LUCE round



**Faretto da incasso a led per illuminazione d'accento. Corpo in alluminio anodizzato o verniciato. Vetro di protezione in materiale plastico trasparente. Ghiera modello tondo leggermente svasato in alluminio anodizzato. Completo di clips di fissaggio.**

Led spot lighting fixture for recessed installation, suitable to an intensive lighting effects. Body in anodized aluminium or painted aluminium. Aluminium frame in round shape. Clear protection glass and installation clips.

## LUCE Q square



**Faretto da incasso a led per illuminazione d'accento. Corpo in alluminio anodizzato o verniciato. Vetro di protezione in materiale plastico trasparente. Ghiera modello quadrato in alluminio anodizzato. Completo di clips di fissaggio.**

Led spot lighting fixture for recessed installation, suitable to an intensive lighting effects. Body in anodized aluminium or painted aluminium. Aluminium frame in squared shape. Clear protection glass and installation clips.

LUCE	EN3060	EN3060-10	EN3060-50
LED Colour	White/coloured 3000K or 4000K		
LED Number	1	1	1
TOTAL Power	1,2W - 2W	1,2W - 2W	1,2W - 2W
Input	350mA - 500mA	350mA - 500mA	350mA - 500mA
Weight	0,1 kg	0,1 kg	0,1 kg
Lens	15°/ 25°/ 40°	15°/ 25°/ 40°	15°/ 25°/ 40°
Insulation Class	III	III	III
IP Code	IP67	IP67	IP67
Dimensions	<b>Ø 44x66 mm</b>	<b>Ø 44x66 mm</b>	<b>Ø 44x66 mm</b>
Recessed dimension	Ø 36 mm	Ø 36 mm	Ø 36 mm
Body finishing	AL anodized	White finishing	Stainless Steel
Diffuser finishing	Transparent	Transparent	Transparent

LUCE Q	EN3160	EN3160-10	EN3160-50
LED Colour	White/coloured 3000K or 4000K		
LED Number	1	1	1
TOTAL Power	1,2W - 2W	1,2W - 2W	1,2W - 2W
Input	350mA - 500mA	350mA - 500mA	350mA - 500mA
Weight	0,1 kg	0,1 kg	0,1 kg
Lens	15°/ 25°/ 40°	15°/ 25°/ 40°	15°/ 25°/ 40°
Insulation Class	III	III	III
IP Code	IP67	IP67	IP67
Dimensions	<b>44x44x66 mm</b>	<b>44x44x66 mm</b>	<b>49x49x66 mm</b>
Recessed dimension	Ø 36 mm	Ø 36 mm	Ø 36 mm
Body finishing	AL anodized	White finishing	Stainless Steel
Diffuser finishing	Transparent	Transparent	Transparent

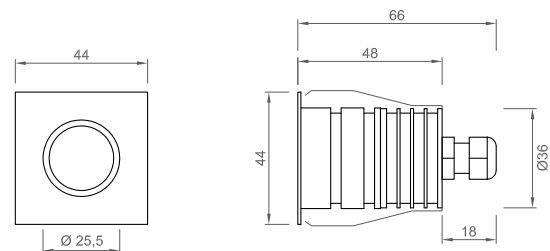
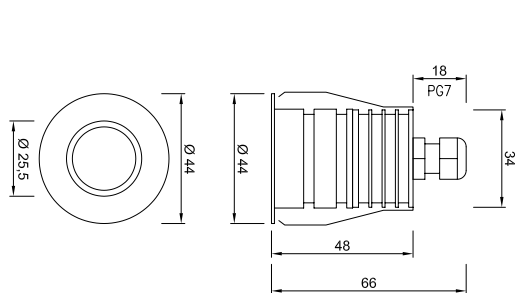



## LUCE SOFT round



## LUCE SOFT Q square



## MAX 3 SOFT



Faretto da incasso a led di forma rotonda; grazie al design lineare e alla cura della forma estetica questo prodotto oltre che essere utilizzato per l'illuminazione d'accento risulta un elemento decorativo nell'ambiente in cui viene applicato. Corpo in alluminio anodizzato, completo di molle per il fissaggio. Copertura decorativa in materiale plastico con effetto opacizzante.

Recessed led spotlight for decorative lighting. Body in anodized aluminium, complete with fixing clips or O-ring. Protection degree is IP65. This spot light comes with a frosted cover in a round or squared shape.

Faretto da incasso a led di forma quadrata; grazie al design lineare e alla cura della forma estetica questo prodotto oltre che essere utilizzato per l'illuminazione d'accento risulta un elemento decorativo nell'ambiente in cui viene applicato. Corpo in alluminio anodizzato, completo di molle per il fissaggio. Copertura decorativa in materiale plastico con effetto opacizzante.

Recessed led spotlight for decorative lighting. Body in anodized aluminium, complete with fixing clips or O-ring. Protection degree is IP65. This spot light comes with a frosted cover in a round or squared shape.

Apparecchio decorativo da incasso a led per applicazione da interno o esterno.

Corpo in alluminio anodizzato, diffusore satinato in metacrilato.

Led luminaire for recessed installation, interior and exterior. Body in anodized aluminium. Complete with matt diffuser, vandal resistant. Fixing clips for installation.

LUCE SOFT	EN3005	EN3004
LED Colour	White 3000K or 4000K	
LED Number	1	3
TOTAL Power	2W	3W
Input	500mA	350mA
Weight	0,1 kg	0,1 kg
Lens	-	-
Insulation Class	III	III
IP Code	<b>IP65</b>	<b>IP65</b>
Dimensions	<b>ø 44x66 mm</b>	<b>ø 44x66 mm</b>
Recessed dimension	ø 36 mm	ø 36 mm
Body finishing	AL anodized	AL anodized
Diffuser finishing	Matt elliptical	Matt elliptical

Notes: Drivers not included

LUCE SOFT Q	EN3001	EN3000
LED Colour	White 3000K or 4000K	
LED Number	1	3
TOTAL Power	2W	3W
Input	500mA	350mA
Weight	0,1 kg	0,1 kg
Lens	-	-
Insulation Class	III	III
IP Code	<b>IP65</b>	<b>IP65</b>
Dimensions	<b>44x 44x66 mm</b>	<b>44x44x66 mm</b>
Recessed dimension	ø 36 mm	ø 36 mm
Body finishing	-	AL anodized
Diffuser finishing	Matt square	Matt square

Notes: Drivers not included

MAX 3 SOFT	EN3225
LED Colour	White 3000K or 4000K
LED Number	-
TOTAL Power	4W
Input	230V
Weight	0,3 kg
Lens	15° / 25° / 60°
Insulation Class	I
IP Code	<b>IP65</b>
Dimensions	<b>ø 94x70 mm</b>
Recessed dimensions	ø 70 mm
Body finishing	AL anodized
Diffuser finishing	Cylindrical matt

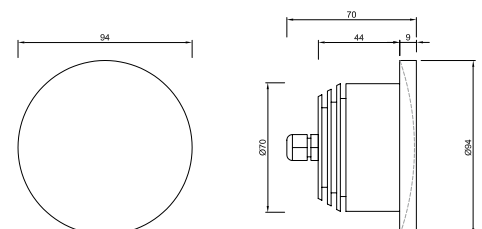
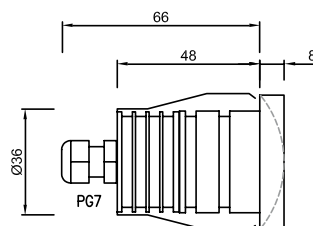
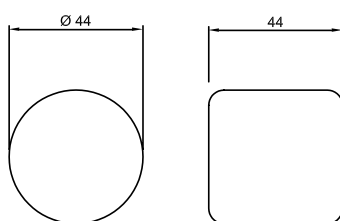

BANCA DI ROMANO E S.CATERINA



poltron sofa

poltron sofa



## MAX 3 round



**Apparecchio da incasso a led per applicazione da interno o esterno. Corpo in alluminio anodizzato o verniciato. Diffusore trasparente, antisfondamento in materiale plastico.**

Led luminaire for recessed installation. Body in anodized aluminium. Round frame with transparent diffuser, in plastic material.

MAX 3 round	EN3220	EN3220-10
LED Colour	White 3000K or 4000K	White 3000K or 4000K
LED Number	3	3
TOTAL Power	3,6W - 6W	3,6W - 6W
Input	350mA - 500mA	350mA - 500mA
Weight	0,35 kg	0,35 kg
Lens	15° / 25° / 60°	15° / 25° / 60°
Insulation Class	III	III
IP Code	<b>IP67</b>	<b>IP67</b>
Dimensions	<b>ø 94x65 mm</b>	<b>ø 94x65 mm</b>
Recessed dimensions	ø 70 mm	ø 70 mm
Body finishing	AL anodized	AL white RAL9010
Diffuser finishing	Clear	Clear
Driver	not included	not included

MAX 3 round	EN3220-50	EN3229
LED Colour	White 3000K or 4000K	White 3000K or 4000K
LED Number	3	-
TOTAL Power	3,6W - 6W	4W
Input	350mA - 500mA	230Vac
Weight	0,35 kg	0,35 kg
Lens	15° / 25° / 60°	15° / 25° / 60°
Insulation Class	III	I
IP Code	<b>IP67</b>	<b>IP67</b>
Dimensions	<b>ø 94x65 mm</b>	<b>ø 94x65 mm</b>
Recessed dimensions	ø 70 mm	ø 70 mm
Body finishing	Stainless Steel	AL anodized
Diffuser finishing	Clear	Clear
Driver	not included	-

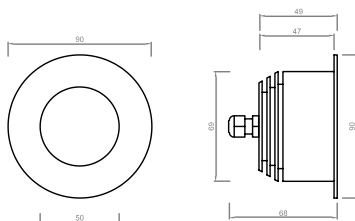

## MAX 3 Q square



**Apparecchio da incasso a led per applicazione da interno o esterno. Corpo in alluminio anodizzato o verniciato. Diffusore trasparente, antisfondamento in materiale plastico.**

Led luminaire for recessed installation. Body in anodized aluminium. Squared frame with transparent diffuser, in plastic material.

MAX 3 Q square	EN3222	EN3222-10
LED Colour	White 3000K or 4000K	White 3000K or 4000K
LED Number	3	3
TOTAL Power	3,6W - 6W	3,6W - 6W
Input	350mA - 500mA	350mA - 500mA
Weight	0,35 kg	0,35 kg
Lens	15° / 25° / 60°	15° / 25° / 60°
Insulation Class	III	III
IP Code	<b>IP67</b>	<b>IP67</b>
Dimensions	<b>94x94x65 mm</b>	<b>94x94x65 mm</b>
Recessed dimensions	ø 70 mm	ø 70 mm
Body finishing	AL anodized	White RAL9010
Diffuser finishing	Clear	Clear
Driver	not included	not included

MAX 3 Q square	EN3222-50	EN3230
LED Colour	White 3000K or 4000K	White 3000K or 4000K
LED Number	3	-
TOTAL Power	3,6W - 6W	4W
Input	350mA - 500mA	230Vac
Weight	0,35 kg	0,35 kg
Lens	15° / 25° / 60°	15° / 25° / 60°
Insulation Class	III	I
IP Code	<b>IP67</b>	<b>IP67</b>
Dimensions	<b>94x94x65 mm</b>	<b>94x94x65 mm</b>
Recessed dimensions	ø 70 mm	ø 70 mm
Body finishing	Stainless steel	AL anodized
Diffuser finishing	Clear	Clear
Driver	not included	-

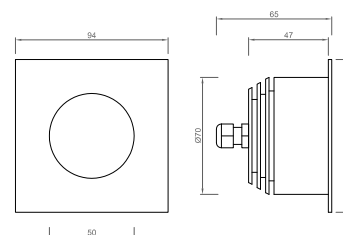

## LUCE proiettore



**Proiettore a led dalle dimensioni ridotte e ottimo rendimento. Corpo in alluminio con staffe per il fissaggio. Vetro di protezione trasparente ad elevata resistenza. Viti e accessori per l'installazione. Su richiesta picchetto.**

Small spotlight based on a unique single led with high output. Body in aluminium with fixing bracket in stainless steel. It can be used to light building façades, gardens or displays. On request, spike can be added.

LUCE PROIETTORE	EN3063	EN3063-50
LED Colour	White 3000K or 4000K	White 3000K or 4000K
LED Number	1	1
TOTAL Power	1,2W	1,2W
Input	350mA	350mA
Weight	0,2 kg	0,2 kg
Insulation Class	III	III
IP Code	<b>IP67</b>	<b>IP67</b>
Dimensions	<b>45x74x67 mm</b>	<b>45x74x67 mm</b>
Body finishing	AL anodized	AL anodized
Diffuser finishing	Clear	Clear

Notes: Drivers not included

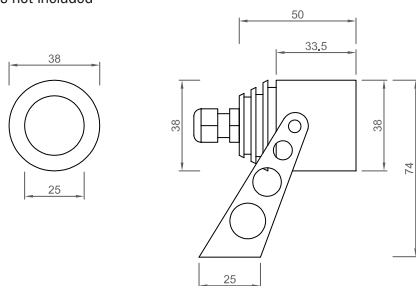

**Picchetto in acciaio inox - Stainless steel picket**

SPIKES	ENP001	ENP002
Dimensions	<b>250 mm</b>	<b>170 mm</b>

## MAX3 proiettore



**Faretto proiettore a led per interni ed esterni, di facile installazione. Corpo in alluminio con staffe per il fissaggio in acciaio inox. Diffusore trasparente, ad elevata resistenza ed antisfondamento, in materiale plastico. Staffe, viti ed accessori per il fissaggio. Su richiesta picchetto.**

Led lighting floodlight, interior and exterior, IP67. This product was designed to complete our range of Max 3 and in order to meet increasing requests for mains onboard led luminaire. Body in anodized aluminium, 3 led high power, plastic shade, installation bracket in stainless steel. On request spike can be added.

MAX3 PROIETTORE	EN3221	EN3231
LED Colour	White 3000K or 4000K	White 3000K or 4000K
LED Number	3	3
TOTAL Power	3,6W	4W
Input	350mA	230Vac
Weight	0,4 kg	0,35 kg
Insulation Class	III	III
IP Code	<b>IP67</b>	<b>IP67</b>
Dimensions	<b>83x90x67mm</b>	<b>83x90x67mm</b>
Body finishing	AL anodized	AL anodized
Diffuser finishing	Clear	Clear

Notes: Drivers not included

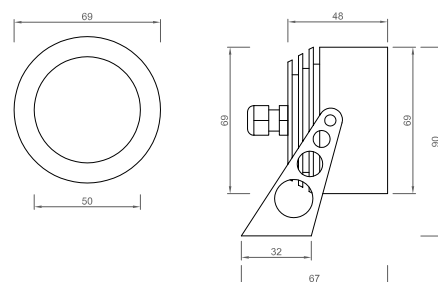

**Picchetto in acciaio inox - Stainless steel picket**

SPIKES	ENP001	ENP002
Dimensions	<b>250 mm</b>	<b>170 mm</b>



## OTERO proiettore



**Proiettore a led per interni ed esterni, di facile installazione. Corpo in alluminio con staffe per il fissaggio. Vetro di protezione trasparente ad elevata resistenza. Viti e accessori per il fissaggio. Su richiesta picchetto.**

Led spotlight with high output. Body in aluminium with fixing bracket. Ideal for highlight a specific feature. It can be used to light building façades, gardens or displays. Spike can be added on request.

OTERO P.	EN9000	EN9003	EN9001	EN9001-50
LED Colour	White 3000 or 4000K			
LED Number	9		12	12
TOTAL Power	10,8W	16W	14,4W	14,4W
Input	350mA	230Vac		
Weight	2 kg	2 kg	2 kg	2,2 kg
Insulation Class	III	III	III	III
IP Code	<b>IP67</b>	<b>IP67</b>	<b>IP67</b>	<b>IP67</b>
Dimensions	<b>170x165x7mm</b>	<b>170x165x7mm</b>	<b>170x165x7mm</b>	<b>170x165x7mm</b>
Body finishing	AL anodized	AL anodized	AL anodized	AL anodized
Frame	-	-	-	-
Diffuser	Clear	Clear	Clear	Clear

Notes: Drivers not included

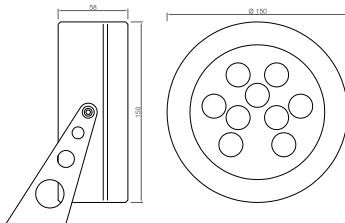

**Picchetto in acciaio inox - Stainless steel picket**

SPIKES	ENP001	ENP002
Dimensions	<b>250 mm</b>	<b>170 mm</b>

## OTERO incasso



**Apparecchio da incasso a led, calpestabile per interni ed esterni, di facile installazione. Corpo in alluminio anodizzato. Policarbonato di protezione trasparente ad elevata resistenza, temperatura superficiale <40°C. Led di potenza ad alta luminosità.**

Recessed led spot light for easy installation. It is walkable suitable for interior and exterior applications. Body in anodized aluminium with polycarbonate clear protection shade; highly resistant, surface temperature <40°. High power led.

OTERO	EN8000	EN8010	EN8010-50	EN8030
LED Colour	4000	4000		
LED Number	9	12	12	
TOTAL Power	11W	14,5W	14,5W	16W
Input	350mA	350mA	350mA	230mA
Weight	1,7 kg	1,7 kg	1,7 kg	1,7 kg
Insulation Class	III	III	III	III
IP Code	<b>IP67</b>	<b>IP67</b>	<b>IP67</b>	<b>IP67</b>
Dimensions	<b>Ø 188x55 mm</b>	<b>Ø 188x55 mm</b>	<b>Ø 188x55 mm</b>	<b>Ø 188x55 mm</b>
Body finishing	AL anodized	AL anodized	AL anodized	AL anodized
Frame	-	Stainless steel	-	-
Diffuser	Clear	Clear	Clear	Clear

Notes: Drivers not included

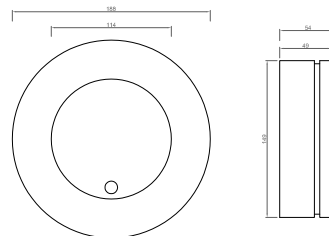







**Apparecchio da incasso a led per applicazione da interno o esterno. Corpo in alluminio anodizzato o verniciato. Vetro di protezione in materiale plastico trasparente. Ghiera in alluminio, acciaio o bronzo con 1/2/4 aperture. Completo di clips per il fissaggio.**

Led lighting fixtures for recessed installation, highly elegant, for interior and exterior installation. Body and ring in anodized or painted aluminium. Clear protection glass. Ring in aluminium, steel or bronze, with 1/2/4 holes for light diffusion. Steel fixing clips for recessed or wall mounting.

**Apparecchio da incasso a led per applicazione da esterno. Corpo in alluminio anodizzato. Ghiera in alluminio con 1 apertura, a 180°. Completo o-ring per il fissaggio.**

Led lighting luminaire for recessed installation, highly elegant, for interior and exterior installation. Body and ring in anodized or painted aluminium. Clear protection glass. Ring in aluminium with one opening 180° for light diffusion. Steel fixing clips for recessed or wall mounting.

	<b>RAGGIO 1 EN3777</b>	<b>RAGGIO 2 EN3776</b>	<b>RAGGIO 4 EN3775</b>
LED Colour	White 3000K or 4000K	White 3000K or 4000K	White 3000K or 4000K
LED Number	1	1	1
TOTAL Power	1,2W	1,2W	1,2W
Input	350mA	350mA	350mA
Weight	0,1 kg	0,1 kg	0,1 kg
Insulation Class	III	III	III
IP Code	<b>IP67</b>	<b>IP67</b>	<b>IP67</b>
Dimensions	<b>Ø 44x75 mm</b>	<b>Ø 44x75 mm</b>	<b>Ø 44x75 mm</b>
Recessed dimensions	Ø 36 mm	Ø 36 mm	Ø 36 mm
Body finishing	AL, White, Stainless steel and Bronze		
Frame	Al anodized or stainless steel	Al anodized or stainless steel	Al anodized or stainless steel

Notes: Driver not included

	<b>UFO 180</b>	<b>EN3801S</b>
LED Colour	White 3000K or 4000K	White 3000K or 4000K
LED Number		2
TOTAL Power		2,4W
Input		350mA
Weight		0,4 kg
Insulation Class		III
IP Code		<b>IP67</b>
Dimensions		<b>Ø 94x85 mm</b>
Recessed dimensions		Ø 70 mm
Body finishing		AL anodized
Frame		180° Al anodized

Notes: Drivers not included

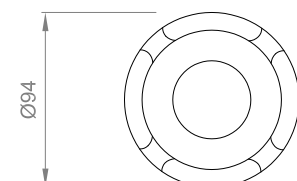
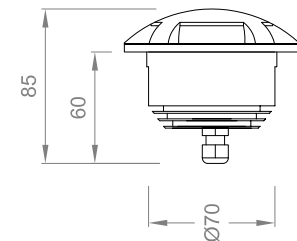
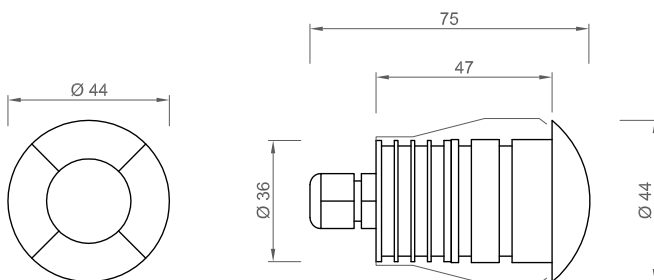

## UFO 1



Apparecchio da incasso a led per applicazione da esterno. Corpo in alluminio anodizzato. Ghiera in alluminio con 1 apertura. Completo o-ring per il fissaggio.

Led lighting luminaire for recessed installation, highly elegant, for interior and exterior installation. Body and ring in anodized or painted aluminium. Clear protection glass. Ring in aluminium with one opening for light diffusion. Steel fixing clips for recessed or wall mounting.

UFO 1	EN3800	EN3806
LED Colour	White 3000K or 4000K	
LED Number	1	-
TOTAL Power	1,2W	4W
Input	350mA	230Vac
Weight	0,5 kg	0,5 kg
Insulation Class	III	I
IP Code	<b>IP67</b>	<b>IP67</b>
Dimensions	<b>Ø 94x85 mm</b>	<b>Ø 94x85 mm</b>
Recessed dimensions	Ø 70 mm	Ø 70 mm
Body finishing	AL anodized	AL anodized
Frame	Al anodized or stainless steel	

Notes: Drivers not included

## UFO 2



Apparecchio da incasso a led per applicazione da esterno. Corpo in alluminio anodizzato. Ghiera in alluminio con 2 aperture. Completo o-ring per il fissaggio.

Led lighting luminaire for recessed installation, highly elegant, for interior and exterior installation. Body and ring in anodized or painted aluminium. Clear protection glass. Ring in aluminium with two openings for light diffusion. Steel fixing clips for recessed or wall mounting.

UFO 2	EN3801	EN3807
LED Colour	White 3000K or 4000K	
LED Number	2	-
TOTAL Power	2,4W	4W
Input	350mA	230Vac
Weight	0,45 kg	0,45 kg
Insulation Class	III	III
IP Code	<b>IP67</b>	<b>IP67</b>
Dimensions	<b>Ø 94x85 mm</b>	<b>Ø 94x85 mm</b>
Recessed dimensions	Ø 70 mm	Ø 70 mm
Body finishing	AL anodized	AL anodized
Frame	Al anodized or stainless steel	

Notes: Drivers not included

## UFO 4



Apparecchio da incasso a led per applicazione da esterno. Corpo in alluminio anodizzato. Ghiera in alluminio con 4 aperture. Completo o-ring per il fissaggio.

Led lighting luminaire for recessed installation, highly elegant, for interior and exterior installation. Body and ring in anodized or painted aluminium. Clear protection glass. Ring in aluminium with 4 openings for light diffusion. Steel fixing clips for recessed or wall mounting.

UFO 4	EN3802	EN3808
LED Colour	White 3000K or 4000K	
LED Number	4	-
TOTAL Power	4,8W	4W
Input	350mA	230Vac
Weight	0,4 kg	0,4 kg
Insulation Class	III	III
IP Code	<b>IP67</b>	<b>IP67</b>
Dimensions	<b>Ø 94x85 mm</b>	<b>Ø 94x85 mm</b>
Recessed dimensions	Ø 70 mm	Ø 70 mm
Body finishing	AL anodized	AL anodized
Frame	Al anodized or stainless steel	

Notes: Drivers not included

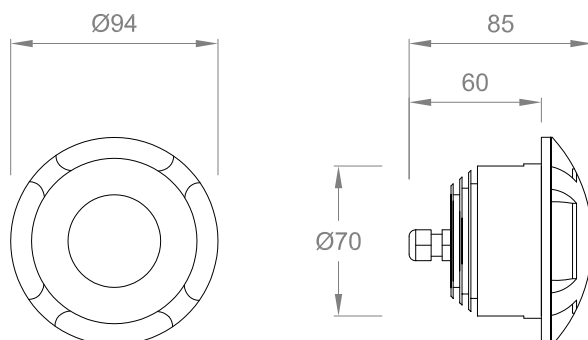



## DADO 5



## DADO 10



**Apparecchio decorativo a led, da interno ed esterno, per applicazioni incassate a parete o a terra. La forma geometrica e semplice permette l'installazione in ogni tipo di ambiente. Particolarmente adatto per eliminare gli abbagliamenti e creare un effetto cubo di luce riflessa. Corpo in alluminio, verniciato bianco.**

Decorative led luminaire, for interiors and exteriors, wall or ground recessed installation. It can be installed in any palce thanks to its geometrical and simple shape. Glare free thank to the indirect light emission. Body in painted aluminium.

DADO 5	EN3300
LED Colour	White or coloured
LED Number	1
TOTAL Power	2W
Input	500VmA
Weight	0,1 kg
Insulation Class	III
IP Code	<b>IP67</b>
Dimensions	<b>50x50x116 mm</b>
Recessed dimensions	Ø36x66 mm
Body finishing	Painted aluminium RAL9010
Diffuser finishing	Clear PMMA

Notes: Drivers not included

DADO 10	EN3310
LED Colour	White or coloured
LED Number	1
TOTAL Power	6W
Input	500VmA
Weight	0,3 kg
Insulation Class	III
IP Code	<b>IP67</b>
Dimensions	<b>100x100x165mm</b>
Recessed dimensions	Ø36x66 mm
Body finishing	Painted aluminium RAL9010
Diffuser finishing	Clear PMMA

Notes: Drivers not included

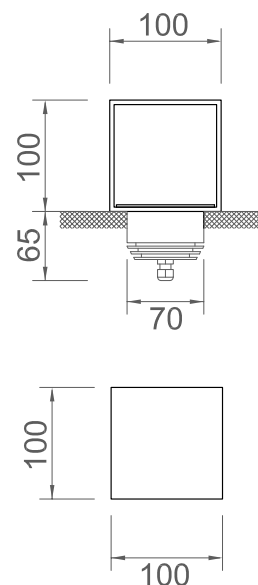
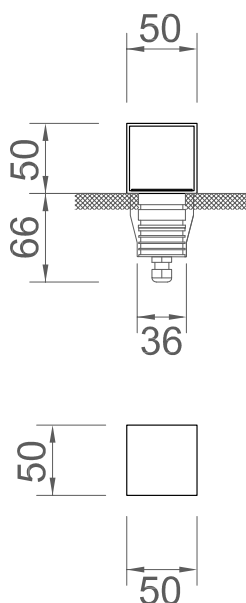

## SANPIETRINO



**Incasso a led, finta mattonella in policarbonato, carrabile, per installazioni esterne.**

Overwalkable brick with led, for exteriors.

## FASCIA

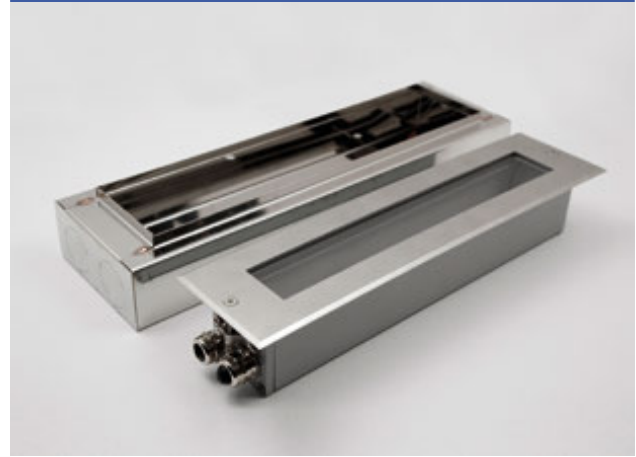

**Incasso lineare a led, profilo in alluminio, ghiera in acciaio aisi 316 e schermo in policarbonato piano trasparente. Sviluppato per power led ad altissima efficienza.**

Linear led luminaire, aluminium profile, frame in stainless steel AISI 316I and clear diffuser. Designed for high efficiency led.

PIPEDO	ENSP0111	ENSP0112
LED Colour	White	3000 or 4000K
LED Number	1	0
TOTAL Power	2W	4W
Input	500mA	230Vac
Weight	0,5 kg	0,5 kg
Insulation Class	III	I
IP Code	<b>IP67</b>	<b>IP67</b>
Dimensions	<b>90x75x80</b>	<b>90x75x80</b>
Body finishing	-	-
Diffuser finishing	Satinated polycarbonate	Satinated polycarbonate

Notes: Driver not included

PIPEDO	EN1102	EN1103
LED Colour	3000K	3000K
LED Number	6	18
TOTAL Power	7,5W	22,5
Input	24V	24V
Weight	2,5 kg	4,5 kg
Insulation Class	III	III
IP Code	<b>IP67</b>	<b>IP67</b>
Dimensions	<b>400x100x65 mm</b>	<b>950x100x65 mm</b>
Body finishing	AL anodized and steel AISI 316	AL anodized and steel AISI 316
Diffuser	Clear	Clear

Notes: Driver not included

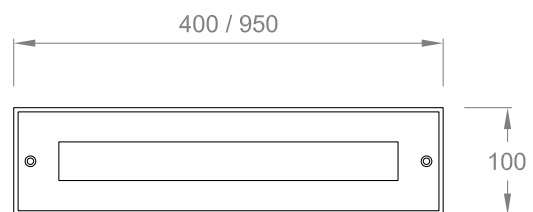
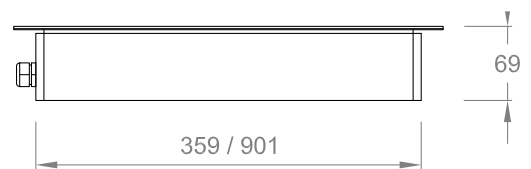
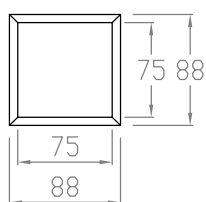
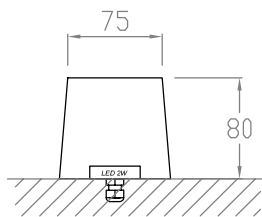



## NETTO round



**Segnapasso da incasso a led per installazione da interno ed esterno. Ghiera tonda in alluminio naturale anodizzato o verniciato. Luce di cortesia o per illuminazione generale. Completo di clips di fissaggio.**

Recessed led marker for indoors and outdoors. Suitable for courtesy light. Round frame in anodized aluminium, complete with fixing clips.

NETTO T	EN3070	EN3071
LED Colour	White 3000K or 4000K	
LED Number	1	1
TOTAL Power	1,2W	1,2W
Input	350mA	350mA
Weight	0,1 kg	0,1 kg
Insulation Class	III	III
IP Code	<b>IP67</b>	<b>IP67</b>
Dimensions	<b>ø 44x65 mm</b>	<b>ø 44x65 mm</b>
Recessed dimensions	ø 36 mm	ø 36 mm
Frame	Asymmetrical	Symmetrical
Body finishing	AL anodized	AL anodized
Diffuser finishing	Clear	Clear

Notes: Driver not included

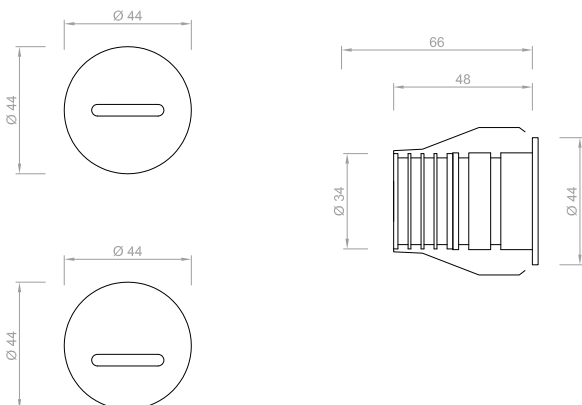

## NETTO Q square



**Segnapasso da incasso a led per installazione da interno ed esterno. Ghiera quadrata in alluminio naturale anodizzato o verniciato. Luce di cortesia o per illuminazione generale. Completo di clips di fissaggio.**

Recessed led marker for indoors and outdoors. Suitable for courtesy light. Frame in anodized aluminium, complete with fixing clips.

NETTO Q	EN3170	EN3171
LED Colour	White 3000K or 4000K	
LED Number	1	1
TOTAL Power	1,2W	1,2W
Input	350mA	350mA
Weight	0,1 kg	0,1 kg
Insulation Class	III	III
IP Code	<b>IP67</b>	<b>IP67</b>
Dimensions	<b>44x44x66 mm</b>	<b>44x44x66 mm</b>
Recessed dimensions	ø 36 mm	ø 36 mm
Frame	Asymmetrical	Symmetrical
Body finishing	AL anodized	AL anodized
Diffuser finishing	Clear	Clear

Notes: Driver not included

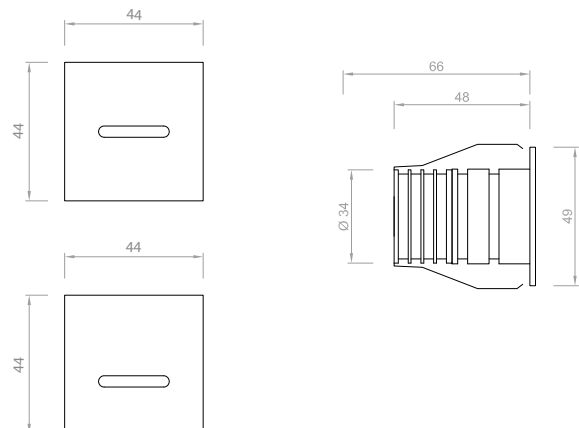

## LUNA



## GOCCIA

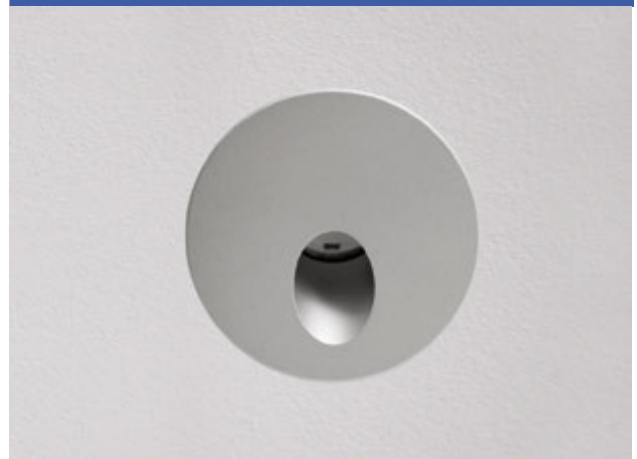

**Segnapasso a led per installazione da interno ed esterno. Ghiera in alluminio naturale anodizzato o verniciato. Diffusore in materiale plastico. Completo di clips di fissaggio.**

Led marker for indoor and outdoor. Frame in anodized aluminium. Diffuser in plexiglass material, fixing clips for installation.

**Segnapasso da incasso a led per installazione da interno. Ghiera in alluminio anodizzato.**

**Completo di clips di fissaggio e adatto per scatola standard Ø 65 mm.**

Asymmetrical lighting fixture with led technology. Body in anodized or painted aluminium. Suitable for installation on standard boxes Ø 65mm. Complete with fixing clips.

LUNA	EN3061	EN3061-10
LED Colour	3000K or 4000K	3000K or 4000K
LED Number	1	1
TOTAL Power	1,2W	1,2W
Input	350mA	350mA
Weight	0,1 kg	0,1 kg
Insulation Class	III	III
IP Code	<b>IP67</b>	<b>IP67</b>
Dimensions	<b>Ø 44x68,5 mm</b>	<b>Ø 44x68,5 mm</b>
Recessed dimensions	Ø 36 mm	Ø 36 mm
Body finishing	AL anodized	AL white RAL9010
Diffuser finishing	Clear	Clear

Notes: Driver not included

GOCCIA	EN4020
LED Colour	White 3000K or 4000K
LED Number	1
TOTAL Power	1,2W
Input	350mA
Weight	0,3 kg
Insulation Class	III
IP Code	<b>IP67</b>
Dimensions	<b>Ø 74x47 mm</b>
Recessed dimensions	Ø 57 mm
Body finishing	AL anodized
Diffuser finishing	-

Notes: Driver not included

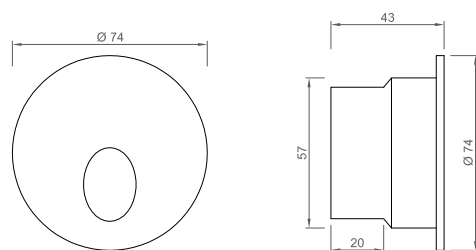
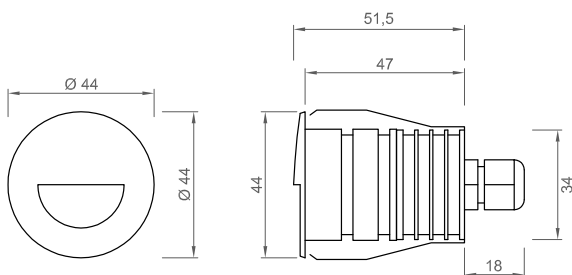

## PALPEBRA



## ILLUMINA



**Segnapasso da incasso a led per applicazione da interno o esterno. Corpo in alluminio anodizzato o verniciato. Adatto per installazione su scatola rettangolare tipo 503. Sistema di serraggio con viti a scomparsa.**

Led marker for asymmetrical recessed installation, for interiors and exteriors. Body and frame in aluminium, anodized or painted. Suitable for application with a plastic box, type 503. Closing device with foldaway screws.

**Segnapasso da incasso a led per applicazione da interno o da esterno. Corpo e cornice in alluminio anodizzato o verniciato. Schermo opale in plexiglass. Adatto per installazione su scatola rettangolare tipo 503. Sistema di serraggio con viti a scomparsa.**

Led marker for asymmetrical recessed installation, indoor and outdoor.. Body and frame in aluminium, anodized or painted. Closing cover in plastic, customized on request. Suitable for installation with plastic box, type 503. Closing device with foldway screws.

PALPEBRA	EN4003	EN4001
LED Colour	White 3000K or 4000K	White 3000K or 4000K
LED Number	1	1
TOTAL Power	1,2W	4W
Input	350mA	350mA
Weight	0,35 kg	0,35kg
Insulation Class	III	III
IP Code	<b>IP65</b>	<b>IP65</b>
Dimensions	<b>117 x 80 mm</b>	<b>117 x 80 mm</b>
Recessed dimensions	-	-
Body finishing	AL anodized	AL anodized
Diffuser finishing	Matt	Matt

Notes: Driver not included

ILLUMINA	EN4013	EN4014
LED Colour	White 3000K or 4000K	White 3000K or 4000K
LED Number	-	-
TOTAL Power	1,2W	4W
Input	350mA	230Vac
Weight	0,18 kg	0,18kg
Insulation Class	III	III
IP Code	<b>IP65</b>	<b>IP65</b>
Dimensions	<b>117 x 80 mm</b>	<b>117 x 80 mm</b>
Recessed dimensions	-	-
Body finishing	AL anodized	AL anodized
Diffuser finishing	Matt	Matt

Notes: Driver not included  
Option: Custom serigraphy

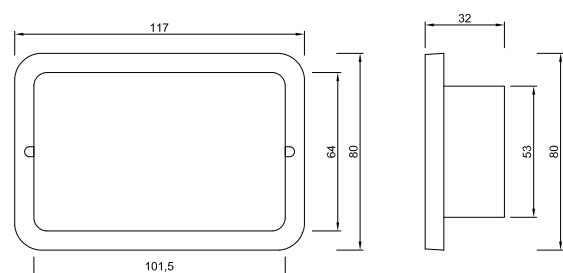
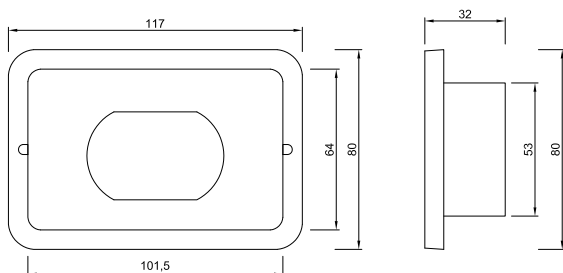



## GIÓ



**Apparecchio a led per installazione a parete, per interni o esterni, senza viti di fissaggio a vista. Corpo in lamiera di acciaio verniciato bianco. Schermo di protezione in PMMA opale o chiaro. Attacco a muro tipo magnetico.**

Led lighting luminaire for wall installation, indoor or outdoor. No screws at sight. Body in steel, white finishing, diffuser in PMMA, matt or clear. Installation with magnet.

GIÓ	EN1200	EN1201
LED Colour	White	White
LED Type	Power led	Power led
LED Number	-	-
LED Power	10W Up + 10W down	15W Up + 15W down
Total Power	20W	30W
Input	230Vac	230Vac
Weight	1,2 kg	1,5 kg
Lens	-	-
Insulation Class	I	I
IP Code	<b>IP65</b>	<b>IP65</b>
Dimensions	<b>200x110x70 mm</b>	<b>200x110x70 mm</b>
Body	White steel	White steel
Diffuser	Opal PMMA	Opal PMMA

Notes: On request only Up or Down, dimmable

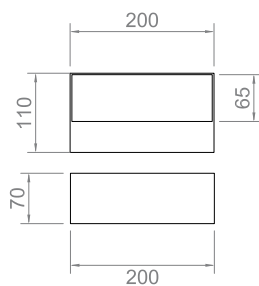

## BIG GIÓ



**Apparecchio a led per installazione a parete, per interni o esterni, senza viti di fissaggio a vista. Corpo in lamiera di acciaio verniciato bianco. Schermo di protezione in PMMA opale o chiaro. Attacco a muro tipo magnetico.**

Led lighting luminaire for wall installation, indoor and outdoor. No screws at sight. Body in steel, white finishing, diffuser in PMMA, matt or clear. Installation with magnet.

BIG GIÓ	EN1204
LED Colour	White
LED Type	Power led
LED Number	-
LED Power	20W Up + 20W down
Total Power	40W
Input	230Vac
Weight	2 kg
Lens	-
Insulation Class	I
IP Code	<b>IP65</b>
Dimensions	400x110x70 mm
Body	White steel
Diffuser	Opal PMMA

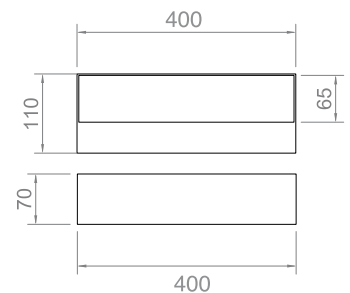

## INSTALLATION BOX



CODE	dimensions	PLASTIC	Installation box for
ENC013	∅ 40x80 mm	LUCE - NETTO - LUNA - RAGGIO - DADO 5	
ENC008	∅ 75x100 mm	MAX 3 - UFO - DADO 10	
ENC009	∅ 160x100 mm	OTERO	
ENC020	∅ 32x60 mm	BETA	
ENC503	503 box	ILLUMINA	
ENC065	∅ 65 box	GOCCIA	

CODE	dimensions	ALUMINIUM	Installation box for
ENC012	∅ 20x40 mm	PUNTO	
ENC013	∅ 40x80 mm	LUCE - NETTO - LUNA - RAGGIO - DADO 5	
ENC018	∅ 75x100 mm	MAX 3 - UFO - DADO 10	
-			
STAINLESS STEEL		Installation box for	
ENC004	∅ 50x65 mm	IDEA	

## LED DRIVERS

CODE	description		IP rate	dimensions
GI4150	3W	350mA cc	IP66	36x26x22 mm
LT6350	6W	350mA cc	IP67	45x45x25 mm
LT12350	12W	350mA cc	IP67	81x40x23 mm
DX17350	17W	350mA cc	IP67	118x32x20 mm
LT18350	18W	350mA cc	IP67	133x40x30,5 mm
LT2500	2W	500mA cc	IP67	32x34x25 mm
LT6500	6W	500mA cc	IP67	45x45x25 mm
LT12500	12W	500mA cc	IP67	81x40x23 mm
LT26500	26W	500mA cc	IP67	133x40x30,5 mm
DR62850	9W	700mA cc	IP44	∅49x20 mm
LT12700	12W	700mA cc	IP67	80x40x23 mm
LT18700	18W	700mA cc	IP67	133x40x31 mm
LT36700	36W	700mA cc	IP67	133x40x31 mm
RO61700	61W	700mA cc	IP64	70x57x32 mm
PH75700	75W	700mA cc	IP67	242x59x40 mm
HE100700	100W	700mA cc	IP65	234x53x35 mm
PH150700	150W	700mA cc	IP67	242x59x40 mm
PH150700D	150W	700mA cc	IP67	242x59x40 mm
LT481050	48W	1050mA cc	IP67	133x40x30,5 mm
VS601050	60W	1050mA cc	IP67	201x60x34 mm
HE1001050	100W	1050mA cc	IP67	190x52x37 mm
HE601400	60W	1400mA cc	IP65	162,5x42x32 mm

CODE	description		IP rate	dimensions
DX1812	18W	12Vdc	12Vdc	140x30x20 mm
DR0073	30W	12Vdc	12Vdc	235x127x58 mm
DR0074	60W	12Vdc	12Vdc	178x70x5x45 mm
DR0075	100W	12Vdc	12Vdc	240x70x5x44mm
DR0076	150W	12Vdc	12Vdc	235x127x58 mm
LT1224	12W	24Vdc	IP67	84x35x23 mm
DR7300	30W	24Vdc	IP66	235x127x58 mm
DX6024	60W	24Vdc	IP67	162x42,5x32 mm
DR7400	60W	24Vdc	IP66	178x70,5x45 mm
DR7500	100W	24Vdc	IP66	240x70x5x44mm
ET5008	100W	24Vdc	IP67	222x38x38x8 mm
DR7600	150W	24Vdc	IP66	235x127x58 mm
ET5733	150W	24Vdc	IP65	229x68x38,8 mm
LT10024	100W	24Vdc	IP67	230x65x42 mm
LT10048	100W	48Vdc	IP67	230x65x42 mm
SURGE PROTECTOR				
SPD23010K	10kV - 10kA		IP66	32x22x13 mm
SPC23010K	10kV - 10kA		IP66	53x28x27 mm

## RETROFIT



Enled studia e realizza il retrofit a LED di apparecchi di illuminazione con sorgenti a scarica di cui si vuole conservare il corpo per esigenze estetiche e funzionali. Le principali applicazioni sono:

**Lanterne classiche - Scatolati ad incasso - Apparecchi customizzati - Apparecchi decorativi**

Enled projects and develop LED retrofit for standard discharge luminaires when keeping the old body is necessary for functional or aesthetical reasons. Main applications are: Classic lanterns - Recessed luminaires - Custom made luminaires - Decorative systems

## LIGHT POLLUTION

I nostri apparecchi di illuminazione a LED sono tutti conformi alle specifiche relative alle Leggi Regionali contro l'inquinamento luminoso e per l'efficientamento energetico.

All of our LEDs luminaires are completely cut-off.

## ENERGY SAVING

Oltre ai normali driver di alimentazione elettronici ON/OFF, Enled propone innovativi sistemi dimmerabili ad alta efficienza per la gestione e il controllo/riduzione della potenza assorbita, in linea con le sempre crescenti esigenze di risparmio energetico. Gli apparecchi possono così essere gestiti in modo dinamico ed intelligente per diventare un'infrastruttura flessibile nei moderni sistemi di illuminazione pubblica delle "smart cities".

Sistemi di dimmerazione per la regolazione di luminosità e dell'assorbimento:

- programmazione fissa a step personalizzabili
- segnale 1-10V o DALI
- GSM o wireless
- onde convogliate

E' sufficiente che la linea di alimentazione sia comandata da un crepuscolare, eliminando così i costi di orologi e regolatori di flusso. Il driver rileva automaticamente la durata della notte dal tempo di presenza di tensione in rete, e aggiorna la sua memoria per eseguire correttamente le funzioni di dimmerazione in base alla stagione in corso.

Over standard switchable LED drivers, Enled offers innovative high efficiency dimmable systems for power control and energy saving. In this way luminaire management is intelligent and dynamic and items can be integrated in a modern and flexible "smart city".

Dimmable systems for power and luminous flux regulation:

- pre-programmed light-steps
- 1-10V or DALI signal
- GSM or wireless
- power line communication

**NVH150C**



**QUEBEC IQV**



**NOVA**



**FUTURA WALL**



**LANTERNA**



**ONDA**



**ALCOR**

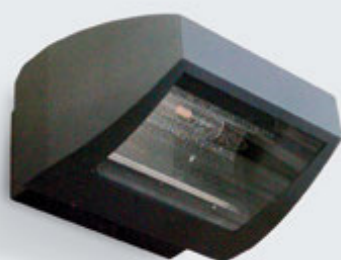

**WALL M150**



**ORION AL4000**





**ORION3 AL4150**



**GALLERIA GSL**



**RAZOR IRT**



**RAZOR IRS**



**ZEUS IZX-A60**



**NK400/A**



## A B

- 53 **BIG GIÓ**
- 28 **BOA industrial**

## C

- 13 **CIGNO**
- 31 **CUBETTO**
- 31 **CUBETTO 2**

## D

- 47 **DADO 5**
- 47 **DADO 10**

## E F

- 7 **FACTOTUM**
- 11 **FALCO**
- 48 **FASCIA**
- 19 **FUTURA**

## G

- 22 **GARDA**
- 29 **GECO**
- 53 **GIÓ**
- 50 **GOCCIA**
- 13 **GRU**

## H I J K

- 11 **IBIS**
- 29 **IGUANA**
- 51 **ILLUMINA**

## L

- 23 **LANCIA**
- 35 **LUCE round**
- 35 **LUCE Q square**
- 37 **LUCE SOFT round**
- 37 **LUCE SOFT Q square**
- 40 **LUCE proiettore**
- 50 **LUNA**

## M

- 37 **MAX 3 SOFT**
- 39 **MAX 3 round**
- 39 **MAX 3 Q square**
- 40 **MAX 3 proiettore**
- 27 **MOSAICO**
- 27 **MOSAICO downlight**

## N

- 49 **NETTO round**
- 49 **NETTO Q square**
- 21 **NIBBIO**

## O

- 15 **ORIOLED**
- 41 **OTERO proiettore**
- 41 **OTERO incasso**

## P

- 51 **PALPEBRA**
- 23 **PIPEDO**
- 33 **PUNTO round**
- 33 **PUNTO Q square**

## Q R

- 44 **RAGGIO 1**
- 44 **RAGGIO 2**
- 44 **RAGGIO 4**

## S

- 48 **SANPIETRINO**
- 30 **SOLE C**
- 30 **SOLE E**

## T U

- 44 **UFO 180°**
- 45 **UFO 1**
- 45 **UFO 2**
- 45 **UFO 4**

## V W Y

- 29 **VARANO**

## Z

- 22 **ZETA 700**
- 22 **ZETA 1000**

- 16 **ORIOLED POLES**
- 17 **FUTURA POLES**

- 54 **INSTALLATION BOX**
- 54 **LED DRIVERS**
- 55 **RETROFIT**

- 56 / 57 **RANGE PRODUCT ENGI srl**



**tel +39 0424 582534**  
**fax +39 0424 587185**  
**www.engi.it**  
**info@engi.it**

by ENGI s.r.l.  
36027 Rosà - Vicenza - Italy  
via Cassola 60

**Tutti i dati e le descrizioni in questo catalogo si intendono forniti a solo titolo informativo e non sono impegnativi per l'azienda produttrice, la quale si riserva il diritto di apportare variazioni e modifiche che si rendessero necessarie per ottenere ulteriori miglioramenti qualitativi dei prodotti.**

All data and descriptions in this catalogue are provided only for information and not binding for the Company, and reserve the right to make necessary changes to improve the quality of its products.

**Vietata la riproduzione anche parziale di testi ed immagini**

It is forbidden to copy texts and/or images.

© ENGI srl



**tel +39 0424 582534**  
**fax +39 0424 587185**  
**[www.engi.it](http://www.engi.it)**  
**[info@engi.it](mailto:info@engi.it)**

---

36027 Rosà - Vicenza - Italy  
via Cassola 60

**E6** EXTERIOR LIGHTING