

Work

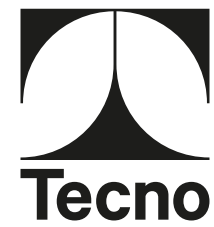

Work



The world of work is in continuous evolution, codes of conduct are changing and behaviours and lifestyles are no longer the same. Tecno interprets these changes by redefining the paradigms of working life in the language of flexibility, personalisation and comfort. Efficient, responsive furnishings that are nonetheless welcoming: our new multifunctional proposals dialogue with the icons in designing the contemporary workplace.

Il mondo del lavoro è in continua evoluzione, i codici si rinnovano, variano i comportamenti e le modalità per vivere gli ambienti. Tecno interpreta questi cambiamenti ritracciando i paradigmi del lavoro con un linguaggio che parla di flessibilità, personalizzazione, comfort. Arredi efficienti, responsive e allo stesso tempo accoglienti: le nuove proposte multifunzionali dialogano con le icone, disegnando lo spazio work contemporaneo.

**Archipelago,
Asymmetrical, AT16,
Aura, Basic, Beta,
Cento, Clavis, D70,
Détabilisation, Graphis,
Hortus, Ianus, IO.T,
Laetitia, Linea, Modus,
Multy, Nomos, P08,
P31, P32, P40, Plau,
Pons, Qualis, Serie 142,
Serie 148, Shift,
Solenoidi, T1 T2, T334
T335, T50, T69, T90,
Todo Modo, Vara, Vela.**

The Tecno office
L'ufficio di Tecno

Workstations 9
Sistemi operativi

Executive 139
Direzionali

Seating 213
Sedute

Upholstered and accessories 259
Imbottiti e complementi

IO.T 350

Versatile, reconfigurable workstations adapt to a variety of organisational needs and evolve over time to respond to the requirements of ever more agile offices. They promote dynamic exchanges and concentrated work by integrating a variety of functions with numerous personalisation options.

Workstations versatili e riconfigurabili diventano strutture in grado di adattarsi a diverse organizzazioni ed evolvere nel tempo per far fronte alle esigenze di uffici sempre più agili. Utili agli scambi dinamici o alla concentrazione individuale, le postazioni integrano diverse funzionalità e offrono numerose opzioni di personalizzazione.

Workstations

Sistemi operativi

Clavis 28

Beta 44

Nomos 68

Graphis 92

Multy 106

Basic 116

Linea 126

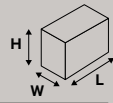

Clavis pag. 28

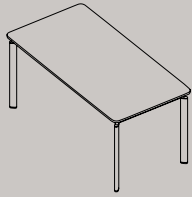

Single desk
Scrivania singola
L×W 140×80 / 160×80 / 180×80 /
200×100 cm, H 74 cm
L×W 55 ¼×31 ½ / 63×31 ½ / 71×31 ½ /
79×39 ½", H 29"

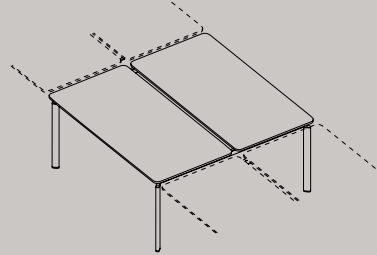

2-person workstation
Postazione doppia contrapposta
L×W 140×164 / 160×164 / 180×164 cm, H 74 cm
L×W 55 ¼×64 ½ / 63×64 ½ / 71×64 ½", H 29"

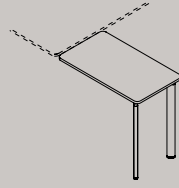

Extension for single desk
Allungo per postazione singola
L×W 84×40 / 84×60 cm, H 74 cm
L×W 33×15 ½ / 33×23 ½", H 29"

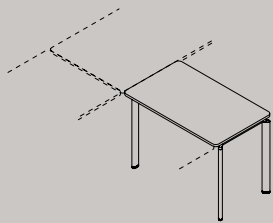

Extension for workstations and desk 200×100 cm / 79×39 ½"
Allungo per postazioni doppie e scrivania 200×100 cm
L×W 100×60 cm, H 74 cm
L×W 39 ½×23 ½", H 29"

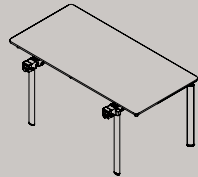

End top
Piano terminale di testa
L×W 164×60 / 164×80 cm, H 74 cm
L×W 64 ¾×23 ½ / 64 ¾×31 ½", H 29"

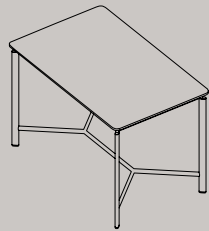

Standing-height work table
Tavolo da lavoro in piedi
L×W 160×100 / 180×100 cm, H 105 cm
L×W 63×39 ½ / 71×39 ½", H 41 ½"

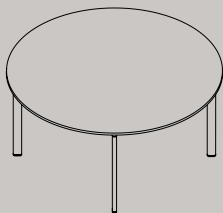

Round meeting table
Tavolo meeting rotondo
Ø 115 / 140 / 170 cm, H 74 cm
Ø 45 ½ / 55 ½ / 67", H 29"

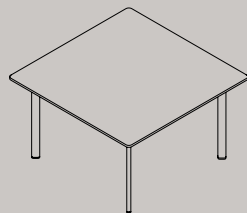

Square meeting table
Tavolo meeting quadrato
L×W 100×100 / 120×120 / 140×140 /
160×160 cm, H 74 cm
L×W 39 ½×39 ½ / 47 ¼×47 ¼ / 55 ½×55 ½ /
63×63", H 29"

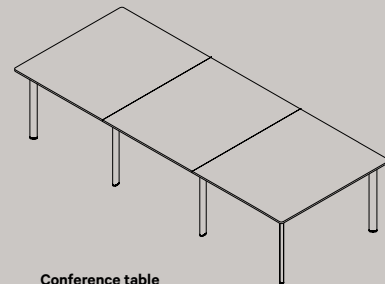

Conference table
Tavolo conference
L×W 263×160 / 303×160 / 385×160 /
508×160 cm, H 74 cm
L×W 103 ½×63 / 119 ½×63 / 151 ½×63 /
200×63", H 29"

Clavis

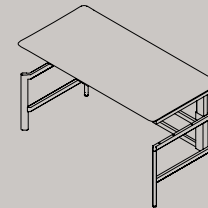

Height-adjustable individual desk
Postazione singola regolabile in altezza
L×W 140×80 / 160×80 / 180×80 cm,
H 68–118 cm
L×W 55 ¼×31 ½ / 63×31 ½ / 71×31 ½",
H 26 ¾–46 ½"

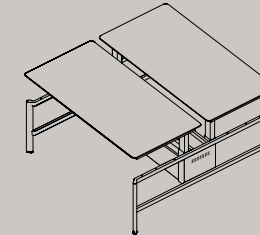

Height-adjustable workstation
Postazione doppia regolabile in altezza
L×W 140×167 / 160×167 / 180×167 cm,
H 68–118 cm
L×W 55 ¼×65 ½ / 63×65 ½ / 71×65 ½",
H 26 ¾–46 ½"

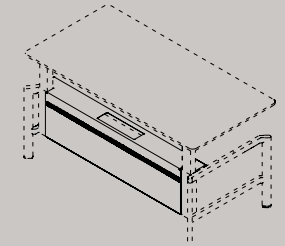

Finishing casing for height-adjustable desk
Carter di finitura per scrivania regolabile in altezza
L 123 / 143 / 163 cm, W 16 cm, H 37 cm
L 48 ½ / 56 ½ / 64 ½", W 6 ¼", H 14 ¾"

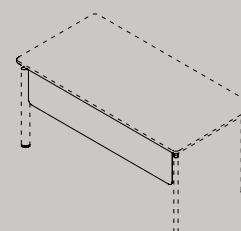

Modesty panel

Lateral modesty panel for desks W:
Modesty panel laterale per scrivanie W:
W 80 / 100 / 163 cm, H 26 cm
W 31 ½ / 39 ½ / 64 ¼", H 10 ¼"

Front modesty panel for desks L:
Modesty panel per scrivanie L:
L 140 / 160 / 180 / 200 cm, H 26 cm
L 55 ¼ / 63 / 71 / 78 ¾", H 10 ¼"

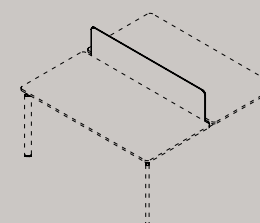

Screen
Schermo

Lateral screen for desks W:
Schermo laterale per scrivanie W:
W 80 / 100 / 163 cm, H 36 / 51 cm
W 31 ½ / 39 ½ / 64 ¼", H 14 ¼ / 20"

Front screen for desks L:
Schermo per scrivanie L:
L 140 / 160 / 180 cm, H 36 / 51 cm
L 55 ¼ / 63 / 71", H 14 ¼ / 20"

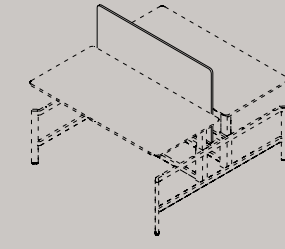

Screen for height-adjustable workstation
Schermo per postazione regolabile in altezza

Front screen for desks L:
Schermo per scrivanie L:
L 140 / 160 / 180 cm, H 78 cm
L 55 ¼ / 63 / 71", H 30 ¾"

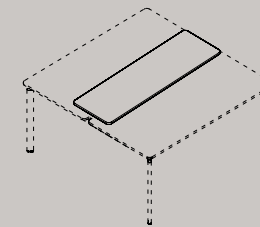

Shared shelf with or without drawers
Mensola condivisa con o senza cassetti
L 140 / 160 / 180 cm, H 7 cm
L 55 ¼ / 63 / 71", H 2 ¾"

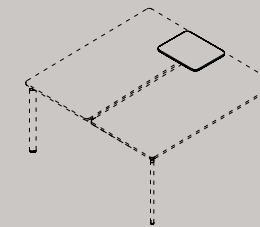

Shared side shelf with or without drawers
Mensola laterale condivisa con o senza cassetti
L 37 cm, W 47 cm, H 7 cm
L 14 ¾", W 18 ½", H 2 ¾"

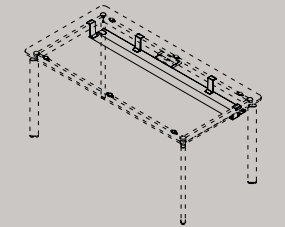

Cable tray for desks
Canalina per piani
L 123 / 143 / 163 / 183 cm, W 14 cm, H 2 cm
L 48 ½ / 56 ½ / 64 ¼ / 72", W 5 ½", H ¾"

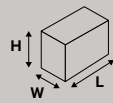

Clavis

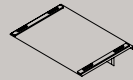

Single shelf
Mensola singola
L 37 cm, W 47 cm, H 7 cm
L 14 ½", W 18 ½", H 2 ¾"

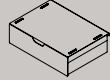

Drawer
Cassetto
L 37 cm, W 47 cm, H 7 cm
L 14 ½", W 18 ½", H 2 ¾"



Clothes hook
Gancio appendiabiti
L 5 cm, W 8 cm, H 8 cm
L 2", W 3 ¼", H 3 ¼"

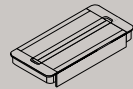

Top access
L 20 cm, W 10 cm
L 8", W 4"



Socket above top (2 Schuko - 2 USB - 2 RJ45)
Presse sopra piano (2 Schuko - 2 USB - 2 RJ45)
L 21 cm, W 9 cm, H 16 cm
L 8 ¼", W 3 ½", H 6 ½"

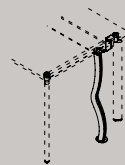

Cable conduit sleeve
Calza salita cavi
L 5 cm, W 6 cm, H 35 / 160 cm
L 2", W 2 ½", H 13 ¾ / 63"

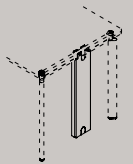

Cable conduit casing
Carter salita cavi
L 14 cm, W 5 cm, H 70 cm
L 5 ½", W 2", H 27 ½"

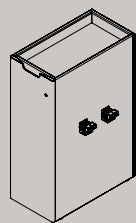

Storage unit with 2 shelves
Contenitore a 2 ripiani
L 42 cm, W 80 cm, H 74 / 105 cm
L 16 ½", W 31 ½", H 29 ¼ / 41 ½"

Storage unit with 3 shelves
Contenitore a 3 ripiani
L 42 cm, W 80 cm, H 120 cm
L 16 ½", W 31 ½", H 47 ¼"

Beta pag. 44

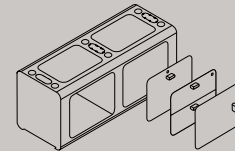

Single or double-sided backbone with open compartment, drawer, door or flap
Backbone mono o bifacciale con vani a giorno, cassetti, ante o sportelli
L 120,5 cm, W 46 cm, H 53 cm
L 47 ½", W 18", H 21"



2-way backbone connecting element
Elemento di connessione per backbone a 2 vie
L 48 cm, W 31 cm, H 53 cm
L 19", W 12 ¼", H 21"

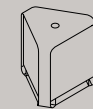

3-way backbone connecting element
Elemento di connessione per backbone a 3 vie
L 48 cm, W 55 cm, H 53 cm
L 19", W 21 ¾", H 21"

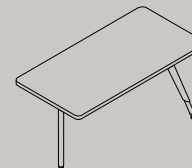

Basic desk for backbone with fixed or adjustable height
Scrivania basic per backbone ad altezza fissa o regolabile
L×W 160×80 / 180×80 / 180×100 cm, H 75 / 65-85 cm
L×W 63×31 ½ / 71×31 ½ / 71×39 ½", H 29 ½ / 25 ½-33 ½"

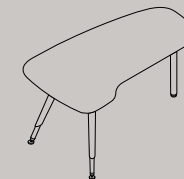

Semi-evolved desk for backbone with fixed or adjustable height
Scrivania semievoluta per backbone ad altezza fissa o regolabile
L×W 160×100 / 175×100 cm, H 75 / 65-85 cm
L×W 63×39 ½ / 69×39 ½", H 29 ½ / 25 ½-33 ½"

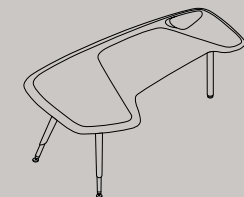

Evolved desk for backbone with fixed or adjustable height
Scrivania evoluta per backbone ad altezza fissa o regolabile
L×W 195×100 cm, H 75 / 65-85 cm
L×W 77×39 ½", H 29 ½ / 25 ½-33 ½"

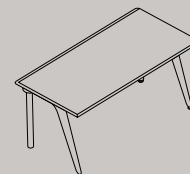

Free-standing desk
Scrivania free-standing
L×W 140×80 / 160×80 cm, H 75 cm
L×W 55 ¼×31 ½ / 63×31 ½", H 29 ½"

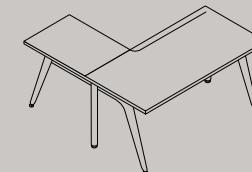

Free-standing desk with extension
Scrivania free-standing con allungo
L×W 160×162,5 / 180×162,5 cm, H 75 cm
L×W 63×64 / 71×64", H 29 ½"

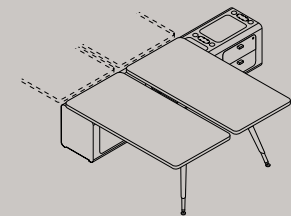

2-person workstation
Postazione doppia contrapposta
L×W 160×166 / 180×166 cm, H 75 cm
L×W 63×65 ½ / 71×65 ½", H 29 ½"

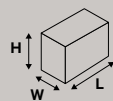

Beta

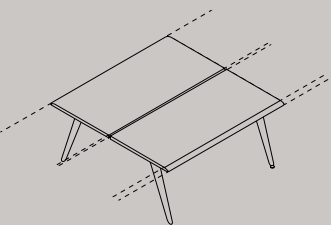

Free-standing 2-person workstation
Postazione doppia contrapposta free-standing
L×W 140×163 / 160×163 cm, H 75 cm
L×W 55 ¼×64 ¼ / 63×64 ¼", H 29 ½"

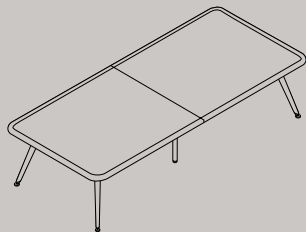

Conference table
Tavolo conference
L×W 318,5×140 / 311×163 cm, H 75 cm
L×W 125 ½×55 / 122 ½×64 ¼", H 29 ½"

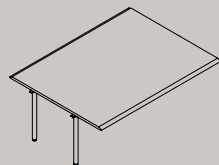

Intermediate top for conference table
Piano intermedio per tavolo conference
L×W 160×140 / 160×163 / 180×163 cm, H 75 cm
L×W 63×55 / 63×64 ¼ / 71×64 ¼", H 29 ½"

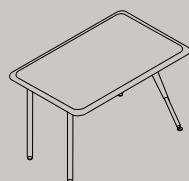

High meeting table for backbone
Tavolo meeting alto per backbone
L×W 160×100 / 180×100 / 200×100 cm, H 110 cm
L×W 63×39 ½ / 71×39 ½ / 79×39 ½", H 43 ½"

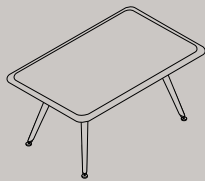

Rectangular meeting table
Tavolo meeting rettangolare
L×W 160×100 / 160×140 / 180×100 /
200×100 cm, H 75 cm
L×W 63×39 ½ / 63×55 / 71×39 ½ /
79×39 ½", H 29 ½"

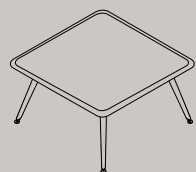

Square meeting table
Tavolo meeting quadrato
L×W 140×140 / 160×160 cm, H 75 cm
L×W 55×55 / 63×63", H 29 ½"



Round meeting table
Tavolo meeting tondo
Ø 140 / 160 cm, H 75 cm
Ø 55 / 63", H 29 ½"

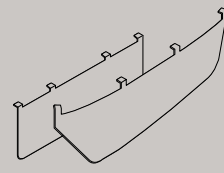

Rectangular modesty panel
Modesty panel rettangolare
L 100 cm, H 37 cm
L 39 ½", H 14 ½"

Evolved modesty panel
Modesty panel evoluto
L 118 cm, H 41,5 cm
L 46 ½", H 16 ½"

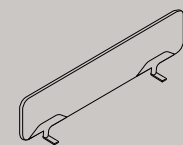

Screen
Schermo
L 120 / 140 / 160 / 180 cm, H 31,5 / 35 cm
L 47 ¼ / 55 / 63 / 71", H 12 ½ / 13 ¾"

Beta

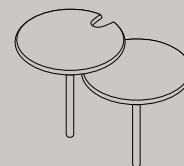

Round coffee table for backbone with or without recess for cables
Tavolino rotondo per backbone con o senza svasatura per cavi
Ø 70 cm, H 65 cm
Ø 27 ½", H 25 ¾"

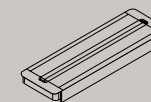

Top access
Top access su piano
L 30 cm, W 10 cm
L 12", W 4"



External top access
Top access esterno
L 40 cm, W 23 cm, H 17 cm
L 15 ¾", W 9", H 6 ¾"

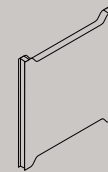

Cable conduit casing
Carter salita cavi
L 52 cm, W 5 cm, H 62 cm
L 20 ½", W 2", H 24 ¾"



Wiring ring
Anello passacavi

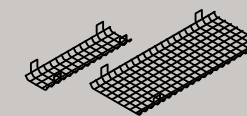

Cable tray
Canalina
L 71 / 106 cm, W 20 / 45 cm, H 9 cm
L 28 / 41 ¾", W 8 / 17 ¾", H 3 ¾"



Seat cushion for backbone
Cuscino seduta per backbone
L 41 cm, W 28 cm, H 3 cm
L 16 ¼", W 11", H 1 ¾"

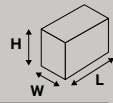

Nomos Table pag. 68

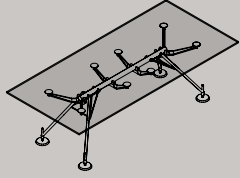

Rectangular table
Tavolo rettangolare

L×W 160×80 / 160×100 / 180×80 /
180×90 / 180×100 / 200×100 /
220×100 / 240×100 / 280×100 cm,
H 65 / 72 cm
L×W 63×31 ½ / 63×39 ½ / 71×31 ½ /
71×35 ½ / 71×39 ½ / 78 ¼×39 ½ /
86 ½×39 ½ / 94 ½×39 ½ / 110 ¼×39 ½",
H 25 ½ / 28 ½ "

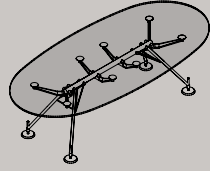

Oval table
Tavolo ovale

L×W 240×110 cm, H 65 / 72 cm
L×W 94 ½×43 ½", H 25 ½ / 28 ½ "

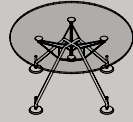

Round table
Tavolo rotondo

Ø 120 / 140 cm, H 65 / 72 cm
Ø 47 ¼ / 55 ¼", H 25 ½ / 28 ½ "

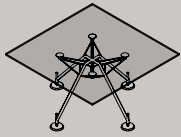

Square table

Tavolo quadrato
L×W 120×120 cm, H 65 / 72 cm
L×W 47 ¼×47 ¼", H 25 ½ / 28 ½ "

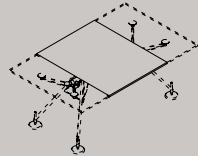

Leather blotter

Sottomano in pelle
L×W 100×100 cm
L×W 39 ½×39 ½ "

Nomos System pag. 68

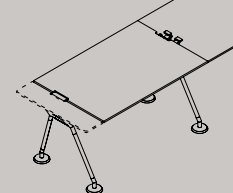

Single desk

Scrivania singola
L×W 80×60 / 120×60 / 160×60 /
80×80 / 120×80 / 160×80 /
80×100 / 120×100 / 160×100 /
80×120 / 120×120 / 160×120 cm, H 72 cm
L×W 31 ½×23 ¾ / 47 ½×23 ¾ / 63×23 ¾ /
31 ½×31 ½ / 47 ½×31 ½ / 63×31 ½ /
31 ½×39 ½ / 47 ½×39 ½ / 63×39 ½ /
31 ½×47 ½ / 47 ½×47 ½ / 63×47 ½", H 28 ½ "

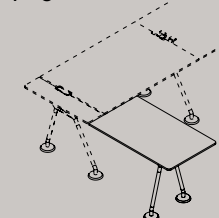

Extension

Allungo
L×W 100×60 / 140×60 cm, H 72 cm
L×W 39 ½×23 ¾ / 55 ¼×23 ¾", H 28 ½ "

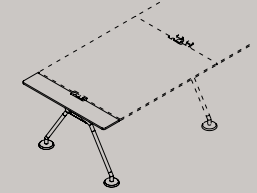

End top

Piano terminale
L×W 20×60 / 20×80 / 20×100 /
20×120 / 40×160 cm, H 72 cm
L×W 7 ¾×23 ¾ / 7 ¾×31 ½ / 7 ¾×39 ½ /
7 ¾×47 ½ / 15 ¼×63", H 28 ½ "

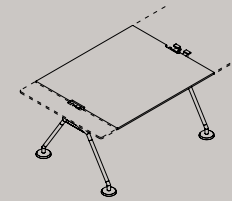

2-person workstation

Postazione doppia contrapposta
L×W 160×160 cm, H 72 cm
L×W 63×63", H 28 ½ "

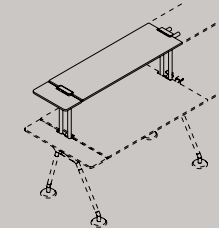

Shelf

Mensola
L×W 160×40 cm, H 39 / 72 cm
L×W 63×15 ¾", H 15 ½ / 28 ½ "

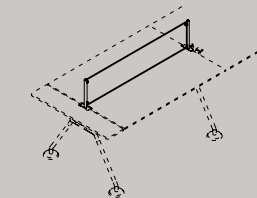

Screen

Schermo
L 160 cm, H 35 cm
L 63", H 13 ¾ "

Shelf end
Terminale mensola
L×W 20×40 cm
L×W 7 ¾×15 ¾ "

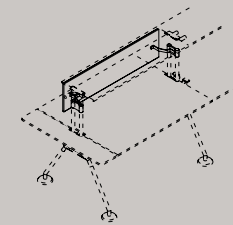

Reception panel

Divisorio reception
L 160 cm, H 30 cm
L 63", H 11 ¾ "

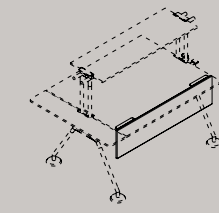

Modesty panel

L 160 cm, H 30 cm
L 63", H 11 ¾ "

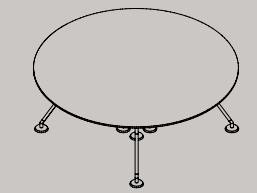

Round meeting table

Tavolo meeting rotondo
Ø 200 cm, H 72 cm
Ø 78 ¾", H 28 ½ "

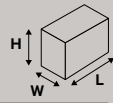

Nomos System

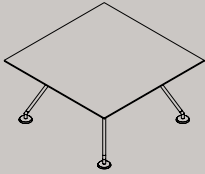

Square meeting table
Tavolo meeting quadrato
L×W 140×140 / 160×160 cm, H 72 cm
L×W 55 ¼×55 ¼ / 63×63", H 28 ½"

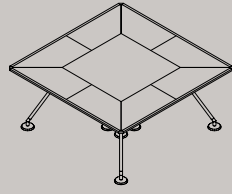

Square meeting table
Tavolo meeting quadrato
L×W 160×160 / 200×200 cm, H 72 cm
L×W 63×63 / 78 ¾×78 ¾", H 28 ½"

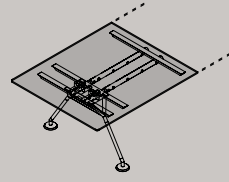

Rectangular end top for meeting table
Piano terminale rettangolare per tavolo meeting
L×W 140×120 / 160×120 / 180×120 /
200×120 / 160×140 / 200×140 cm, H 72 cm
L×W 55 ¼×47 ¼ / 63×47 ¼ / 70 ¾×47 ¼ /
78 ¾×47 ¼ / 63×55 ¼ / 78 ¾×55 ¼", H 28 ½"

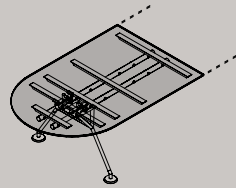

Semi-circular end top for meeting table
Piano terminale semicircolare per tavolo meeting
L×W 183×120 / 203×120 / 183×140 /
223×140 cm, H 72 cm
L×W 72×47 ¼ / 80×47 ¼ / 72×55 ¼ /
87 ¼×55 ¼", H 28 ½"

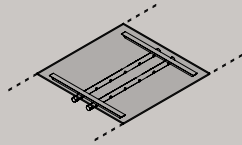

Intermediate top for meeting table
Piano intermedio per tavolo meeting
L×W 120×140 / 160×140 cm, H 72 cm
L×W 47 ¼×55 ¼ / 63×55 ¼", H 28 ½"

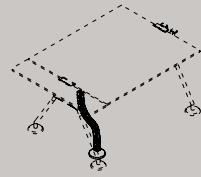

Flexible wiring duct
Vertebra salita cavi
H 72 cm
H 28 ½"

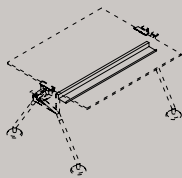

Cable tray
Canalina
L 80 / 120 / 160 cm
L 31 ¼ / 47 ¼ / 63"

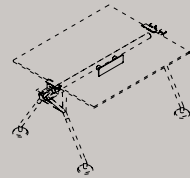

Cable winder
Avvolgifilo

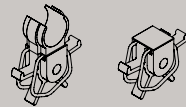

Wiring handler
Portacavi

Graphis pag. 92

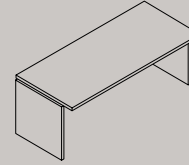

Single desk with or without wiring grommet caps
Postazione singola con o senza tappi passa cavi
L×W 120×65 / 140×65 / 160×65 /
180×65 / 140×80 / 160×80 /
180×80 / 200×80 / 200×100 cm, H 72 cm
L×W 47 ¼×25 ¼ / 55 ¼×25 ¼ / 63×25 ¼ /
71×25 ¼ / 55 ¼×31 ¼ / 63×31 ¼ /
71×31 ¼ / 78 ¾×31 ¼ / 78 ¾×39 ¼", H 28 ½"

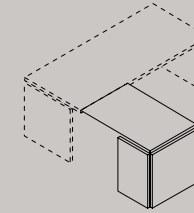

Extension for single desk
Allungo per postazione singola
L×W 80×65 / 100×65 cm, H 72 cm
L×W 31 ¼×25 ¼ / 39 ¼×25 ¼", H 28 ½"

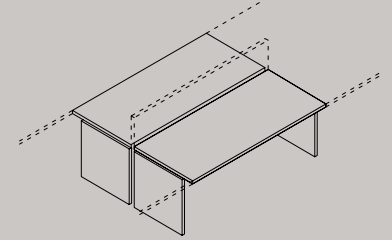

2-person workstation
Postazione doppia contrapposta
L×W 160×165 / 180×165 cm, H 72 cm
L×W 63×63 / 71×63", H 28 ½"

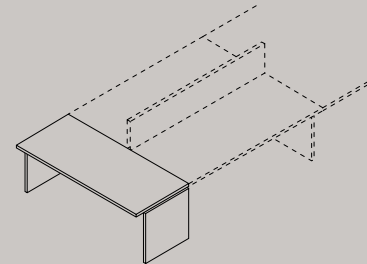

End top
Piano terminale di testa
L×W 156×65 / 186×80 cm, H 72 cm,
L×W 61 ¼×25 ¼ / 73 ¼×31 ¼", H 28 ½"

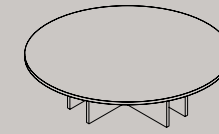

Round meeting table
Tavolo meeting rotondo
Ø 120 / 140 cm, H 72 cm
Ø 47 ¼ / 55 ¼", H 28 ½"

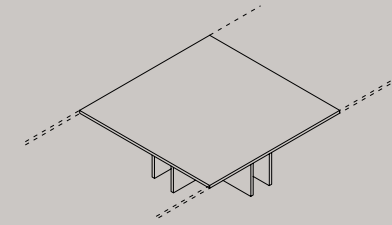

Square meeting table
Tavolo meeting quadrato
L×W 120×120 / 140×140 cm, H 72 cm
L×W 47 ¼×47 ¼ / 55 ¼×55 ¼", H 28 ½"

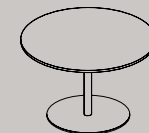

Height-adjustable round table
Tavolo rotondo regolabile in altezza
Ø 90 cm, H 66–100 cm
Ø 35 ¼", H 26–39 ¼"

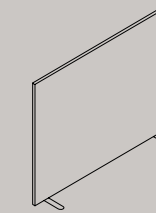

Floor-standing panel
Pannello da terra
L 65 / 80 / 140 / 160 / 180 cm, H 107,5 / 157,5 cm
L 25 ¼ / 31 ¼ / 55 ¼ / 63 / 71", H 42 ¼ / 62"

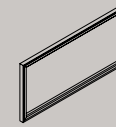

Screen
Schermo
L 65 / 80 / 120 / 140 / 160 / 180 cm, H 39,5 cm
L 25 ¼ / 31 ¼ / 47 ¼ / 55 ¼ / 63 / 71", H 15 ½"

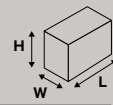

Graphis

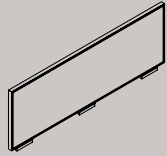

Screen for central cable tray
Schermo per canalina centrale
L 60 / 120 / 160 / 180 cm, H 35,5 cm
L 23 ½ / 47 ½ / 63 / 71", H 14"

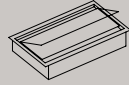

Top access
L 26 cm, W 12 cm
L 10 ¼", W 4 ½"



Flexible wiring duct
Vertebra salita cavi
H 72 cm
H 28 ½"

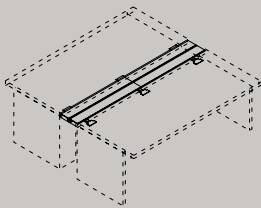

Central cable tray
Canalina centrale
L 160 / 180 cm, W 26 cm
L 63 / 71", W 10 ¼"

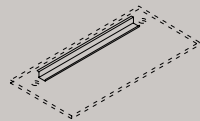

Cable tray
Canalina
L 60 / 80 / 100 / 120 / 140 / 160 cm, W 12 cm
L 23 ½ / 31 ½ / 39 ½ / 47 ½ / 55 ½ / 63", W 4 ¾"

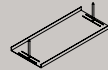

Cable tray
Canalina
L 40 / 60 cm, W 26 cm, H 11 cm
L 15 ½ / 23 ¾", W 10 ¼", H 4 ½"

Multy pag. 106

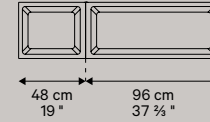

Desk acoustic panel
Pannello divisorio basso
L 144 cm, W 4,6 cm, H 40 cm
L 56 ¾", W 1 ¾", H 15 ¾"

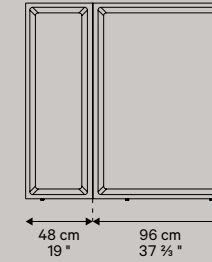

Floor acoustic panel
Pannello divisorio alto
L 144 cm, W 4,6 cm, H 140 cm
L 56 ¾", W 1 ¾", H 55 ¾"

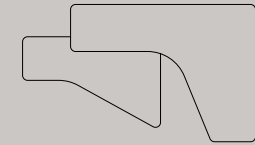

Desk tops
Piani di lavoro
L 140×190 cm, W 92×140 cm
L 55 ¼×74 ¾", W 36 ¼×55 ¼"

Work tops can be assembled at several heights along the profile of the panels
Il piano può essere montato a diverse altezze lungo il profilo dei pannelli

Multy accessories:

- Pair of feet for desk screens
- Floor stabilising feet
- Pair of clamps for panel hooking on the work tops
- Blocking system for free-standing panels
- Terminal upright for superimposed panels
- Joint kit for superimposed panels
- Shelf
- Clothes hook

Accessori Multy:

- Kit piedi di appoggio per pannello da tavolo
- Kit piedi stabilizzatori da terra
- Coppia di morsetti per aggancio del pannello sul piano di lavoro
- Staffette di bloccaggio
- Montante terminale per pannelli sovrapposti
- Kit di giunzione per pannelli sovrapposti
- Mensola
- Appendiabiti

Basic pag. 116

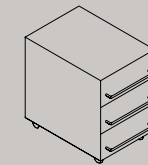

Drawer unit
Cassettiera
L 40 cm, W 56 cm, H 56 cm
L 15 ½", W 22", H 22"

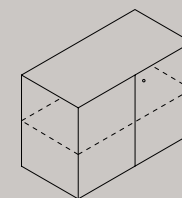
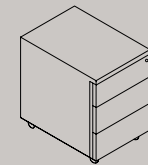

Storage unit with doors and lock with one shelf
Contenitore con ante e serratura a un ripiano
L 80 cm, W 45 cm, H 72 cm
L 80 cm, W 45 cm, H 100 cm
L 31 ½", W 17 ¾", H 28 ½"
L 31 ½", W 17 ¾", H 39 ½"

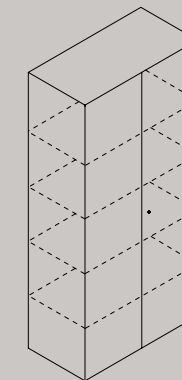

Storage unit with doors and lock with 3 or 4 shelves
Contenitore con ante e serratura a 3 o 4 ripiani
L 80 cm, W 45 cm, H 158 cm
L 80 cm, W 45 cm, H 213 cm
L 31 ½", W 17 ¾", H 62"
L 31 ½", W 17 ¾", H 83 ¾"

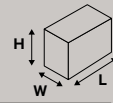

Linea pag. 126

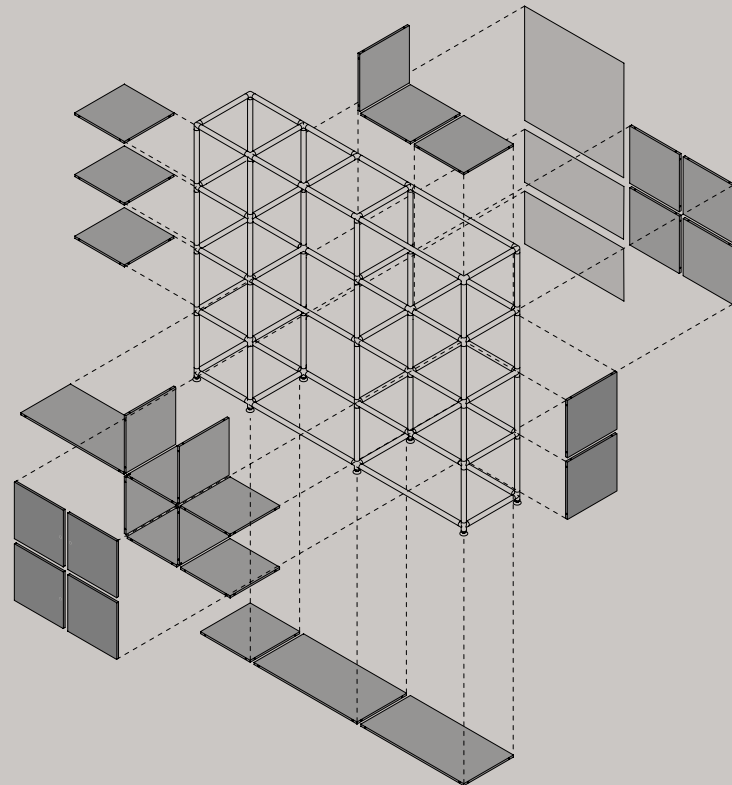
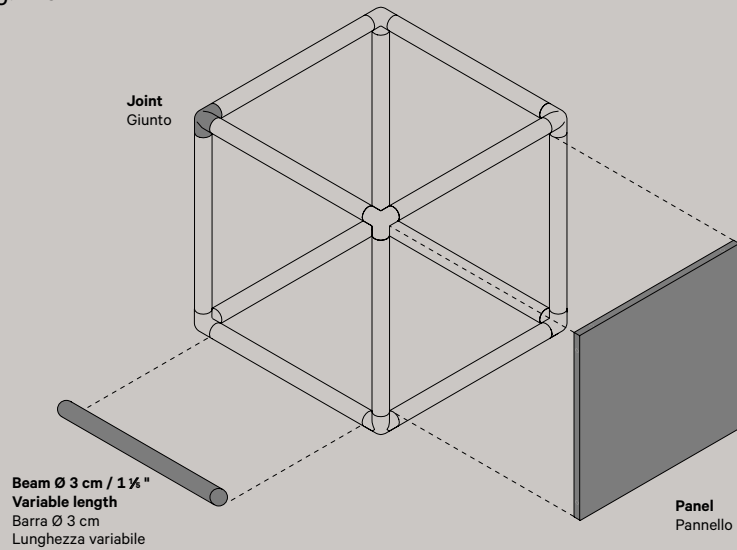

Linea

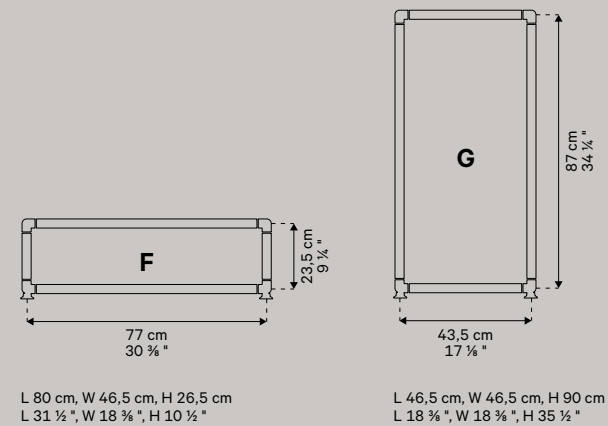
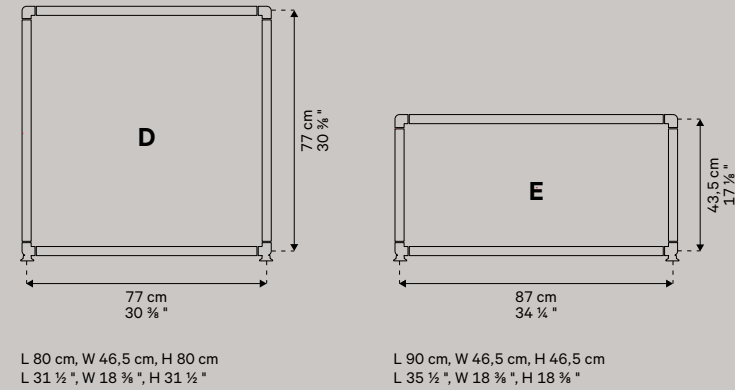
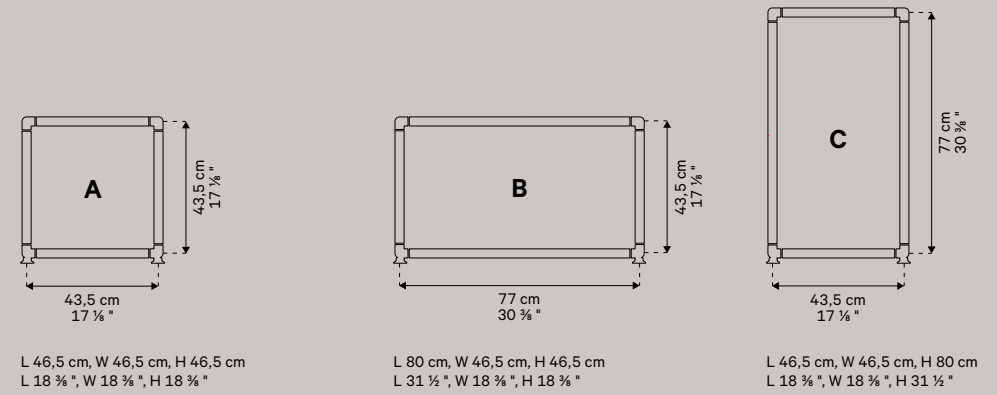

- The total standard depth (W) is 46,5 cm / 18 3/8" with a centre distance of 43,5 cm / 17 1/8"
- Adjustable feet Ø 4,5 cm / 1 3/8", H 1,5 cm / 3/8"
- Compartment with top-hinged or bottom-hinged flap door available for structures: B
- Compartment with low drawers or file drawer available for structures: A, B, F
- Compartment with door available for structures: A, B, G
- Basis modules: for technical and aesthetic definition of the layout please refer to Tecno official product configurator software.

- La profondità (W) totale standard è di 46,5 cm e con interasse di 43,5 cm
- Piedini regolabili Ø 4,5 cm, H 1,5 cm
- Vano con ribaltina a salire o scendere disponibile per strutture: B
- Vano con 2 cassetti bassi o 1 classificatore disponibile per strutture: A, B, F
- Vano con anta disponibile per strutture: A, B, G
- Moduli base: per definizione tecnica ed estetica del layout fare riferimento al configuratore ufficiale Tecno

Clavis 28

Beta 44

Nomos 68

Graphis 92

Multy 106

Basic 116

Linea 126

Clavis

Design:
Daniele del Missier, Centro Progetti Tecno
 2016

The first series of work tables with *tool-free* assembly is the result of thinking about the idea of flexibility: since the link between individual space and work environment is changing, then products must be fully reconfigurable over time. The patented joint and a series of modular components make the table easy to build, disassemble and combine with others: the workstation can be adapted in relation to individual requirements and structural, dimensional, typological and professional changes in the workplace. The tables can also be equipped with a wide range of optional accessories, for a flexible, highly customisable workspace system, which can also be connected with I.O.T. technology.

Il primo programma di tavoli da lavoro con assemblaggio *tool-free* è il risultato di una riflessione sul tema della flessibilità: se cambia il rapporto tra lo spazio individuale e l'ambiente di lavoro è importante che i prodotti prevedano la possibilità di essere riconfigurabili. Il giunto brevettato e una serie di componenti modulari permettono al tavolo di comporsi, scomporsi e aggregarsi facilmente: la workstation può essere così adattata in base alle esigenze individuali e ai cambiamenti strutturali, dimensionali, tipologici o professionali dello spazio. Una vasta gamma di accessori opzionali consente di equipaggiare i tavoli rendendo il sistema flessibile e ampiamente personalizzabile, oltre che digitale grazie alla tecnologia I.O.T.





The frame is composed of a longitudinal element, a transverse element, a single or shared leg and top: these basic components can be repeated in a modular way to yield unlimited layouts.

La struttura è formata da elemento longitudinale, elemento trasversale, gamba singola o condivisa e piani: queste componenti base, ripetendosi in modo modulare, permettono di comporre infinite soluzioni di layout.

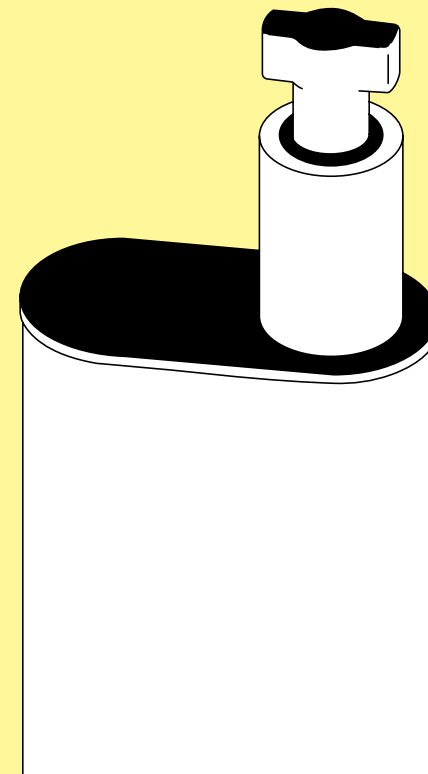
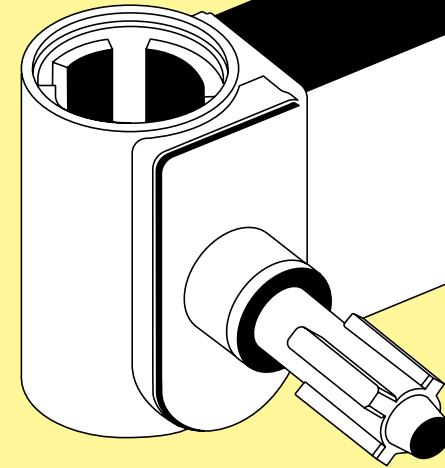
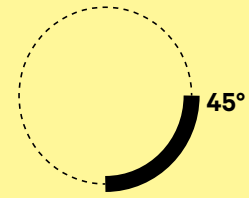

The joint is the heart of the design: the insertion and the 45° rotation of the elements permit quick and easy frame assembly, while the top is secured by special magnetic retainers.

Il giunto a innesto è il cuore del progetto: l'innesto e la rotazione a 45° degli elementi strutturali garantiscono un facile e veloce assemblaggio del telaio, mentre il piano è ancorato tramite speciali agganci magnetici.

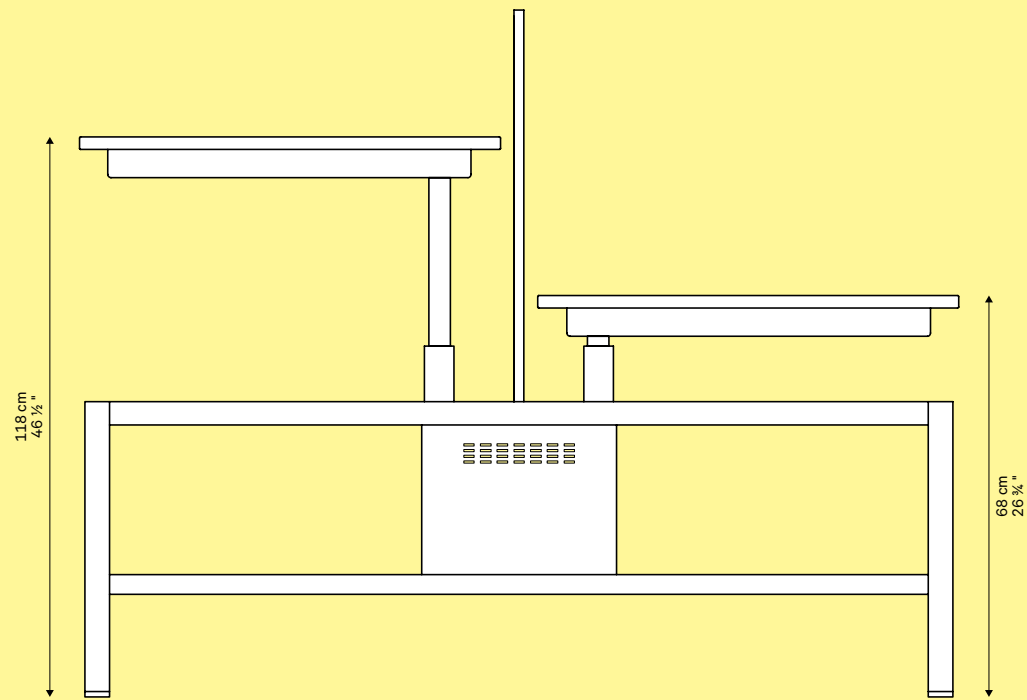

To satisfy all possible working requirements, Clavis is available in different heights or with progressive height adjustment.

Per rispondere a tutti i modi di lavorare, Clavis è disponibile con diverse altezze del piano o con regolazione progressiva dell'altezza.





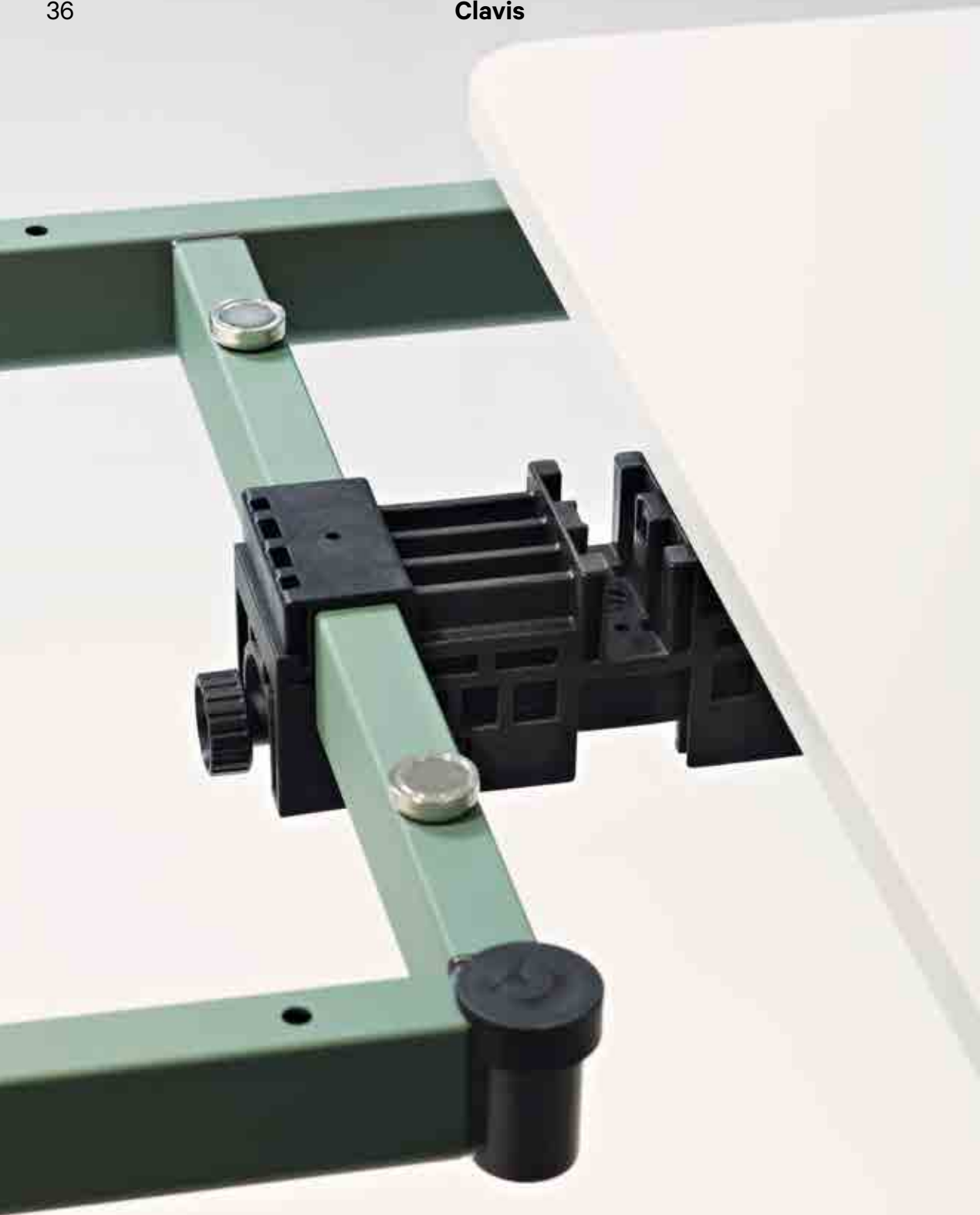

The universal clamp is used to equip the table with a series of multifunctional accessories, thus further expanding the personal configuration and transformation options.

Il morsetto universale permette di equipaggiare i tavoli con una serie di accessori multifunzionali, confermando le caratteristiche di un sistema liberamente configurabile, personalizzabile e trasformabile.







Beta

Design:
Pierandrei Associati
2009

The organically styled workstation system, conceived to give new form to the workspace, adapts to the behaviour of its users and evolves over time. More than a mere rigid system, Beta is structured as an organism following a generative logic of space and can be equipped with I.O.T. The design is based on 3 components: the backbone, desks and accessories create unlimited configuration options and a contemporary approach to usability. With a view to continual evolution, the free-standing and desk versions implement a horizontal organisation which is intentionally non-hierarchical.

Sistema di postazioni lavoro dalla linea organica, pensato per dare nuova forma allo spazio, adattarsi ai comportamenti delle persone ed evolvere nel tempo. Più che un sistema rigido, Beta è strutturato come un vero e proprio "organismo" nato con una logica generativa degli spazi e può essere dotato di I.O.T. Il progetto è basato su 3 componenti: backbone, scrivanie e accessori creano infinite possibilità di configurazione e fruibilità introducendo un approccio contemporaneo. Nell'ottica di continua evoluzione, le versioni free-standing e desk implementano un'organizzazione orizzontale volutamente non gerarchica.



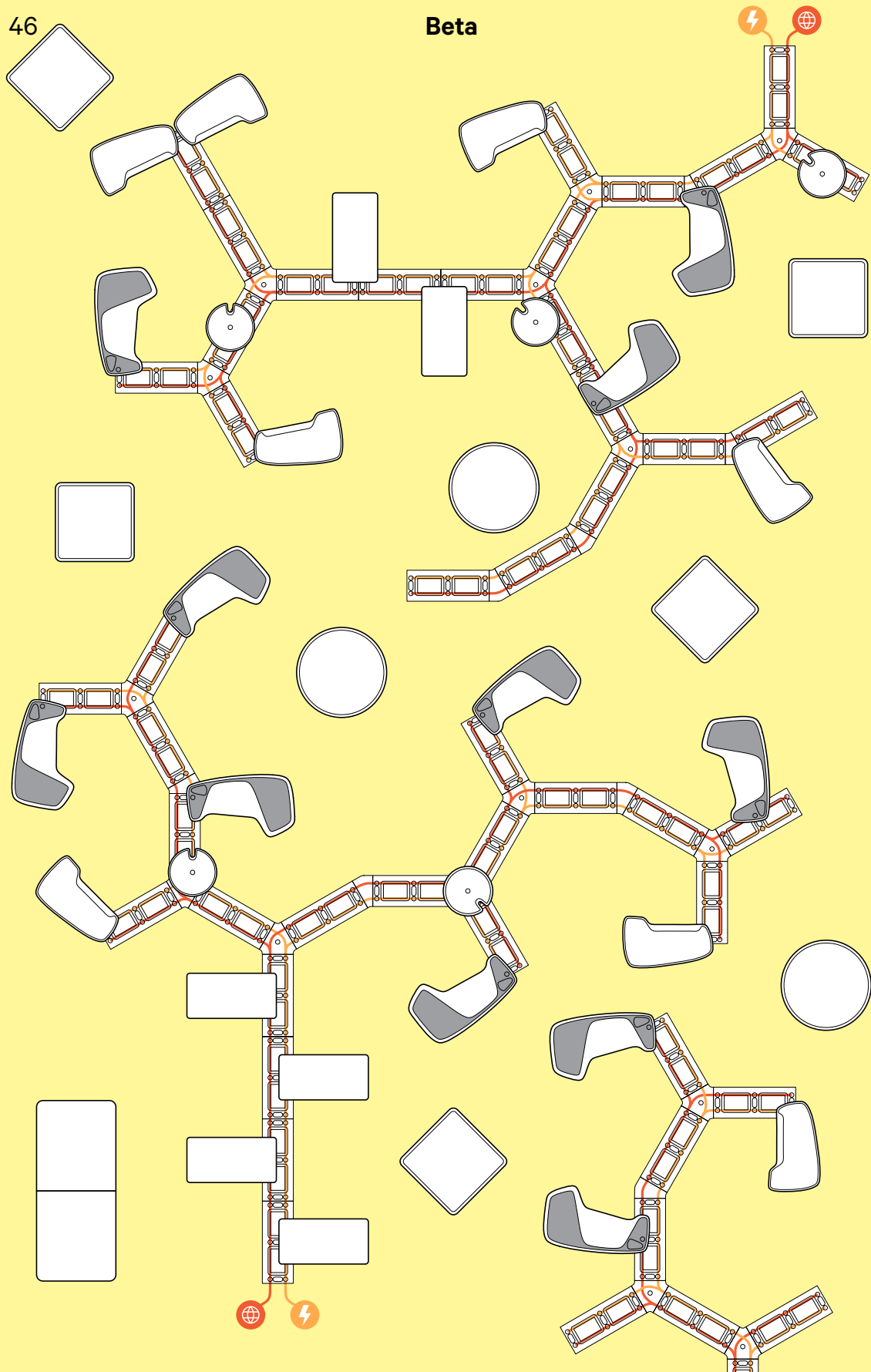

Single configuration
Configurazione singola

3,4 m²

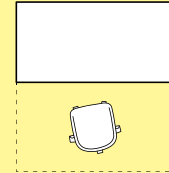

3,3 m²

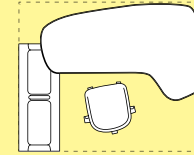

Double configuration
Configurazione doppia

6,3 m²



7,0 m²

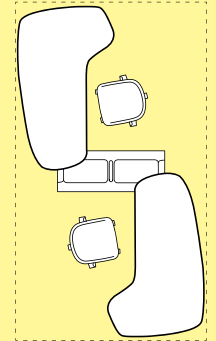

Triple configuration
Configurazione tripla

16,3 m²

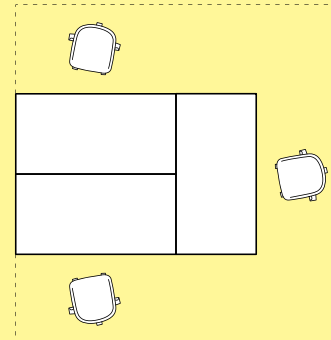

16,5 m²

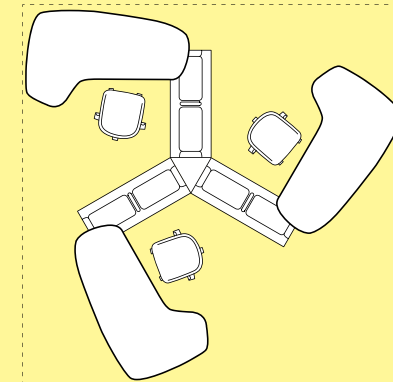

Quadruple configuration
Configurazione quadrupla

13,7 m²

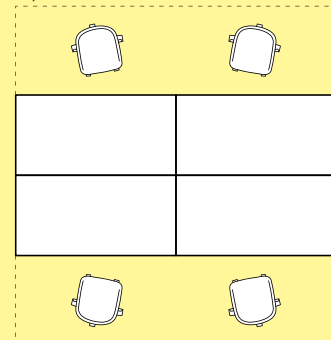

14,1 m²

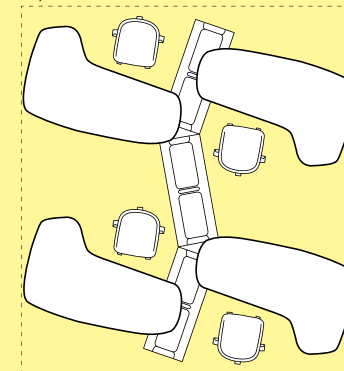

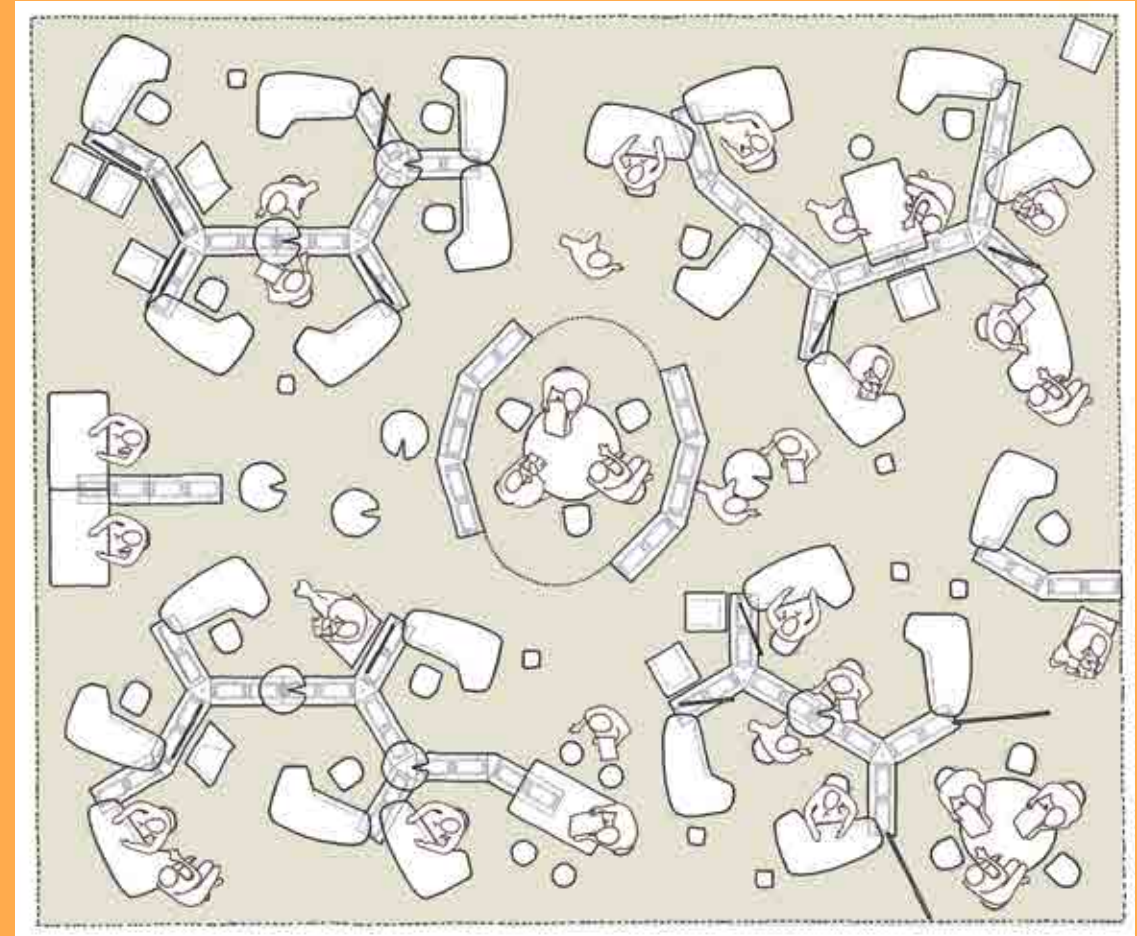
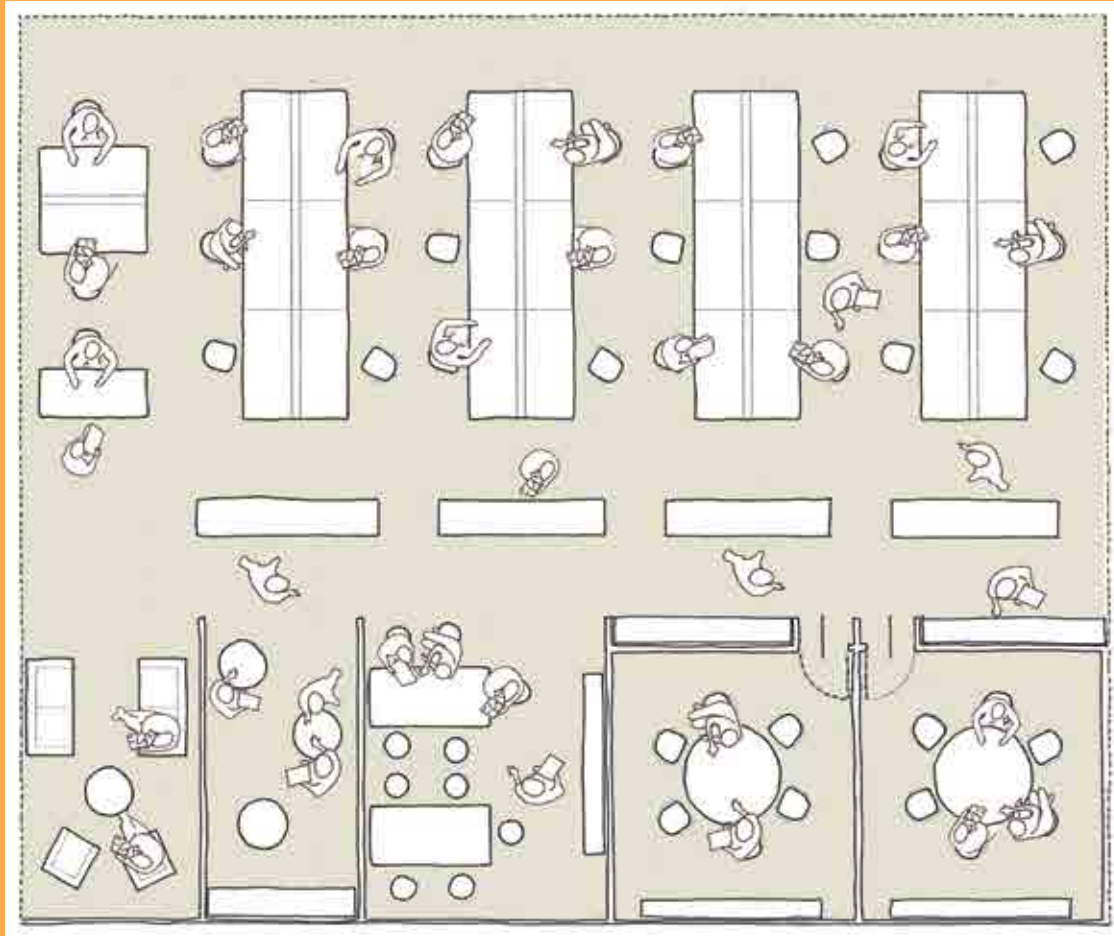

Beta manages space differently with respect to a traditional office system, offering a surprising variety of layouts which favour the exchange of ideas and information without compromising the need for privacy.

Beta gestisce lo spazio in modo diverso da un tradizionale sistema per ufficio, offrendo una gamma di layout dall'effetto inaspettato che favoriscono la condivisione delle idee e delle informazioni senza compromettere la privacy individuale.



Workstations are like platforms, which enable individual and collective activities and personal possessions holding too. In the semi-evolved and evolved versions in lacquer, the border of the desk top is rounded to ensure proper support to the forearm and improve comfort, while the melamine version has a geometrically formed border.

Le postazioni sono come piattaforme sulle quali le persone svolgono attività individuali e collettive, adatte anche per contenere gli oggetti personali. Nella versione semievoluta ed evoluta in laccato il bordo dei piani è smussato per assicurare l'appoggio corretto dell'avambraccio ed un maggior comfort, mentre nella versione melaminico il bordo è geometrico.





Being a container, display and support for accessories with integrated cable routing, the backbone allows Beta to grow without limits relative to the size of the space, acting as the infrastructure which handles technological connections, thus doing away with the need for cavity ceilings and computer floors. The base of the backbone, separated from the central body, has been designed to facilitate the tasks of tracing out the layout, verifying the division of space and laying out tech systems in advance, as well as simplifying the job of levelling the assembly. The innovative assembly/disassembly system simplifies installation and greatly reduces costs.

Elemento contenitore, espositore e supporto per gli accessori con cablaggio integrato, il backbone consente la crescita di Beta senza vincoli rispetto alle dimensioni dello spazio, agendo da infrastruttura che gestisce i collegamenti tecnologici evitando ulteriori dispositivi come controsoffitti e computer floor. La base del backbone separata dal corpo centrale è stata così progettata per facilitare l'opera di tracciatura del layout, verificare in anticipo la suddivisione degli spazi e la posa degli impianti, semplificare la messa in bolla. L'innovativo sistema di montaggio/smontaggio limita le complesse attività di cantiere, riducendo notevolmente i costi.













Nomos

Design:
Norman Foster
 1986



A design which changed our way of thinking about the object that is the table forever. Nomos is the pioneer of all shared structure systems and a recognised icon of industrial design. The basic concept is simple: a surface rests on a structure with a central backbone, 2 side support arms and 4 tilted, projecting legs, analogous to the structure of vertebra and ribs of the human body. Conceived as a solid skeleton with a zoomorphic aesthetic, it allows the dry construction of a wide range of compositions that can be adapted to multiple uses, from individual workstations to large meeting tables, to the latest desk-sharing solutions. Versatile and extremely resistant, Nomos today also boasts the intelligence of I.O.T.

Un progetto che ha cambiato per sempre il modo di pensare all'oggetto tavolo, Nomos è pioniere di tutti i sistemi a struttura condivisa e un'icona riconosciuta dell'industrial design. L'idea base è semplice: un piano si appoggia su una struttura con una spina centrale, 2 bracci laterali di sostegno e 4 gambe inclinate a stelo, in analogia con la struttura di spina dorsale e costole del corpo umano. Concepito quindi come un solido scheletro dall'estetica zoomorfica, permette di costruire a secco un'ampia gamma di composizioni adattabili a molteplici tipologie d'uso, dalle postazioni individuali ai grandi tavoli meeting, passando dalle più attuali soluzioni di lavoro in desk sharing. Versatile ed estremamente resistente, Nomos è oggi dotato di intelligenza I.O.T.

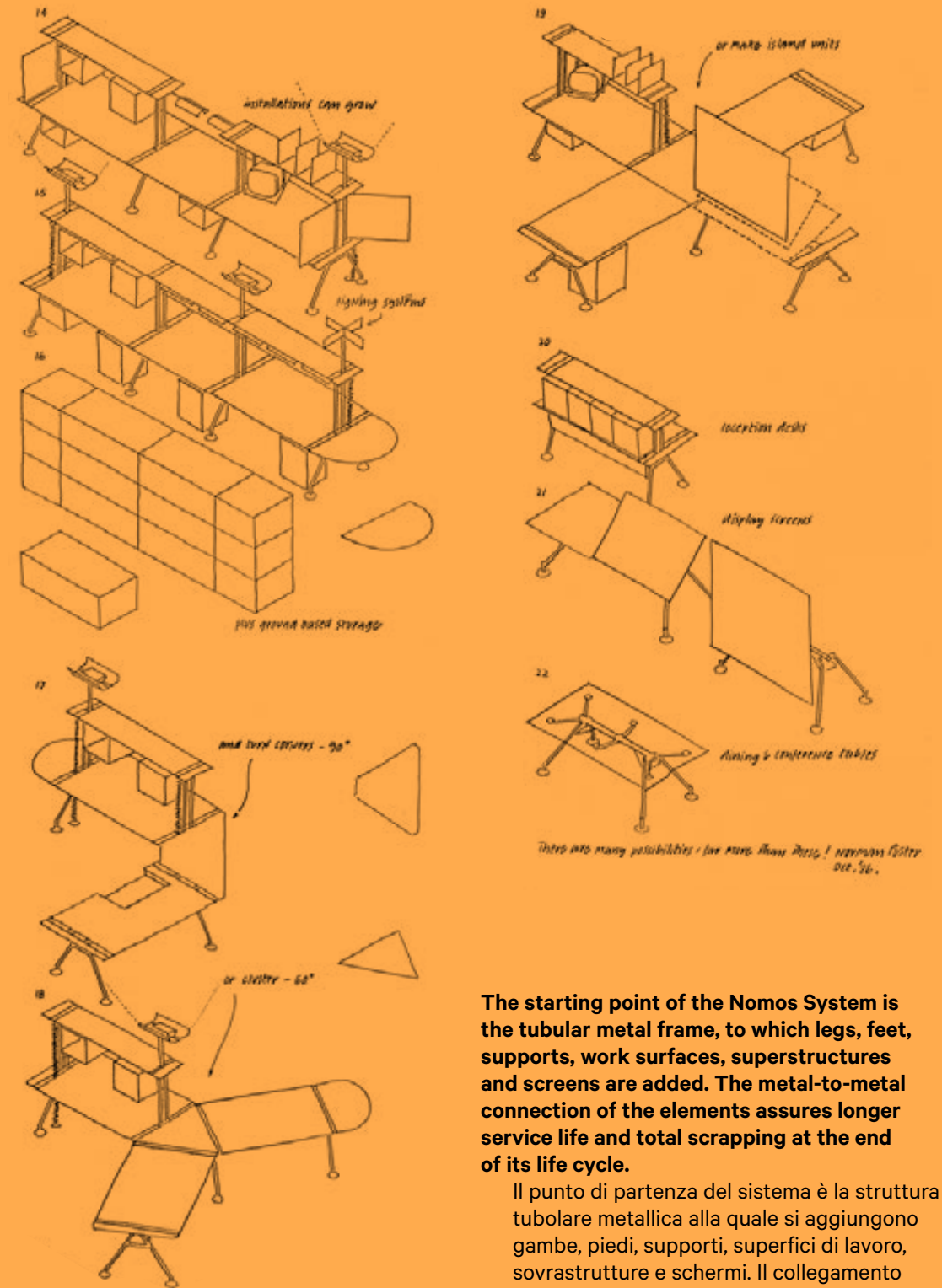
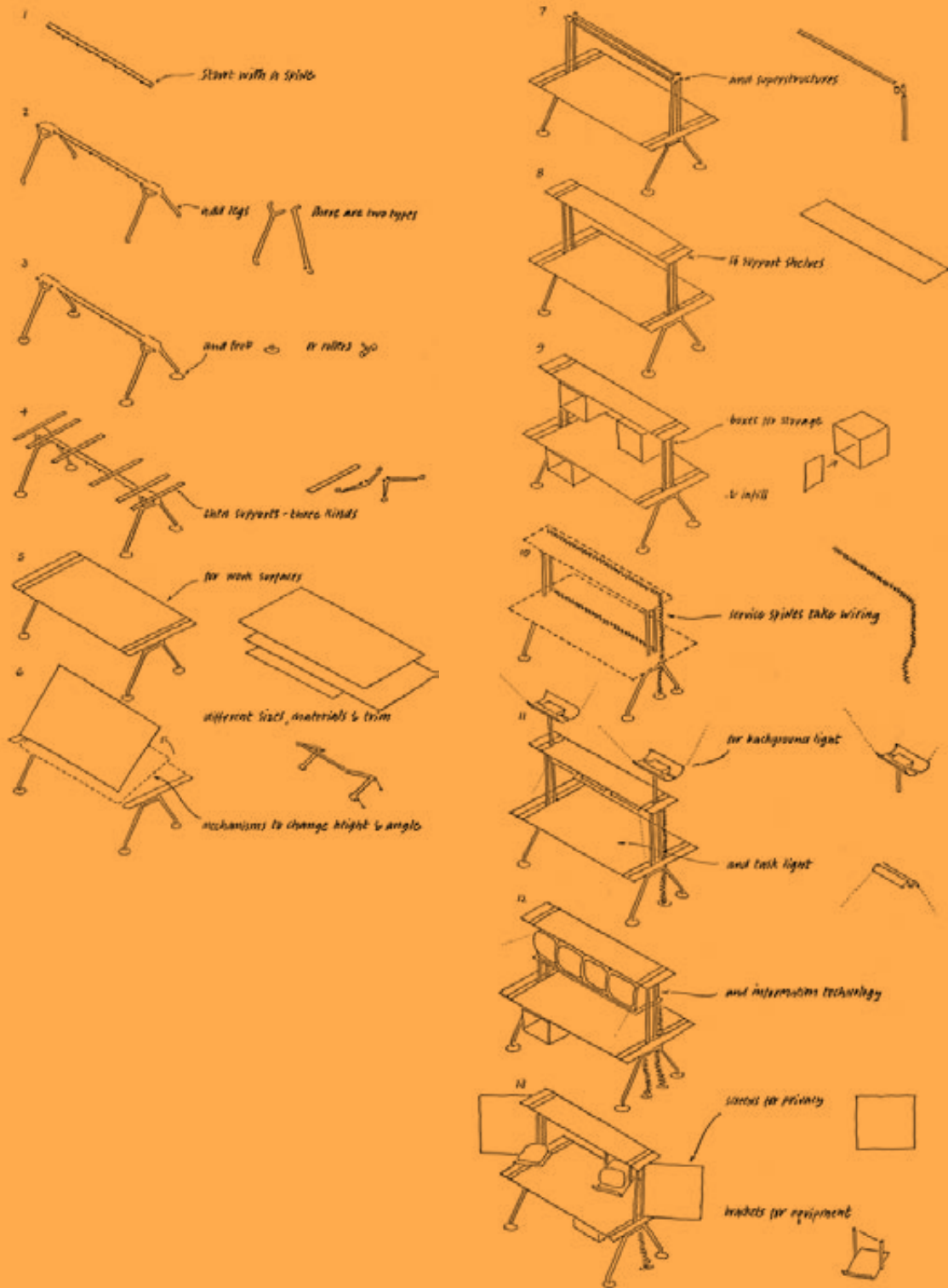

The starting point of the Nomos System is the tubular metal frame, to which legs, feet, supports, work surfaces, superstructures and screens are added. The metal-to-metal connection of the elements assures longer service life and total scrapping at the end of its life cycle.

Il punto di partenza del sistema è la struttura tubolare metallica alla quale si aggiungono gambe, piedi, supporti, superfici di lavoro, sovrastrutture e schermi. Il collegamento delle componenti "metallo con metallo" assicura una maggiore durata nel tempo e la totale dismissione al termine del ciclo di vita.

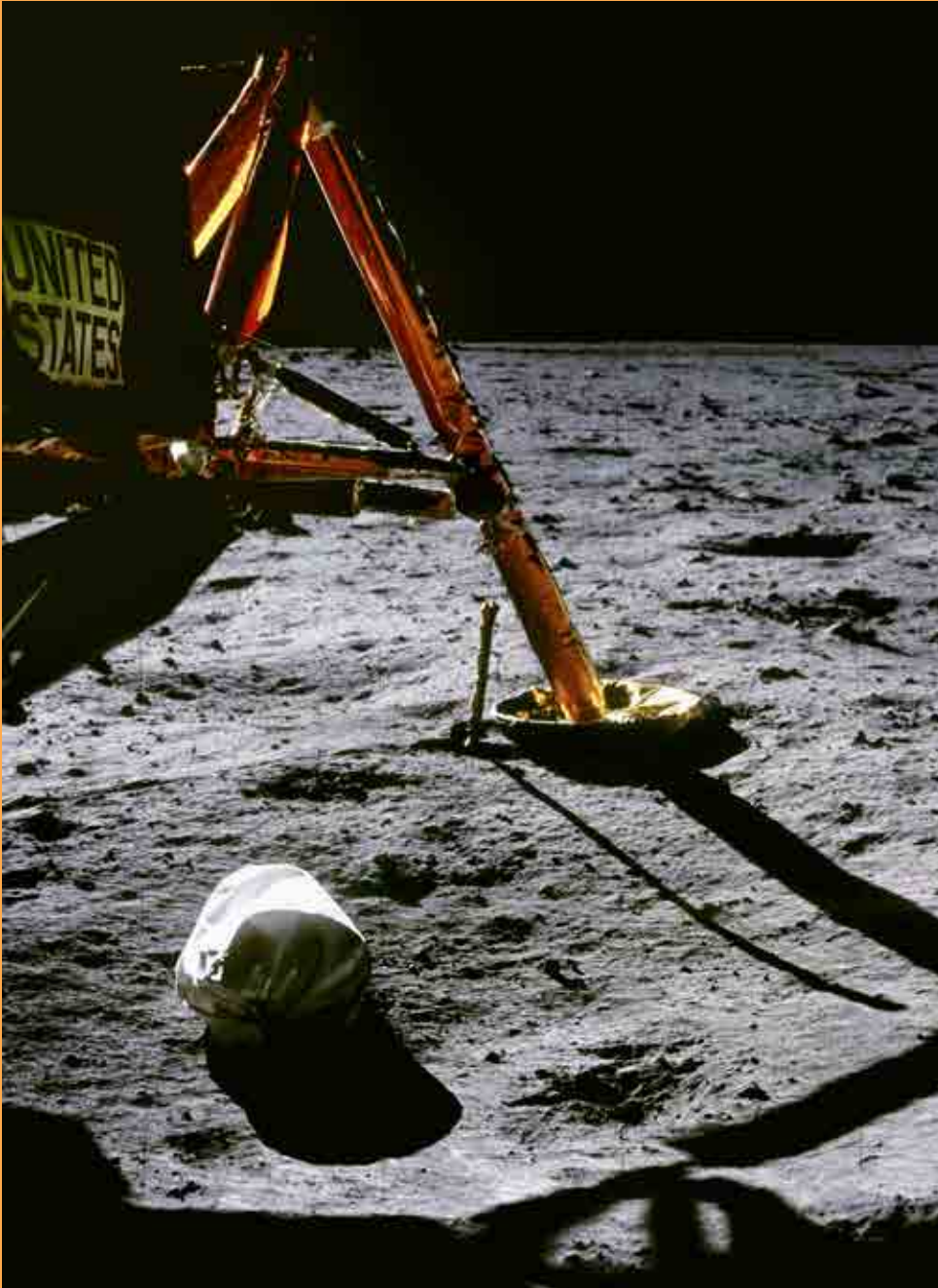

1969. Mankind lands on the Moon.
1969. L'Uomo approda sulla Luna.

1987. Nomos Table leg seen through the photographic lens of Mauro Masera.
1987. La gamba del tavolo Nomos vista attraverso l'obiettivo fotografico di Mauro Masera.





1987. Nomos patented wiring duct seen through the photographic lens of Mauro Masera.

1987. La vertebra salita cavi brevettata di Nomos vista attraverso l'obiettivo fotografico di Mauro Masera.

Human spine.

Colonna vertebrale umana.

Nomos System
BNL, Rome (Italy), 1991



Nomos System
Financial Business Company, Rome (Italy), 1993



Reina Sofia Museum, Madrid (Spain), 1995











The Nomos Table differs from the other components of the Nomos System for the size of its tubular frame (25 mm / 1" instead of 30 mm / 1 1/4"), for the angled shape of its base and for the dedicated castings that support the top instead of the basic substructures of the System.

Il Tavolo Nomos si distingue dal Sistema per la sezione del tubo (25 mm rispetto a 30 mm), per la sagoma inclinata delle basi e per le speciali fusioni di supporto dei piani che sostituiscono le sottostrutture del Sistema.

The spacers supplied with the Nomos Table allow to set 2 desk top heights (72 cm / 28 1/8" or 65 cm / 25 5/8"), reconfigurable as needed.

Il diverso montaggio del distanziale in dotazione permette di scegliere tra 2 altezze del Tavolo (72 cm o 65 cm), riconfigurabile a seconda delle esigenze.

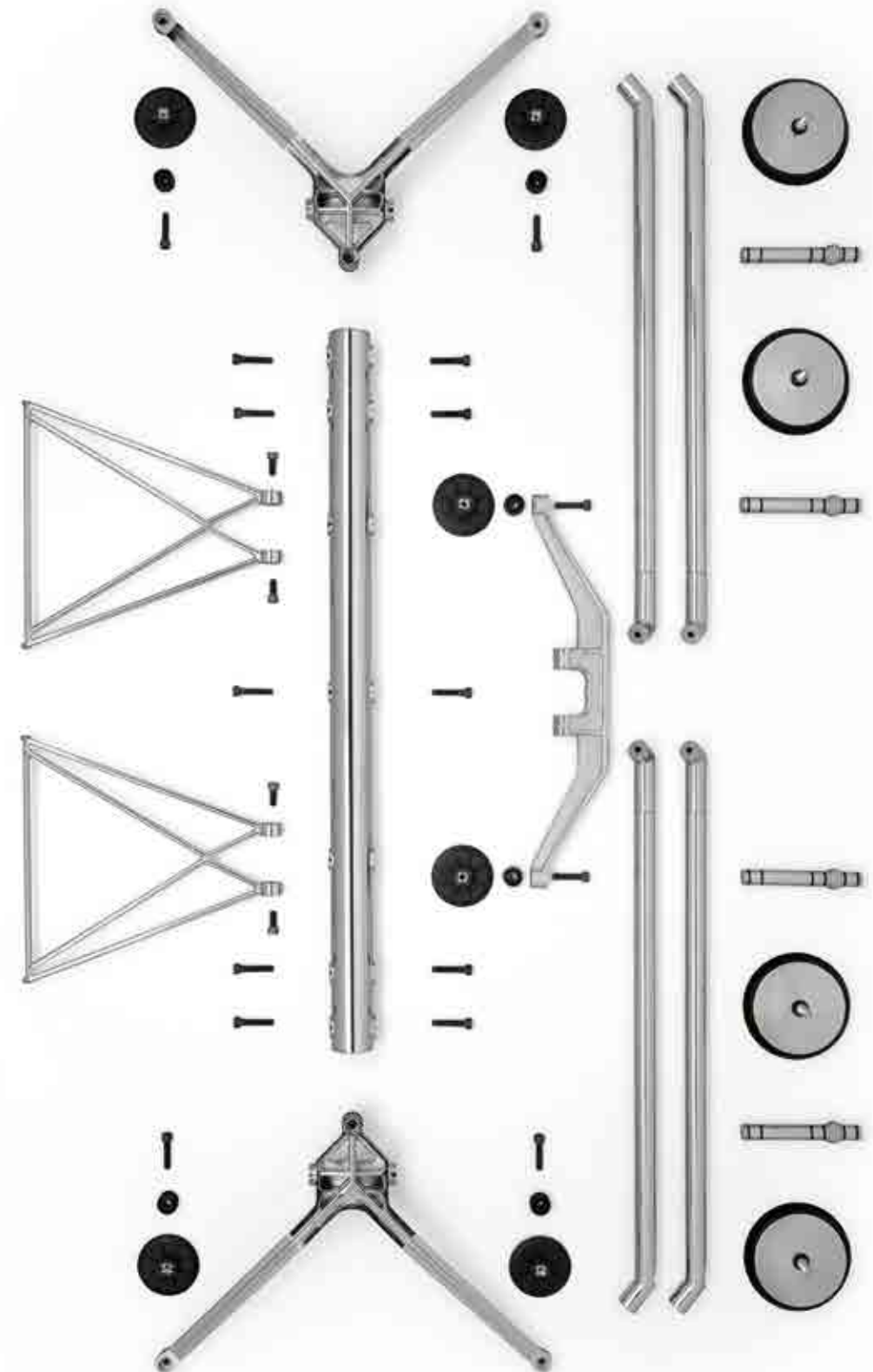



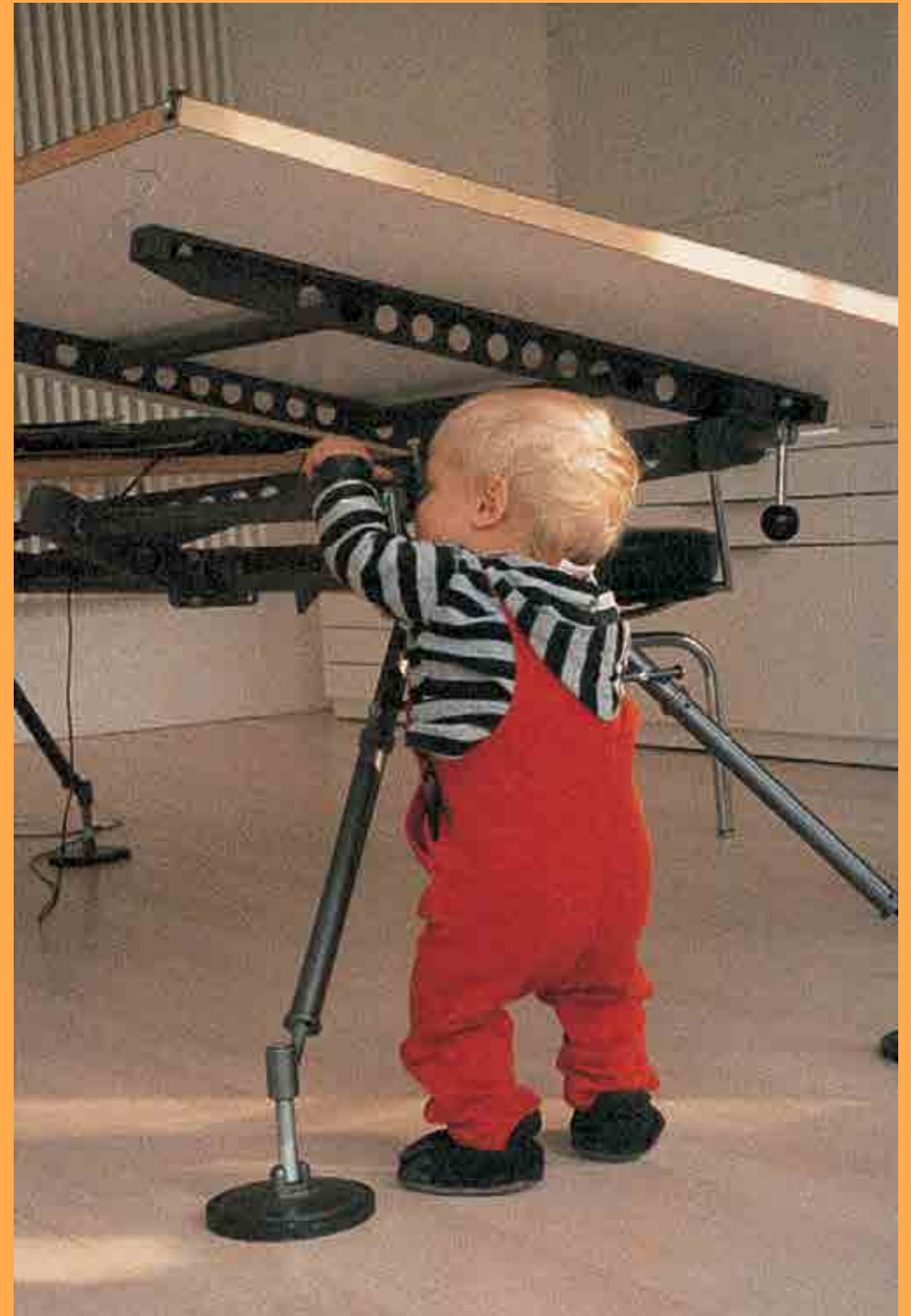

1986. A baby explores one of first Nomos drawing desk prototypes.

1986. Un bambino esplora uno dei primi prototipi di Nomos in versione tavolo da disegno.

Graphis

Design:
Eugenio Gerli, Osvaldo Borsani
 1968

A complete office furniture range, including individual workstations, long shared workstations, compositions with partition screens, stations with panels in arrays and a different meeting solutions. In the Seventies, Graphis did away with the conventional individual desk, introducing a new way of thinking about the workplace as a whole. Rationality and formal minimalism are the defining characteristics of an innovative project based on the use of a small number of highly versatile modular components: corner supports, panel bases, partition screens and rectangular or round desk tops.

Sistema completo d'arredo ufficio, declinabile in posto di lavoro individuale, lunghe workstation condivise, composizioni con screen divisori, postazioni con pannelli in batteria o numerose soluzioni meeting. Graphis ha rappresentato negli anni Sessanta il superamento del mobile singolo, introducendo un nuovo modo di ragionare sull'ambiente complessivo. Razionalità e pulizia formale definiscono infatti un progetto innovativo basato sulla logica di un numero ridotto di componenti molto versatili, che possono essere ripetuti e combinati: angolari di supporto, basi a pannello, screen divisori e piani rettangolari o rotondi.





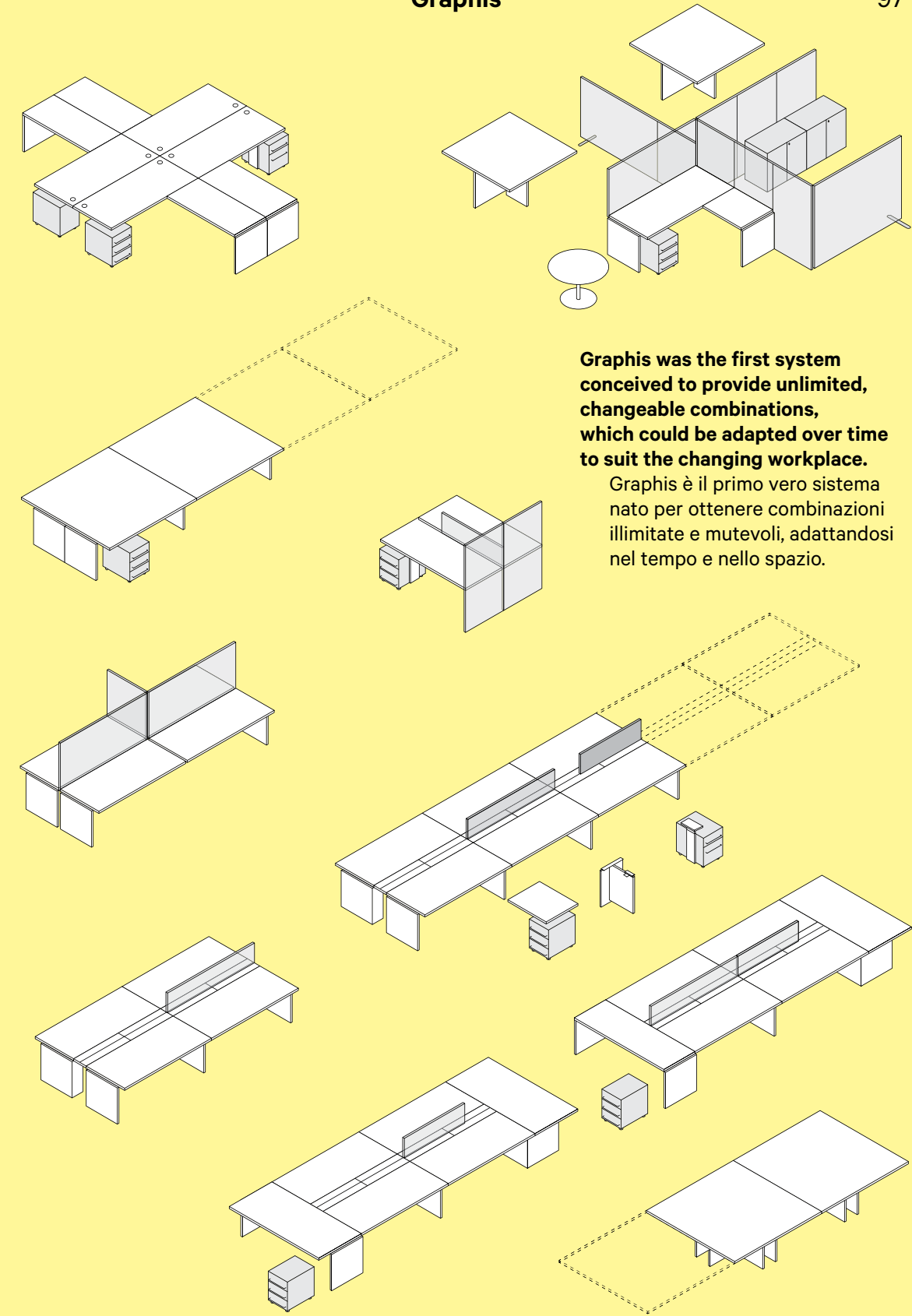
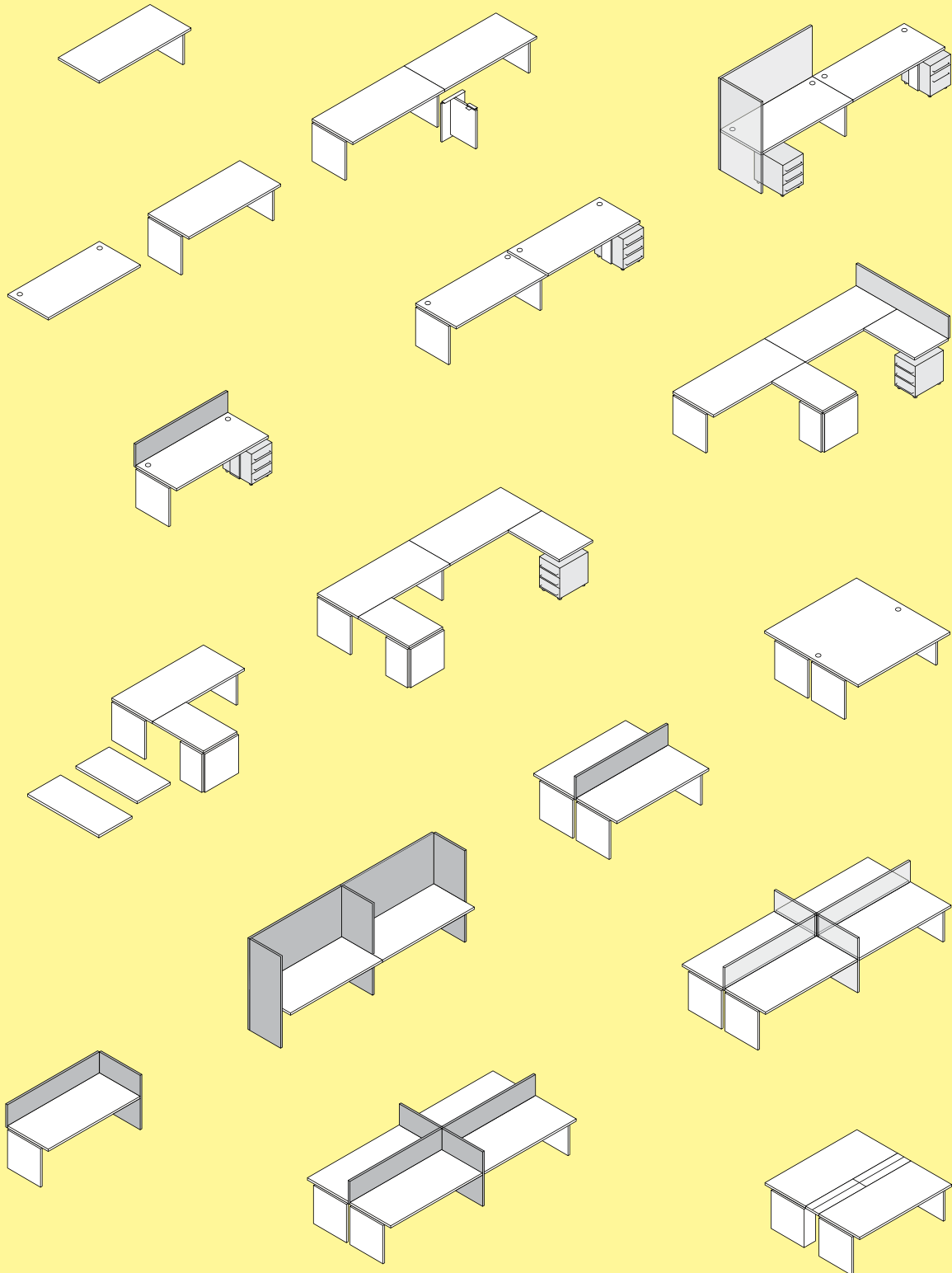

Graphis was the first system conceived to provide unlimited, changeable combinations, which could be adapted over time to suit the changing workplace.
 Graphis è il primo vero sistema nato per ottenere combinazioni illimitate e mutevoli, adattandosi nel tempo e nello spazio.





Its formal purity and unlimited configurations make Graphis the perfect solution even in home office settings.

La purezza formale e le infinite possibilità di configurazione rendono Graphis perfetta anche in situazioni home-office.





Bird's-eye view of the Graphis office system components.

Vista dall'alto delle componenti del sistema per uffici Graphis.



1974. Graphis outside a university classroom.

1974. Graphis all'esterno delle aule di un'università.

Multy

Design:
Gabriele e Oscar Buratti
 2014

This innovative partition system is conceived to divide and create spaces, allowing visual privacy and reducing disturbing noise, to satisfy above all the functional demands of open space and co-working environments. The system comprises a single element - a soundproof panel - which can be combined with others to create a variety of configurations. Compatible with the I.O.T technology, Multy has a perimeter structure and an internal vertical joint which allow to yield a variety of geometrical layouts, as well as equipping several accessories and enabling panels to be overlapped, while optional locking brackets can be used to fix the installation in place.

Innovativo sistema di partizione nato per dividere e strutturare spazi, creando privacy visiva e riducendo l'impatto acustico, per soddisfare in particolare le richieste funzionali di ambienti open space e situazioni co-working. Il sistema è composto da un unico elemento, un pannello fonoassorbente, che può essere configurato, aggregato e attrezzato per creare diversi scenari. Integrabile con la tecnologia I.O.T, Multy è provvisto di una struttura di aggancio perimetrale e di uno snodo verticale interno che consentono di definire diverse geometrie, aggiungere numerosi accessori o sovrapporre i pannelli, mentre staffette di bloccaggio opzionali permettono di fissare la posizione.



The desk panel allows the user to manage his workstation autonomously and flexibly.

Il pannello da scrivania consente di gestire in modo autonomo e flessibile la propria postazione lavoro.



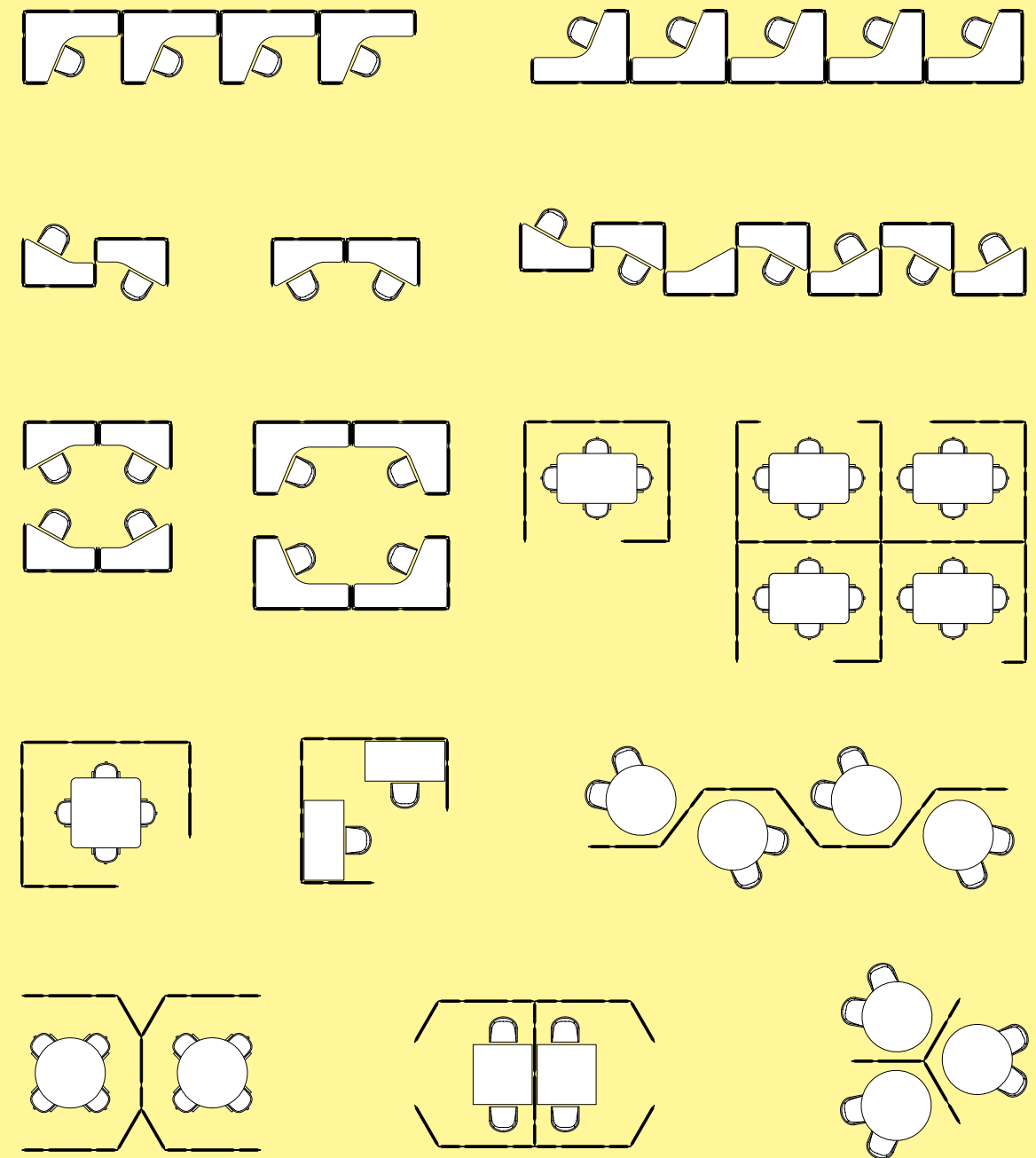
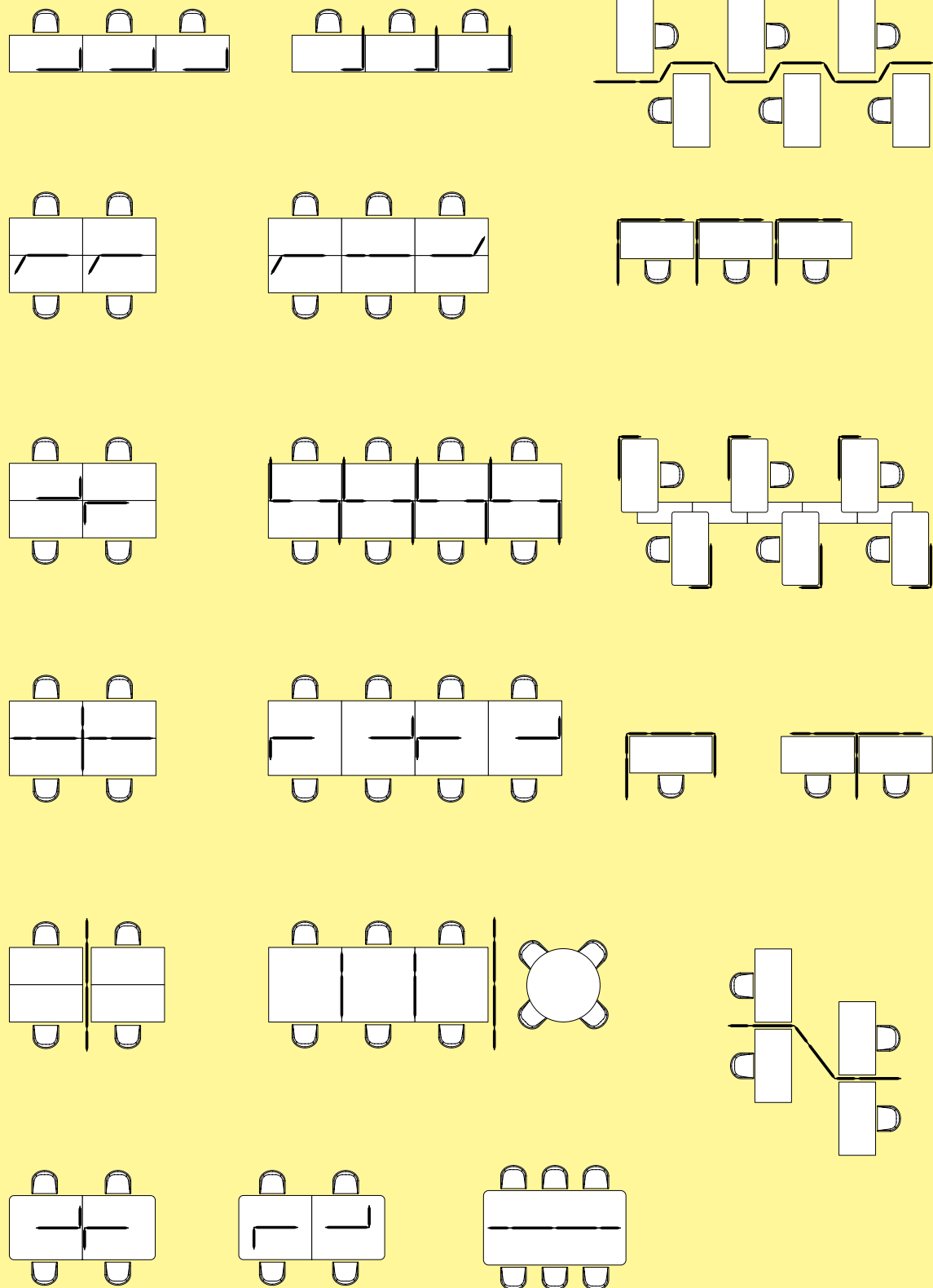

The modular assembly of the panels creates unlimited layouts which can be reconfigured as needed.

La ripetizione modulare dei pannelli sviluppa infinite possibilità di layout riconfigurabili nel tempo.

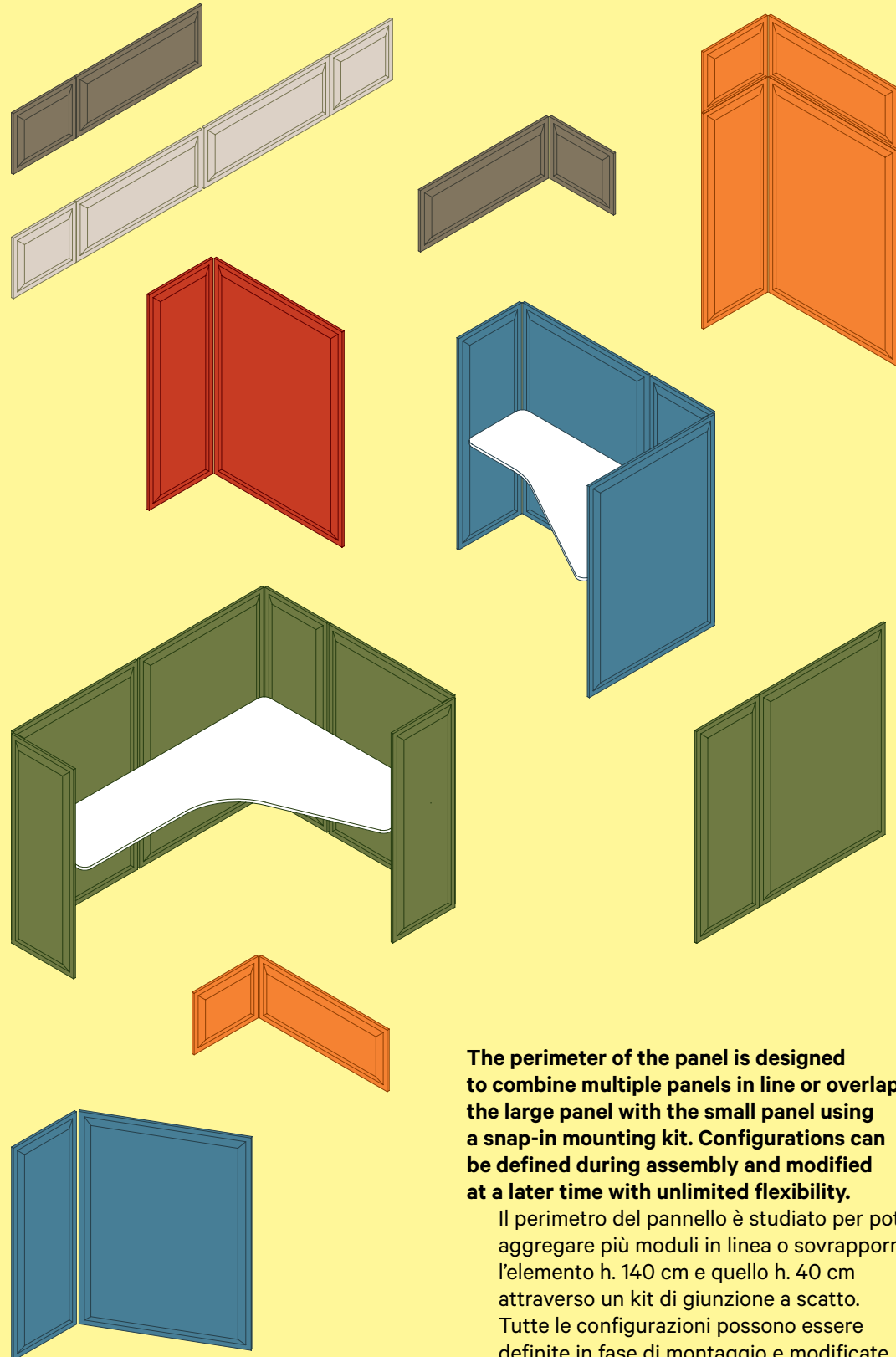

The perimeter of the panel is designed to combine multiple panels in line or overlap the large panel with the small panel using a snap-in mounting kit. Configurations can be defined during assembly and modified at a later time with unlimited flexibility.

Il perimetro del pannello è studiato per poter aggregare più moduli in linea o sovrapporre l'elemento h. 140 cm e quello h. 40 cm attraverso un kit di giunzione a scatto. Tutte le configurazioni possono essere definite in fase di montaggio e modificate nel tempo con la massima flessibilità.



The panel, which is composed of two external polyester fibre sheets press-formed at high temperature, is rated to acoustic absorption class A per UNI EN ISO 11654, and it achieves 20 dB noise abatement per UNI EN ISO 717.

Il pannello, composto da due gusci esterni in fibra di poliestere ottenuti con la tecnologia della pressoformatura ad alta temperatura, raggiunge la classe di assorbimento acustico A secondo la norma UNI EN ISO 11654, oltre che un abbattimento acustico di 20 dB secondo la norma UNI EN ISO 717.

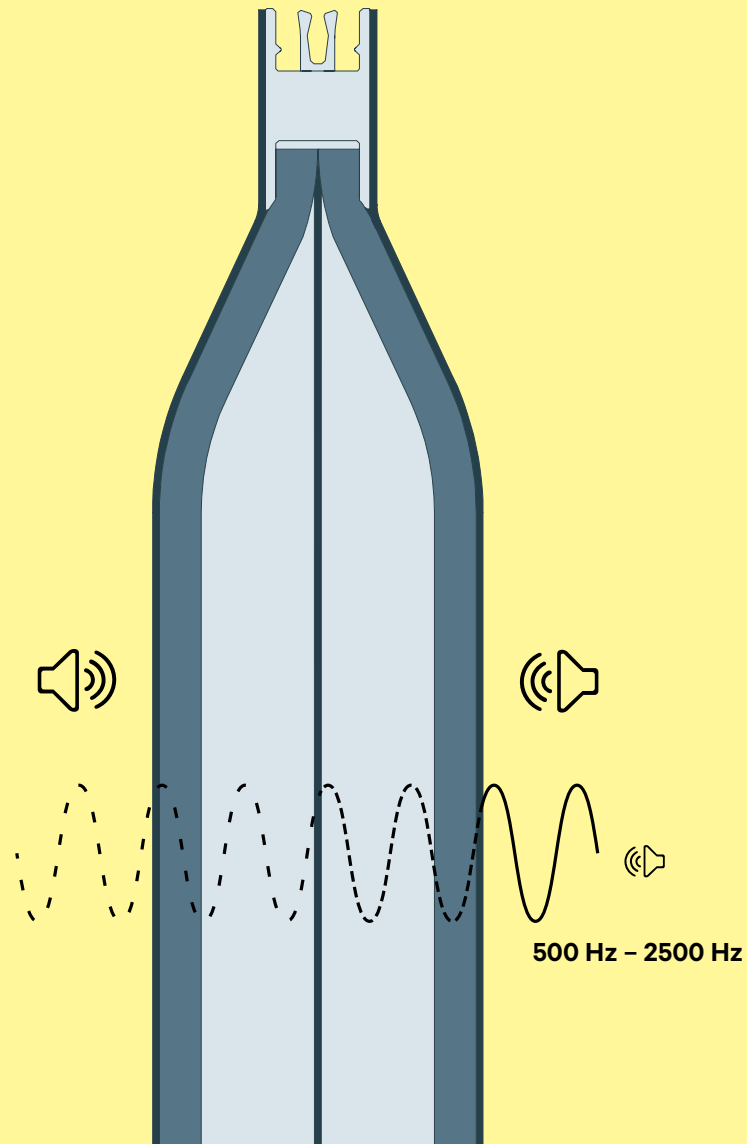

Design:
Centro Progetti Tecno
2005

The practical, robust family of containers, useful in any work setting. The 2 and 3 drawer units, the supports and the containers with drawers in a variety of sizes can be combined horizontally, vertically, freestanding at the centre of the room or back-to-back, enabling free organisation of storage areas, dividing the space and also acting as temporary work surfaces.

Famiglia di contenitori pratici e resistenti, utili in tutti i contesti work. Le cassettiere (a 2 o 3 cassetti), i supporti e i contenitori con ante nelle diverse dimensioni possono essere disposti orizzontalmente, verticalmente, freestanding a centro stanza o back to back, organizzando liberamente le aree storage, suddividendo gli spazi e trasformandosi in piani di appoggio temporanei.



The simplicity of its design and attention to geometrical details make this an extremely discreet and versatile collection.

L'essenzialità del disegno e l'attenzione progettuale ai dettagli geometrici identificano una collezione estremamente discreta e versatile.





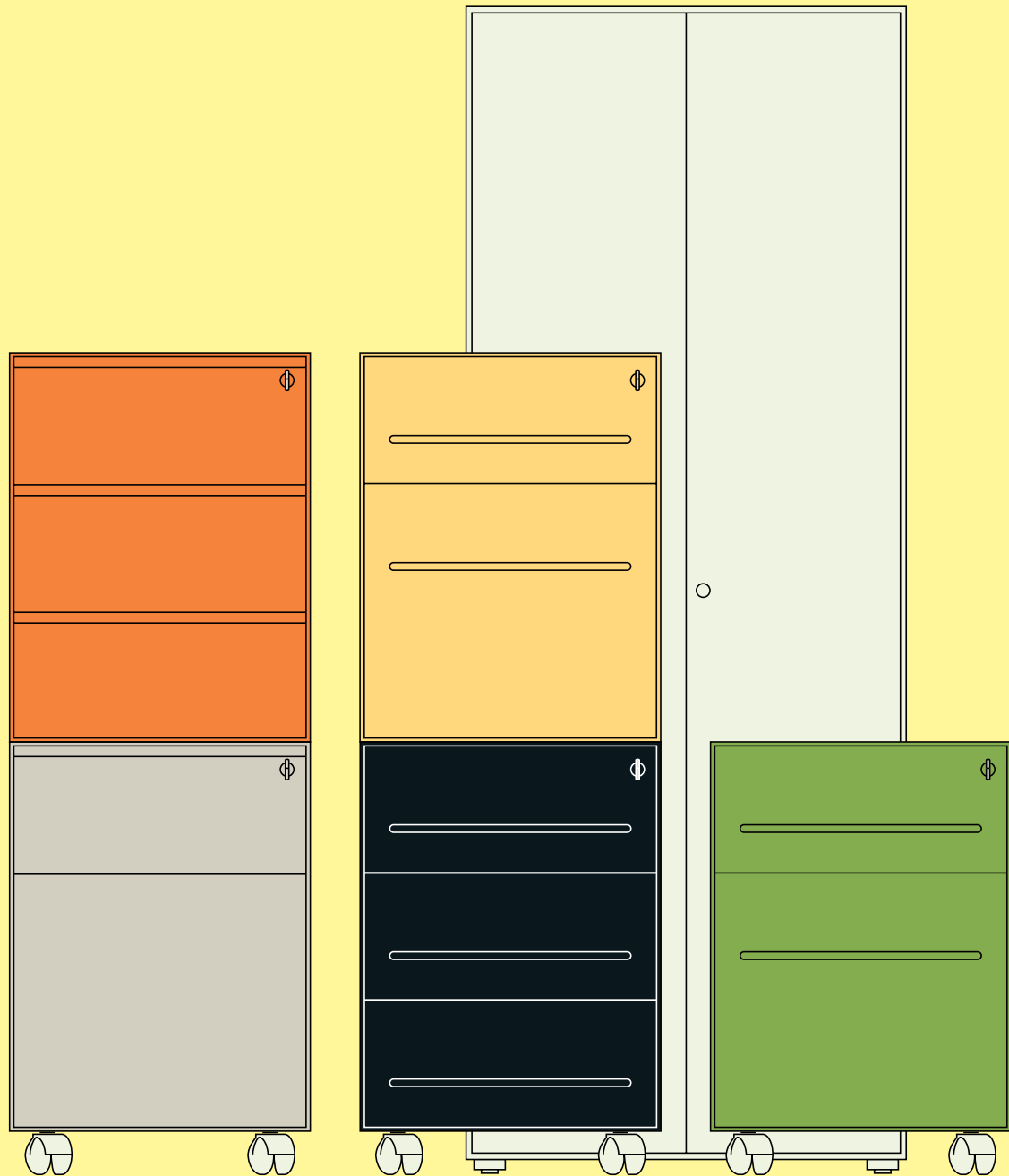

The fully-metal containers create visual continuity between rooms and offer functional work surfaces, whether installed next to workstations or in shared areas.

I contenitori, realizzati completamente in metallo, creano continuità visiva tra i diversi ambienti e offrono un appoggio funzionale efficace sia accostati a postazioni individuali sia inseriti in aree condivise.





Design:
Zanon Architetti Associati, Centro Progetti Tecno
 2018

A modular, continually reconfigurable micro-architectural system, designed to define and organise spaces. The result is a flexible structure that can be customised to suit the layout of spaces and specific needs: a simple and functional solution that can characterise interior design projects, from work environment to educational spaces. Available in a wide range of materials and finishes, the structures can be integrated with accessories including cupboards, drawers, shelves, blackboards and seats, and can be equipped with I.O.T technology.

Sistema micro-architettonico, modulare e continuamente riconfigurabile, studiato per definire e organizzare gli spazi. Il risultato è una struttura flessibile e personalizzabile in relazione alla disposizione degli ambienti e alle necessità di utilizzo: una soluzione semplice e funzionale che può caratterizzare molteplici progetti di interior, dai luoghi di lavoro fino ad ambienti educational. In una grande varietà di materiali e finiture, le strutture si integrano con accessori come ante, cassetti, ripiani, lavagne e sedute e possono accogliere la tecnologia I.O.T.





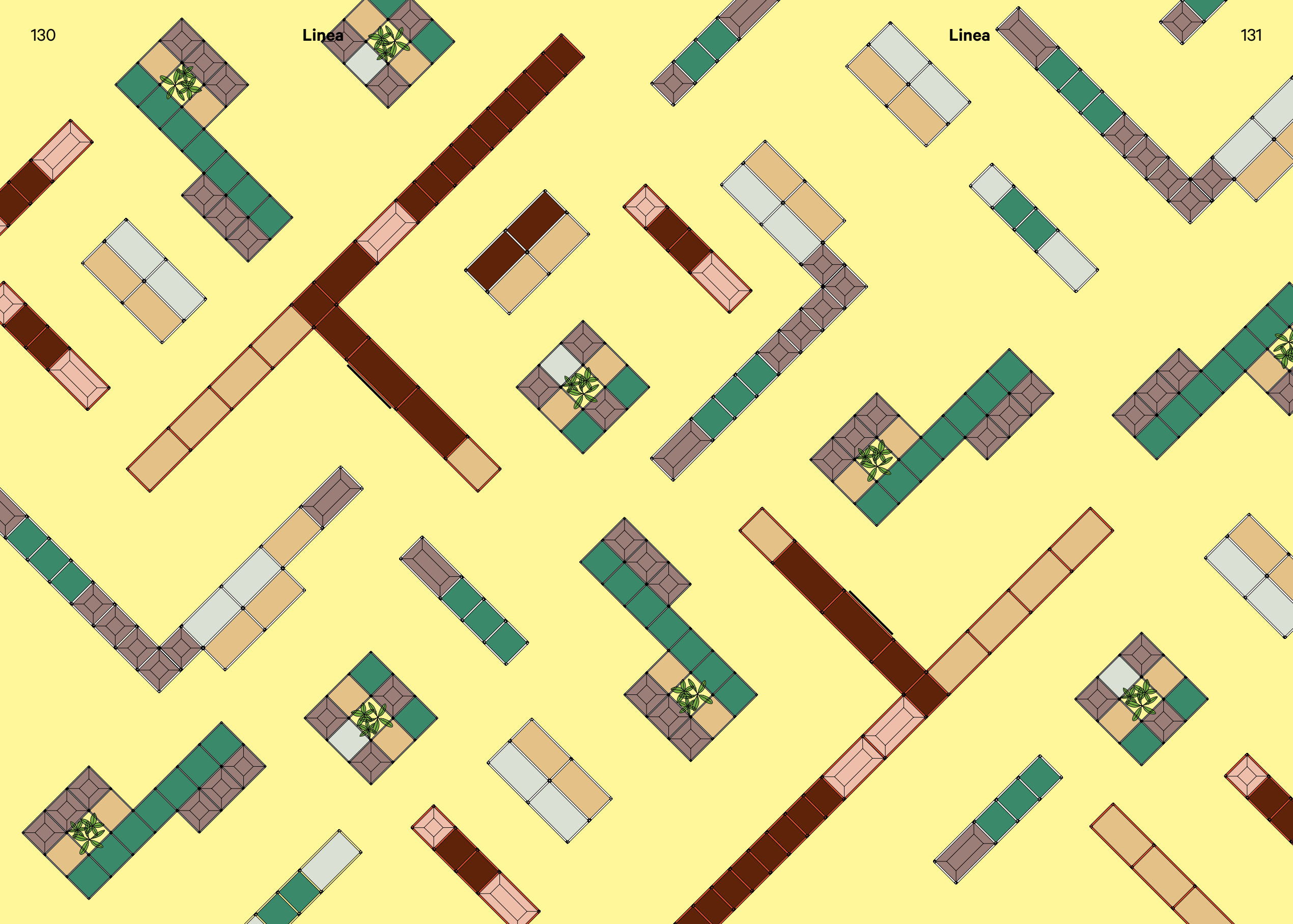

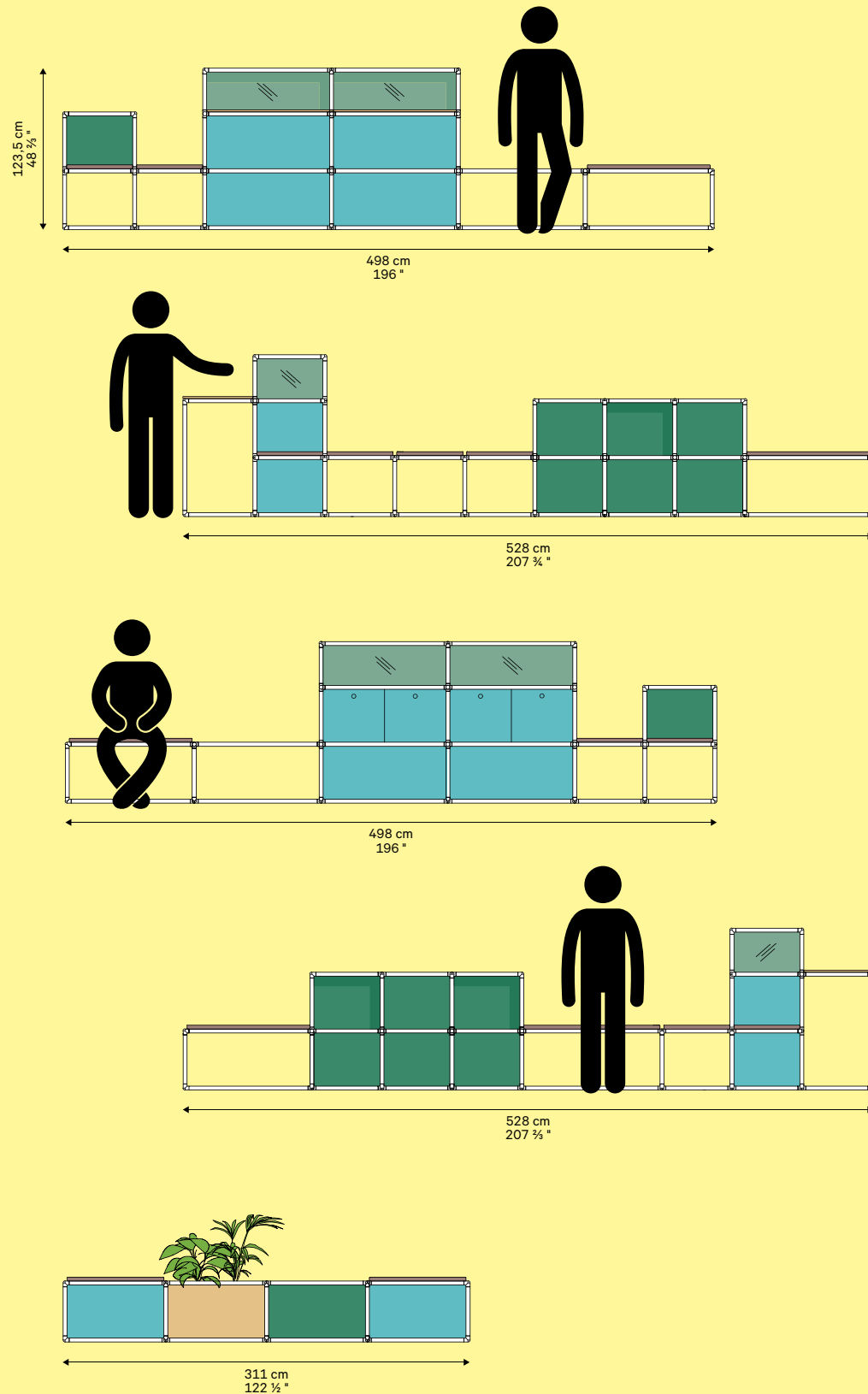

The construction elements (ball joint, tubular sections, panels) and minimalist, almost archetypal shapes, combine to serve various functions, creating horizontal surfaces such as worktops and seats, vertical surfaces to divide up space, shapes that become containers and supports that can be integrated with lighting systems, fabrics and acoustic panels.

Gli elementi costruttivi (snodo, tubolari, pannelli), forme minime quasi archetipiche, si combinano per rispondere a diverse funzioni, creando superfici orizzontali come piani d'appoggio e sedute, piani verticali per ripartire lo spazio, forme che diventano contenitori o supporti integrabili con sistemi d'illuminazione, tessuti e pannelli acustici.





Office spaces host our daily work while also representing the values of the brand. Head offices provide space for personal studies and rooms designed for discussions, conference calls and meetings: with their strong identity, the executive collections are efficient and stand out for their high quality.

Le aree dedicate agli uffici ospitano il lavoro quotidiano e al tempo stesso rappresentano i valori del brand. Gli ambienti direzionali accolgono studi personali e sale meeting pensate per riunioni collettive, conference call o incontri più ristretti: fortemente identitarie, le proposte executive sono efficienti e contraddistinte da elevati standard qualitativi.

Executive Direzionali

Cento 150

Asymmetrical 156

Vara 168

lanus 174

Shift 192

T334 T335 198

Détabilisation 206

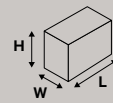

Cento pag. 150

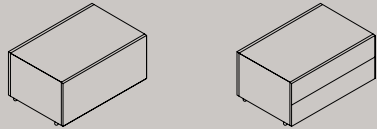

Single compartment storage with 1 or 2 drawers and lock, fixed base or castors

Contenitore a un vano con 1 o 2 cassetti e serratura, base fissa o su ruote
L 100 cm, W 65 cm, H 54,5 cm
L 39 1/2", W 25 3/8", H 21 1/2"

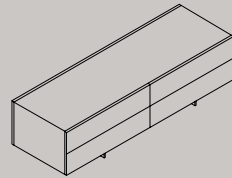

2-compartment storage with 1 or 2 drawers and lock, fixed base or castors

Contenitore a 2 vani con 1 o 2 cassetti e serratura, base fissa o su ruote
L 200 cm, W 65 cm, H 54,5 cm
L 78 3/4", W 25 3/8", H 21 1/2"

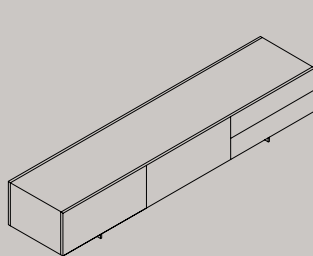

3-compartment storage with 1 or 2 drawers and lock, fixed base or castors

Contenitore a 3 vani con 1 o 2 cassetti e serratura, base fissa o su ruote
L 200 / 298,5 cm, W 65 cm, H 54,5 cm
L 78 3/4" / 117 1/2", W 25 3/8", H 21 1/2"

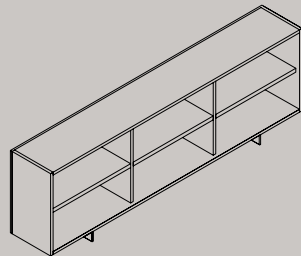

Open cabinet with optional décor back panel

Contenitore a giorno con controschienale opzionale
L 200 / 298,5 cm, W 48 cm, H 95 / 135,5 cm
L 78 3/4" / 117 1/2", W 19", H 37 1/2" / 53 1/2"

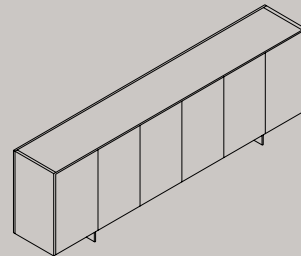

Cabinet with doors and lock with optional décor back panel

Contenitore ad ante con serratura e controschienale opzionale
L 200 / 298,5 cm, W 50 cm, H 95 / 135,5 cm
L 78 3/4" / 117 1/2", W 19 3/8", H 37 1/2" / 53 1/2"

Asymmetrical pag. 156

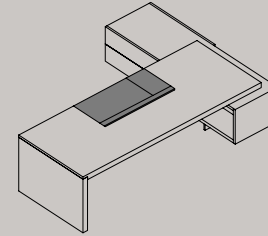

Desk with left or right storage unit and leather blotter

Scrivania con contenitore destro o sinistro e sottomano in pelle
L×W 242×135 / 272×200 / 307×200 cm, H 75 cm
L×W 95 1/2×53 1/4" / 107×78 3/4" / 121×78 3/4", H 29 1/2"

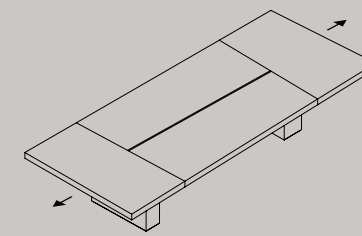

Rectangular meeting table with cable management

Tavolo riunione rettangolare predisposto per elettrificazione
L×W 380×160 / 450×180 / 550×200 cm, H 67 / 75 cm
L×W 149 3/8×63 / 177 1/4×71 / 216 1/2×78 3/4", H 26 1/2" / 29 1/2"

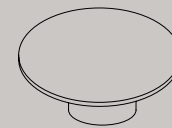

Meeting table with single top

Tavolo riunione con piano unico
Ø 160 / 180 cm, H 75 cm
Ø 63 / 71", H 29 1/2"

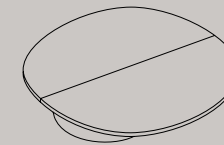

Oval meeting table

Tavolo riunione ovale
Ø 230 cm, H 67 / 75 cm
Ø 90 1/2", H 26 1/2" / 29 1/2"

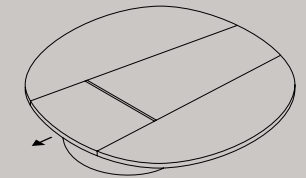

Oval meeting table with cable management

Tavolo riunione ovale predisposto per elettrificazione
Ø 300 cm, H 67 / 75 cm
Ø 118 1/2", H 26 1/2" / 29 1/2"



High Solenoide coffee table

Tavolino Solenoide alto
Ø 42 cm, H 58 cm
Ø 16 1/2", H 23"

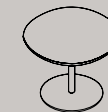

Low Solenoide coffee table

Tavolino Solenoide basso
L 60×42 cm, H 48 cm
L 23 3/8×16 1/2", H 19"



The drawings below show the maximum number leather blotter per meeting table and their position. I disegni in pianta indicano la posizione e il numero massimo di sottomani in base alla dimensione del tavolo.
L 70 cm, W 50 cm, H 7 cm
L 27 1/2", W 19 3/8", H 2 3/4"

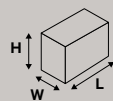

Vara pag. 168

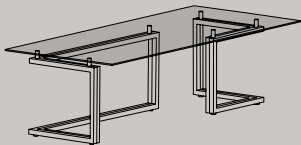

Desk
Scrivania
L×W 250×100 cm, H 75 cm
L×W 98 ½×39 ½", H 29 ½"

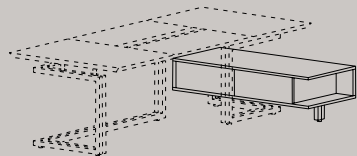

Left or right side storage unit
Contentore laterale per scrivania
L 60,6 cm, W 136 cm, H 25 cm
L 24", W 53 ½", H 9 ¾"

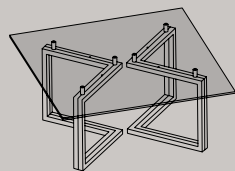

Square meeting table
Tavolo meeting quadrato
L×W 140×140 cm, H 73 cm
L×W 55×55", H 28 ¾"

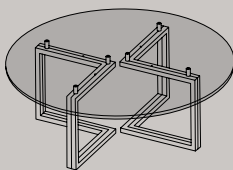

Round meeting table
Tavolo meeting rotondo
Ø 160 cm, H 73 cm
Ø 63", H 28 ¾"

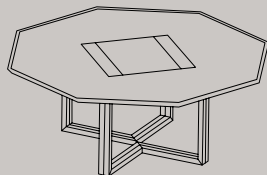

Octagonal meeting table
Tavolo meeting ottagonale
L×W 200×200 cm, H 73 cm
L×W 78 ¾×78 ¾", H 28 ¾"

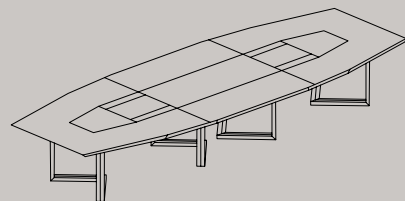

Conference table
Tavolo conference
L×W 500×180 cm, H 75 cm
L×W 197×71", H 29 ½"

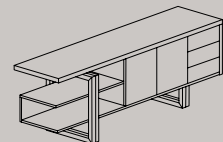

Small storage unit
Contentore basso
L 218 cm, W 54 cm, H 73 cm
L 86", W 21 ¼", H 28 ¾"

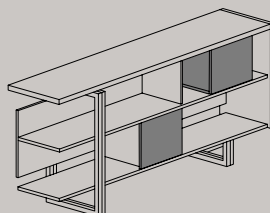

Large storage unit
Contentore alto
L 250 cm, W 55 cm, H 107 cm
L 98 ½", W 21 ¼", H 42 ¼"

Ianus pag. 174

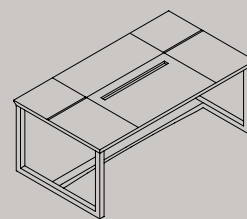

Desk with single top or with storage leather blotter
Scrivania con piano unico o con sottomano porta oggetti
L×W 180×100 / 210×100 cm, H 72 cm
L×W 71×39 ½ / 82 ¾×39 ½", H 28 ½"

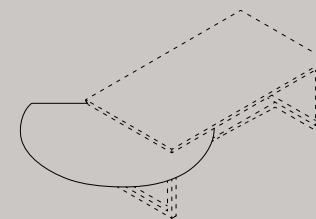

Semi-circular service top
Piano di servizio semi-circolare
L×W 137×157 cm
L×W 54×62"

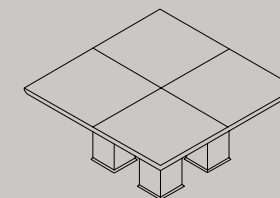

Square meeting table
Tavolo riunione quadrato
L×W 160×160 cm, H 72 cm
L×W 63×63", H 28 ½"

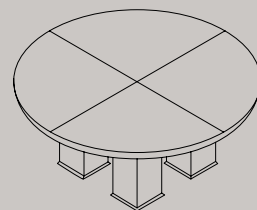

Round meeting table
Tavolo riunione rotondo
Ø 180 cm, H 72 cm
Ø 71", H 28 ½"

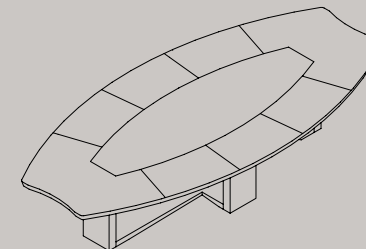

Elliptical meeting table
Tavolo riunione ellittico
L×W 280×145 / 350×165 / 420×180 cm, H 72 cm
L×W 110 ¼×57 / 137 ¾×65 / 165 ½×71", H 28 ½"

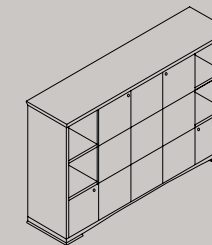

Storage unit
Contentore
L 100 cm, W 53,5 cm, H 57 cm
L 203 cm, W 50 cm, H 91 / 131 cm
L 283 cm, W 50 cm, H 91 / 131 cm
L 39 ½", W 21", H 22 ½"
L 80", W 19 ¾", H 36 / 51 ½"
L 111 ½", W 19 ¾", H 36 / 51 ½"

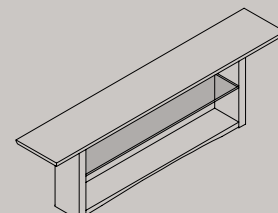

Console
Consolle
L 240 cm, W 50 cm, H 85 cm
L 94 ½", W 19 ¾", H 33 ½"

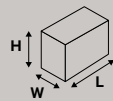

Shift pag. 192

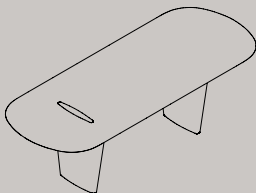

Desk
Scrivania
L×W 240×95 cm, H 75 cm
L×W 94 ½×37 ½", H 29 ½"

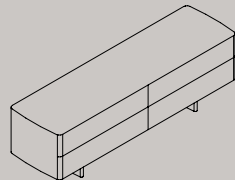

Storage unit with deep drawer or double drawers and lock
Contenitore con cassettone o doppi cassetti e serratura
L 190 cm, W 53 cm, H 59 cm
L 74 ¾", W 20 ¾", H 23 ½"

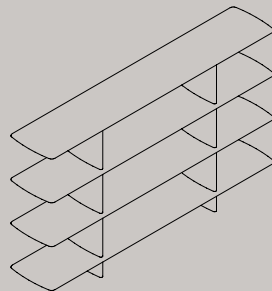

Bookcase
Libreria
L 240 cm, W 45 cm, H 99 / 139 cm
L 94 ½", W 17 ¾", H 39 / 54 ¾"

T334 T335 pag. 198

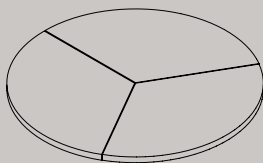

Coffee table
Tavolino
Ø 120 / 140 / 200, H 21 cm
Ø 47 ¼ / 55 ½ / 78 ¾", H 8 ¼"

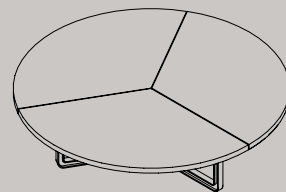

Round table
Tavolo tondo
Ø 160 / 250 / 300 cm, H 64 / 71 cm
Ø 63 / 98 ½ / 118", H 25 / 28"

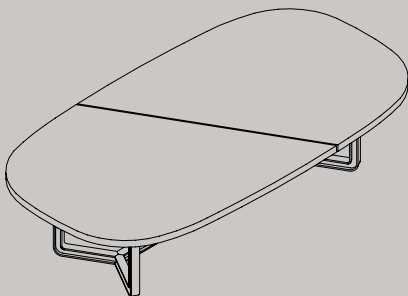

Meeting table
Tavolo meeting
L×W 300×160 / 450×180 / 550×190 cm, H 64 / 71 cm
L×W 118×63 / 177×71 / 216 ½×74 ¾", H 25 / 28"

Détabilisation pag. 206

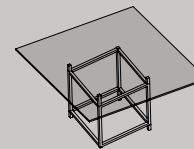

Square table
Tavolo quadrato
L×W 130×130 cm, H 72 cm
L×W 51 ¼×51 ¼", H 28 ½"

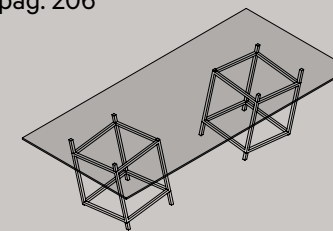

Rectangular table
Tavolo rettangolare
L×W 280×120 cm, H 72 cm
L×W 110 ¾×47 ¼", H 28 ½"

Cento 150
Asymmetrical 156
Vara 168
lanus 174
Shift 192
T334 T335 198
Détabilisation 206

Cento

Design:
Piero Lissoni
2005

A modular programme of storage units which are easy and practical to combine, yielding unlimited solutions – close to a wall or stand alone as an island – for filing, storage and dividing spaces. Their archetypal geometrical lines, fine lacquer finish on both internal and external surfaces, and apparently suspended shapes make this a timeless, highly refined collection.

Programma modulare di elementi storage che si compongono con estrema praticità e funzionalità, dando forma a molteplici soluzioni – a parete o centro stanza – adatte a diverse esigenze di archiviazione, contenimento, suddivisione.

Le linee geometriche archetipiche, la fine laccatura sia esterna che interna, le forme apparentemente sospese rendono la collezione raffinata e senza tempo.



The containers are available in 3 heights which can be matched and combined, while the units are available in swing doors, drawers, deep drawers or simply as open units.

I contenitori sono previsti in 3 altezze modulabili e combinabili mentre gli elementi sono disponibili con ante a battente, cassetti, cassettoni o semplicemente a giorno.





Asymmetrical

Design:
Piero Lissoni
2006

Desks and meeting tables defined by formal rigour, inspired by modern art. Asymmetrical tops, equipped with hidden cable management and service compartments, are suspended cantilevered on bases consisting of solid geometric supports, to deliver extra-large workstations. Asymmetrical is based on an idea of technical performance and functionality concealed in pure, minimal forms, held in a precise equilibrium.

Scrivanie e tavoli riunione definiti da rigore formale, ispirato alla pittura moderna.

I piani dalla sagoma asimmetrica, dotati di cablaggi e vani di servizio completamente nascosti, sono sospesi a sbalzo sulle basi costituite da solidi supporti geometrici, a comporre ampie postazioni di lavoro. Asymmetrical è basato su un'idea di tecnica e funzionalità celata in forme pure, minimali, tenute in un equilibrio preciso e rarefatto.

Asymmetrical
Axa, Madrid (Spain), 2008



Work top and container, both available in wood or laquer, can be matched freely to create the desk with the desired finish.

Le scrivanie prevedono piano e contenitore in essenza o laccato e le finiture sono liberamente accostabili tra loro.





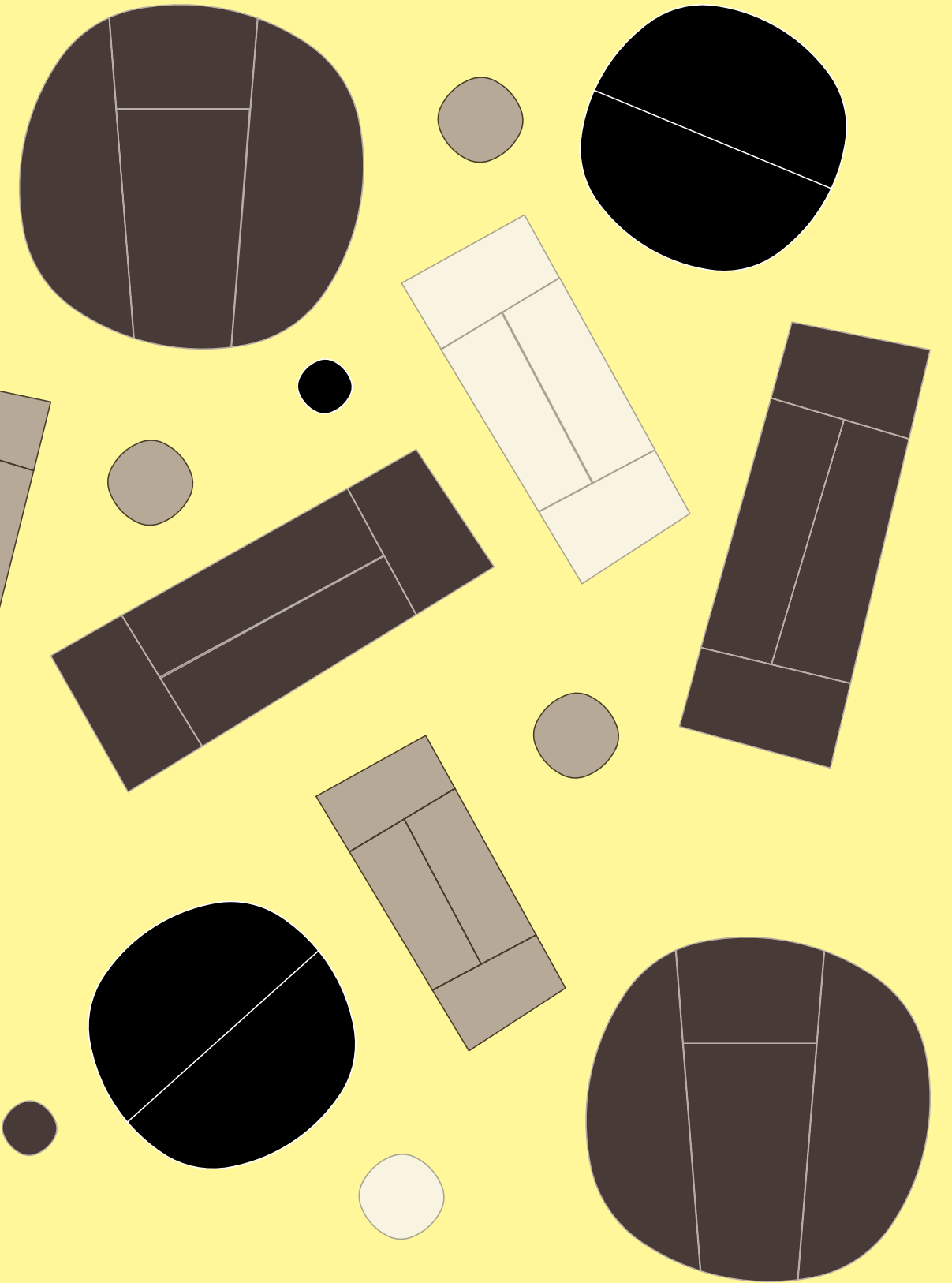
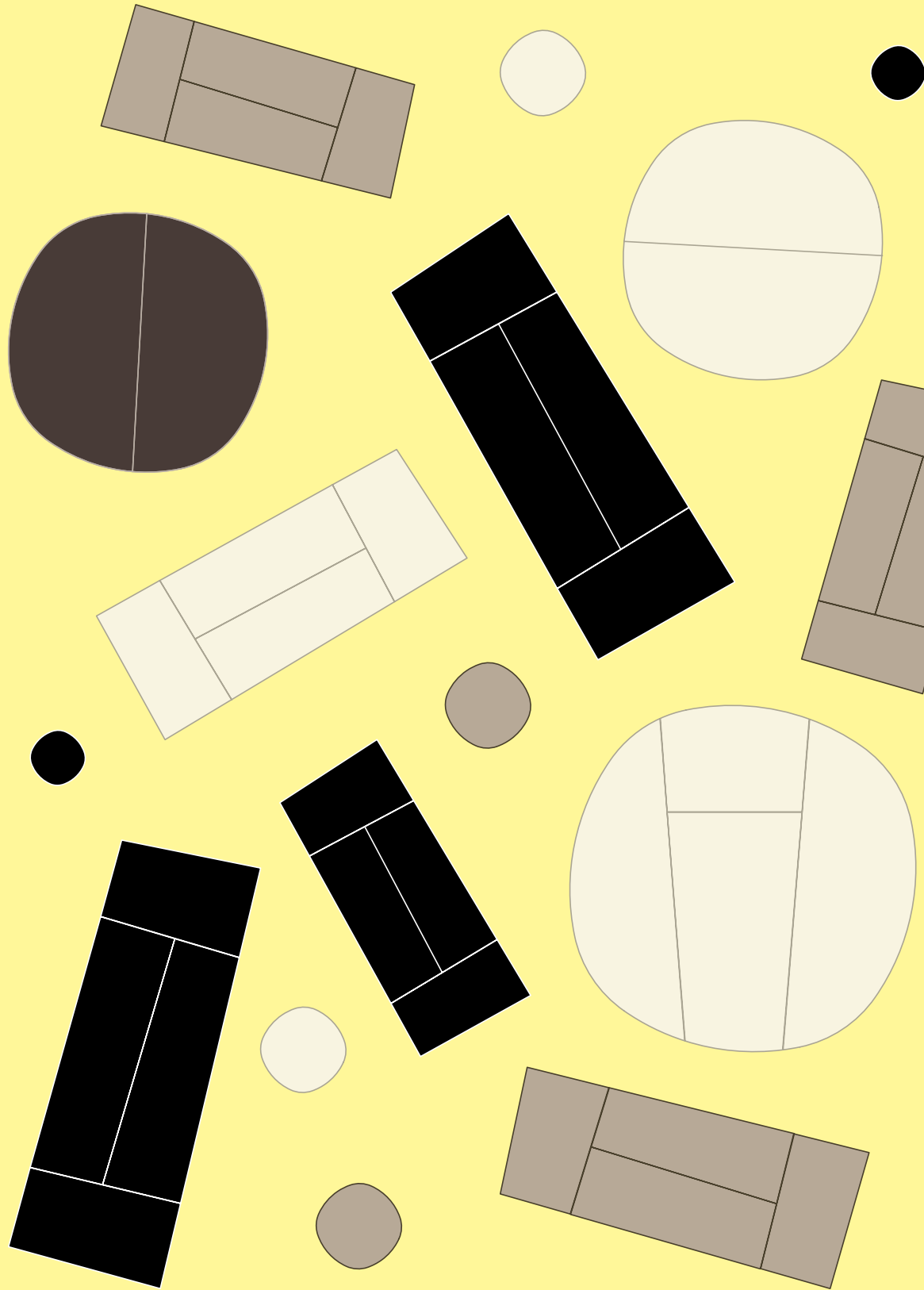

Asymmetrical
Wind, Roma (Italy), 2007



The meeting tables, with their wood or lacquer surfaces, can be combined with lacquer or marble bases.

I tavoli riunione, disponibili con piani in essenza o laccato, possono essere abbinati a basi in laccato o in marmo.

Asymmetrical



Asymmetrical
RHGR, Madrid (Spain), 2009



Vara

Design:
Luca Scacchetti
2013



Desks, meeting tables in a variety of sizes and containers, Vara is a collection with a strong visual impact, which also offers unlimited personalisation options for bespoke projects. The Latin origin of the name recalls the form of the classic carpenter's sawhorse: a reference to craftsmanship which is reflected in the play of perfectly balanced volumes over which the surfaces seem to float in the air. Wirings are routed through the legs, in a precise synthesis of form and function.

Scrivanie, tavoli meeting di diverse dimensioni, contenitori, Vara è una collezione dal forte impatto visivo, che garantisce al tempo stesso una vasta possibilità di personalizzazioni da realizzare a progetto. L'etimologia latina del nome rimanda alla forma del classico cavalletto da banco del falegname: una memoria legata all'artigianalità ripresa nel gioco di volumi in equilibrio in cui i piani sembrano sospesi nel vuoto. I sistemi di elettrificazione scorrono celati nelle gambe in una precisa sintesi di forma e funzione.

The collection is characterised by the combination of electrocoloured satin finished nickel and lacquered surfaces, while the carved dished top in dyed oak has clearly shaped borders, with rigorous geometric styling, finished in leather and oxide ceramic.

La collezione è caratterizzata dall'accostamento tra il nichel satinato elettrocolore e superfici laccate mentre la vasca in rovere tinto definisce i bordi dei piani, rigorosamente geometrici, in pelle e ceramica oxide.





Design:
Luca Scacchetti
1988



A family of individual workstations, with open or panelled bases, containers and small or large meeting tables. The classic styling transmits a sophisticated prestige, enhanced by the use of hand-crafted solid wood, in a wide range of finishes and sizes.

Una famiglia di postazioni individuali, con base aperta o pannellata, contenitori e piccoli o grandi tavoli meeting. La linea classica trasmette un sofisticato effetto di importanza e prestigio esaltato dall'utilizzo del legno massello lavorato artigianalmente, offrendo un'ampia scelta di finiture e di dimensioni da realizzare a progetto.

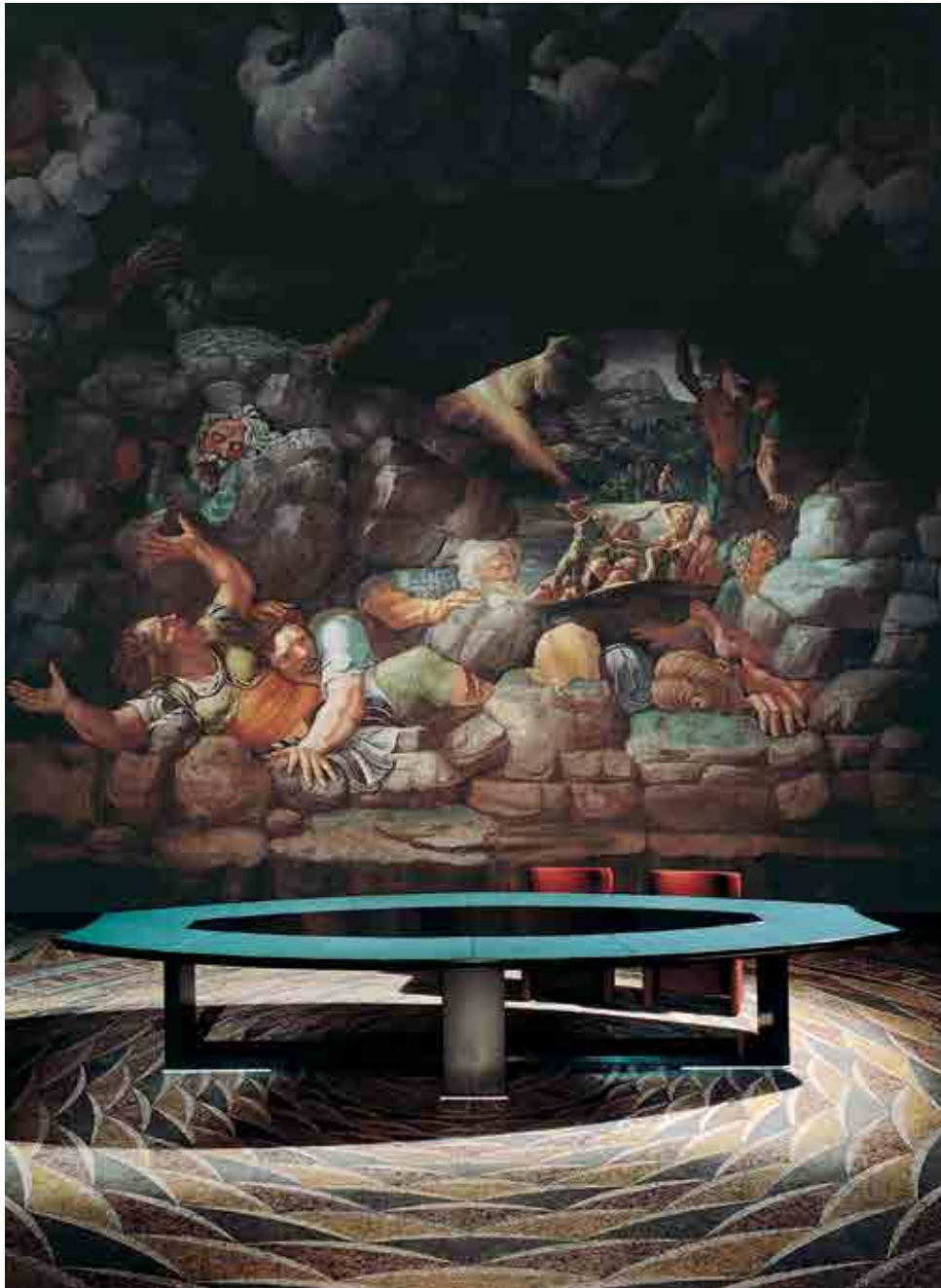

“Ianus, the God of renewal, has two faces, one looking to oncoming events, and the other looking to the past. Actually, every new fact roots back into the “past”. Avant-garde approach and formal research stay in his field of vision as different opportunities. Most straightforwardly, Ianus puts aside age-old controversies and asks a piece of furniture to be what it is: not just a theory.”

“Ianus, il dio di ciò che si rinnova, guarda con una faccia ciò che viene; con l'altra, ciò che precede. Niente, infatti, è veramente nuovo se non ha un “prima” dietro di sé. Avanguardia e ricerca formale stanno nel suo campo visivo come opportunità diverse. Con naturalezza si spoglia di dibattiti annosi per chiedere a un mobile di essere un mobile: non una teoria.”



lanus tables and desks have wood or lacquered tops, and can be fitted with leather blotter.

I tavoli e le scrivanie lanus prevedono piani in legno o laccato con possibilità di sottomano in pelle nei colori di collezione.



Ianus Top 5:

1° 11 x 3 m (36 x 10 ft)
Assicurazioni Generali

2° 10 x 3 m (33 x 10 ft)
Eurazeo

3° 10 x 2,5 m (33 x 8 ft)
*CCR - Compagnie de
Contractants Régionaux*

4° 10 x 2 m (33 x 7,5 ft)
*Aircraft Manufacturer
Company*

5° 9 x 4 m (30 x 13 ft)
Private Company





With its panelled base, laquered-finished carved dished top and leather blotter, lanus offers maximum degree of customization.

Grazie alla base pannellata e al piano a vasca in laccato con sottomano in pelle, lanus permette il massimo grado di personalizzazione da realizzare a progetto.

The products can be supplemented with technological solutions, including audio-video equipment, again with the characteristic shaped solid wood edge.

È possibile accessoriare tecnologicamente i prodotti con l'integrazione di soluzioni audio-video, sempre contraddistinte dal caratteristico bordo in massello sagomato.

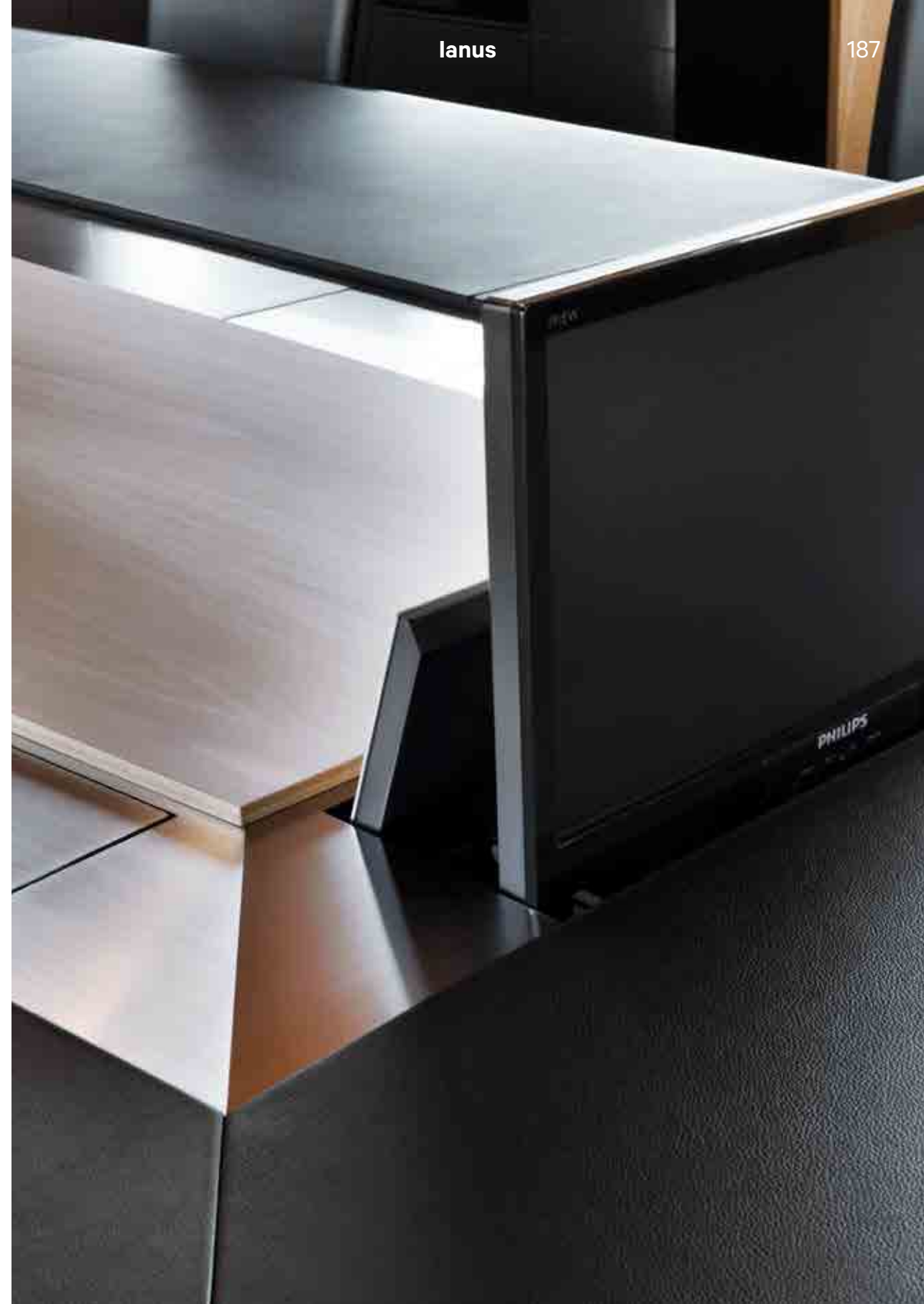





Design:
Norman Foster
 2011

The collection includes a table, bookcase and container, expressive of a more informal, softer approach to executive office furnishings. Its unusual sinuous geometry is well suited to both the conventional workplace and the home office. All tops and shelves have rounded borders, while the organically formed bases, made with Cristalplant, provide space for routing electrical cables.

Collezione composta da tavolo, libreria e contenitore che esprime un approccio più informale e soft all'arredo degli uffici executive. La geometria inaspettata e sinuosa delle forme si adatta sia a contesti di lavoro tradizionale che a situazioni di home-office. Tutti i piani e i ripiani sono caratterizzati da una lavorazione del bordo a smusso mentre le basi di forma organica, ottenute grazie dall'utilizzo del Cristalplant, permettono il passaggio interno dell'elettrificazione.





The collection stands out for its matt-white finished bases, lacquered components and the use of light oak wood.

La collezione è caratterizzata dalla finitura bianca opaca di basi e componenti laccate o dall'uso del legno in finitura rovere pallido.



T334 T335

Design:
Centro Progetti Tecno
 1975

Large meeting tables: the tops are formed of arc-shaped segments connected together, softly united at the ends and slight convex in the central section.

The fine polyester lacquer (4 layers) is brushed to obtain an especially brilliant shine. This is complemented by an internal layer of wood veneer to ensure that the lacquer is particularly even and provide a more secure grip.

Grandi tavoli riunione: le sagome dei piani sono formate da porzioni di circonferenza collegate tra loro, morbidamente raccordate sulle teste e leggermente bombate nella sezione centrale.

La fine laccatura poliestere a 4 mani con successiva spazzolatura permette di ottenere una speciale brillantezza della superficie. Mentre l'utilizzo interno di uno strato di impiallacciato di legno permette una stesura ancor più uniforme della lacca e di ottenere un grip maggiore.

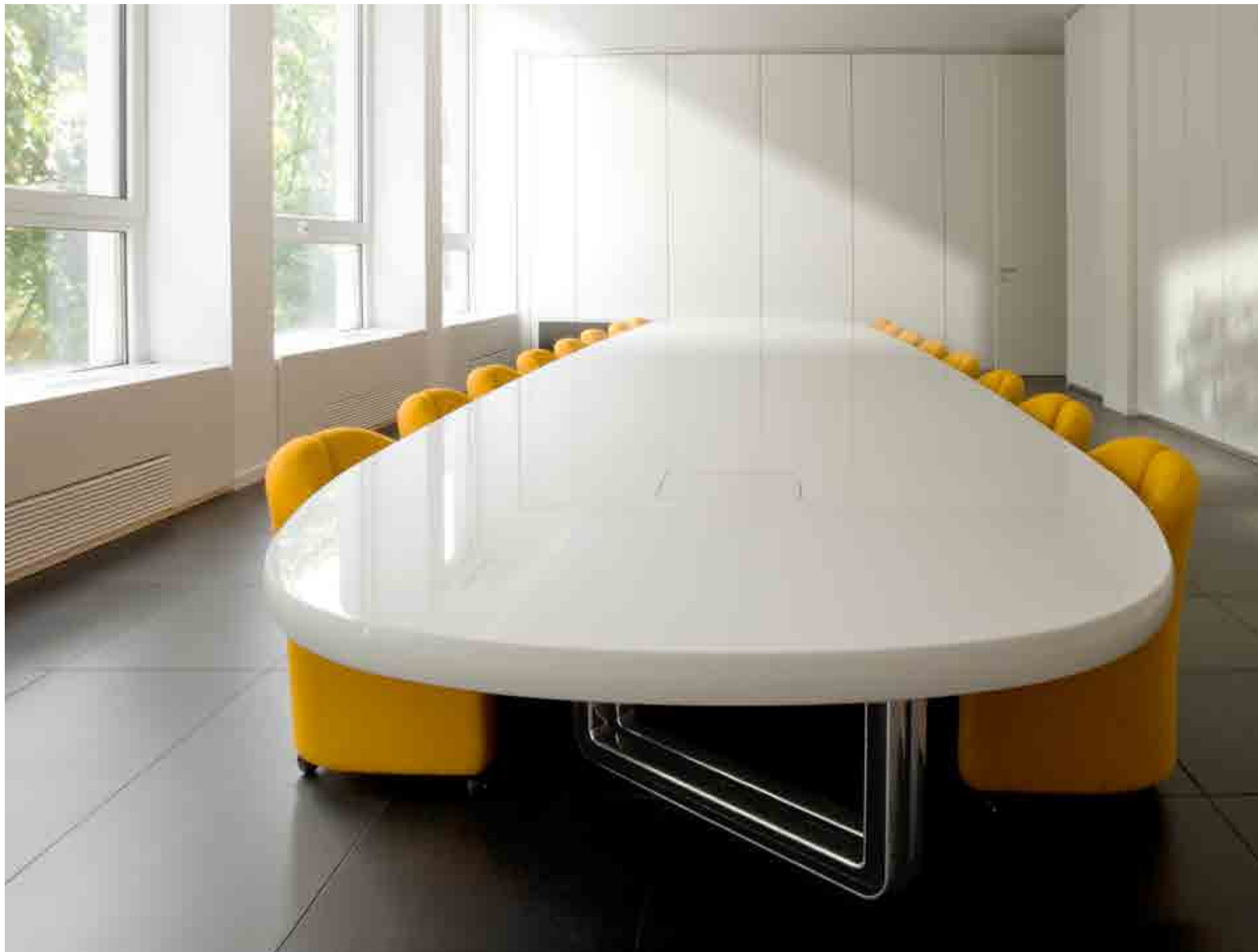



The legs, characterized by a double T aluminium cross-section, are mirror finished and internally painted with black colour to accentuate their unique shape. The large table tops are highlighted by delicate aluminium joints that outline each segment.

Le gambe, caratterizzate da una sezione a doppia T, sono in alluminio lucidato a specchio e verniciate internamente in nero, per accentuarne la forma unica.

La riconoscibilità dei grandi tavoli è garantita dalle delicate giunzioni in alluminio che corrono tra i segmenti del piano.





Détabilisation

Design:
François e Frédéric Morellet
1991

Tables with a strongly geometrical design which recalls deconstructionalism, Détabilisation is the result of an eclectic study of minimalist and conceptual art.

Tavoli dalla linea decisamente geometrica che rimanda al decostruttivismo, Détabilisation è il risultato di un'indagine eclettica nel campo dell'arte minimalista e concettuale.



The table features one or two bases which outline a 3D cubic volume in false imbalance, over which floats a light transparent top.

Il tavolo si sintetizza in una struttura formata da una o due basi che configurano un volume cubico tridimensionale in apparente disequilibrio, a cui viene sovrapposto un sottilissimo piano trasparente.





Chairs are involved in every part of our daily work, whether at the desk, in discussions and meetings, during moments of relaxation and informal exchanges. A complete panorama of materials and versions for collections with a diversified character, able to speak a variety of design languages.

Le sedute accompagnano ogni attività della giornata: il lavoro operativo alla scrivania, i momenti di confronto e riunione, le pause relax, gli scambi informali. Un panorama completo di materiali e un'ampia disponibilità di versioni per collezioni dal carattere eterogeneo, che declinano diversi linguaggi progettuali.

Seating
Sedute

Serie 142 220

Serie 148 221

Plau 228

Modus 234

Vela 240

Qualis 248

P08 254

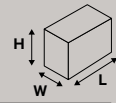
**Serie 142** pag. 220

PS142 low armchair on feet or castors
Poltroncina bassa PS142 su piedini o ruote
L 68 cm, W 60 cm, H 68 cm
L 26 3/4", W 23 3/4", H 26 3/4"

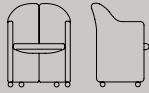

S142 high armchair on feet or castors
Poltroncina alta S142 su piedini o ruote
L 57 cm, W 56 cm, H 82 cm
L 22 1/2", W 22", H 32 1/2"

Serie 148 pag. 221

PS148 low armchair on feet or castors
Poltroncina bassa PS148 su piedini o ruote
L 64 cm, W 64 cm, H 72 cm
L 25 1/2", W 25 1/2", H 28 3/4"

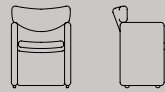

S148 high armchair on feet or castors
Poltroncina alta S148 su piedini o ruote
L 58 cm, W 56 cm, H 80 cm
L 22 3/4", W 22", H 31 1/2"



Low armchair on feet or castors
Poltroncina bassa su piedini o ruote
L 56 cm, W 58 cm, H 68 cm
L 22", W 22 3/4", H 26 3/4"



High armchair on feet or castors
Poltroncina alta su piedini o ruote
L 56 cm, W 51 cm, H 68 cm
L 22", W 20", H 29 3/4"

Modus pag. 234

Armchair on 4 legs
Poltroncina su 4 gambe
L 65 cm, W 59 cm, H 75 cm
L 25 3/4", W 23 3/4", H 29 1/2"



Stackable and attachable chair
Seduta impilabile ed agganciabile
L 53 cm, W 53 cm, H 71 cm
L 21", W 21", H 28"



Stackable and attachable chair with armrests
Seduta con braccioli impilabile ed agganciabile
L 61 cm, W 53 cm, H 72 cm
L 24", W 21", H 28 3/4"



Height-adjustable swivel chair on feet or castors
Sedia girevole regolabile in altezza su piedini o ruote
L 48 cm, W 51 cm, H 69-82 / 75-88 cm,
L 19", W 20", H 27 1/2-32 1/2 / 29 1/2-34 3/4"



Height-adjustable swivel chair with armrests on feet or castors
Seduta girevole regolabile in altezza con braccioli, su piedini o ruote
L 56 cm, W 51 cm, H 69-82 / 75-88 cm,
L 22", W 20", H 27 1/2-32 1/2 / 29 1/2-34 3/4"

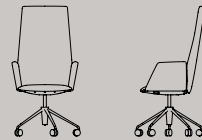

High-back executive seat with upholstered or aluminium armrests, height-adjustable 5-spoke swivel base on castors
Seduta executive schienale alto con bracciolo rivestito o in alluminio, base girevole su ruote a 5 razze con regolazione di altezza
L 67 cm, W 75-98 cm, H 117-128 cm
L 26 1/2", W 29 1/2-38 3/4", H 46-50 1/2"



Medium-back executive seat with upholstered or aluminium armrests, height-adjustable 5-spoke swivel base on castors
Seduta executive schienale medio con bracciolo rivestito o in alluminio, base girevole su ruote a 5 razze con regolazione di altezza
L 67 cm, W 71-87 cm, H 97-108 cm
L 26 1/2", W 28-34 1/4", H 38 1/4-42 1/2"



Low-back executive seat with upholstered or aluminium armrests, height-adjustable 5-spoke swivel base on castors
Seduta executive schienale basso con bracciolo rivestito o in alluminio, base girevole su ruote a 5 razze con regolazione di altezza
L 67 cm, W 65-75 cm, H 76-87 cm
L 26 1/2", W 25 3/4-29 1/2", H 30-34 1/4"

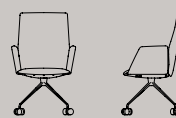

Medium-back conference seat with upholstered or aluminium armrests, 4-spoke fixed base on castors
Seduta conference schienale medio con bracciolo rivestito o in alluminio, base fissa a 4 razze su ruote
L 63 cm, W 65-81 cm, H 100 cm
L 25", W 25 3/4-32", H 39 1/2"



Medium-back conference seat with upholstered or aluminium armrests, 4-spoke swivel base on feet
Seduta conference schienale medio con bracciolo rivestito o in alluminio, base girevole a 4 razze su piedini
L 63 cm, W 65-81 cm, H 100 cm
L 25", W 25 3/4-32", H 39 1/2"



Medium-back conference seat with upholstered or aluminium armrests, 4-spoke automatic-return base on feet
Seduta conference schienale medio con bracciolo rivestito o in alluminio, base con ritorno automatico a 4 razze su piedini
L 63 cm, W 65-81 cm, H 100 cm
L 25", W 25 3/4-32", H 39 1/2"



Low-back conference seat with upholstered or aluminium armrests, 4-spoke fixed base on castors
Seduta conference schienale basso con bracciolo rivestito o in alluminio, base fissa a 4 razze su ruote
L 63 cm, W 60-70 cm, H 81 cm
L 25", W 23 3/4-27 3/4", H 32"



Low-back conference seat with upholstered or aluminium armrests, 4-spoke swivel base on feet
Seduta conference schienale basso con bracciolo rivestito o in alluminio, base girevole a 4 razze su piedini
L 63 cm, W 60-70 cm, H 81 cm
L 25", W 23 3/4-27 3/4", H 32"



Low-back conference seat with upholstered or aluminium armrests, 4-spoke automatic-return base on feet
Seduta conference schienale basso con bracciolo rivestito o in alluminio, base con ritorno automatico a 4 razze su piedini
L 63 cm, W 60-70 cm, H 81 cm
L 25", W 23 3/4-27 3/4", H 32"



Low-back visitors seat with cantilever base
Seduta visitors schienale basso, base cantilever
L 56 cm, W 56 cm, H 81 cm
L 22", W 22", H 32"

Qualis pag. 248

Low-back visitors seat with sled base
Seduta visitors schienale basso, base slitta
L 60 cm, W 56 cm, H 81 cm
L 23 3/4", W 22", H 32"



Low-back visitors seat with 4-legged base
Seduta visitors schienale basso, base a 4 gambe
L 55 cm, W 56 cm, H 81 cm
L 21 3/4", W 22", H 32"



Low armchair with adjustable backrest or swinging mechanism, fixed or height-adjustable, swivel base on castors
Poltroncina bassa con articolazione dello schienale o movimento oscillante, ad altezza fissa o regolabile, base girevole con ruote
L 54 cm, W 64 cm, H 88-101 cm
L 21 1/4", W 25 1/4", H 34 3/4-39 3/4"

P08 pag. 254

Low armchair with adjustable backrest or swinging mechanism, fixed or height-adjustable, swivel base on castors, complete with armrests
Poltroncina bassa con articolazione dello schienale o movimento oscillante, ad altezza fissa o regolabile, base girevole con ruote, completa di braccioli
L 64 cm, W 64 cm, H 88-101 cm
L 25 1/4", W 25 1/4", H 34 3/4-39 3/4"



High armchair with adjustable backrest or swinging mechanism, height-adjustable, swivel base on castors, complete with armrests
Poltroncina alta con articolazione dello schienale o movimento oscillante, ad altezza regolabile, base girevole con ruote completa di braccioli
L 64 cm, W 66 cm, H 114-126 cm
L 25 1/4", W 26", H 45-49 3/4"



Folding chair
Sedia pieghevole
L 52 cm, W 58 cm, H 74 cm
L 20 1/2", W 22 3/4", H 29 1/4"

Serie 142 220

Serie 148 221

Plau 228

Modus 234

Vela 240

Qualis 248

P08 254

Serie 142

Design:
Eugenio Gerli
1966

Armchairs which combine the soft comfort of upholstery with graphic forms with a strong identity. The collection includes both the S142 armchair, taller and more structured, and the PS142 model, in a lower, more encircling form.

Poltroncine che coniugano il morbido comfort dei materiali imbottiti con forme grafiche e identificative. La collezione si declina sia in versione poltroncina S142, più alta e sostenuta, sia in versione poltrona PS142, più bassa e avvolgente.



Serie 148

Design:
Centro Progetti Tecno
1980

Upholstered armchairs with square, minimal styling, available in the S148 variant, taller and more structured, ideal for the dinner table or conference rooms, and the PS148 version, with its lower, rounder form, better suited to living rooms, waiting rooms and informal settings.

Poltroncine imbottite dalla linea squadrata e minimale proposte nella variante S148 più alta e sostenuta da tavolo o riunione, o in quella PS148 più bassa e avvolgente da salotto, attesa o conversazione.



Serie 142, Serie 148
Wind, Rome (Italy), 2007



Serie 142, Serie 148
La Rinascente, Milan (Italy), 2008



Virgin Milan Headquarters interior.
Interno della sede Virgin a Milano.





Plau

Design:
Gabriele e Oscar Buratti
 2012

An origami armchair born as a single padded sheet, cut and bent to create the seat. Offered in a relaxation version or a higher table model, the enveloping shape makes it ideal for home settings, around a dining table or accompanying sofas in the living area, but equally suited to offices and contract spaces such as meeting and waiting areas.

Poltroncina origami che nasce come un unico foglio piano e imbottito, tagliato e poi piegato per formare il pozzetto.

La geometria avvolgente e comoda si declina nella versione tavolo o relax inserendosi nel paesaggio domestico, attorno al tavolo da pranzo o abbinata ai divani nella zona living o negli spazi di lavoro e contract, come aree meeting, di attesa e lounge.

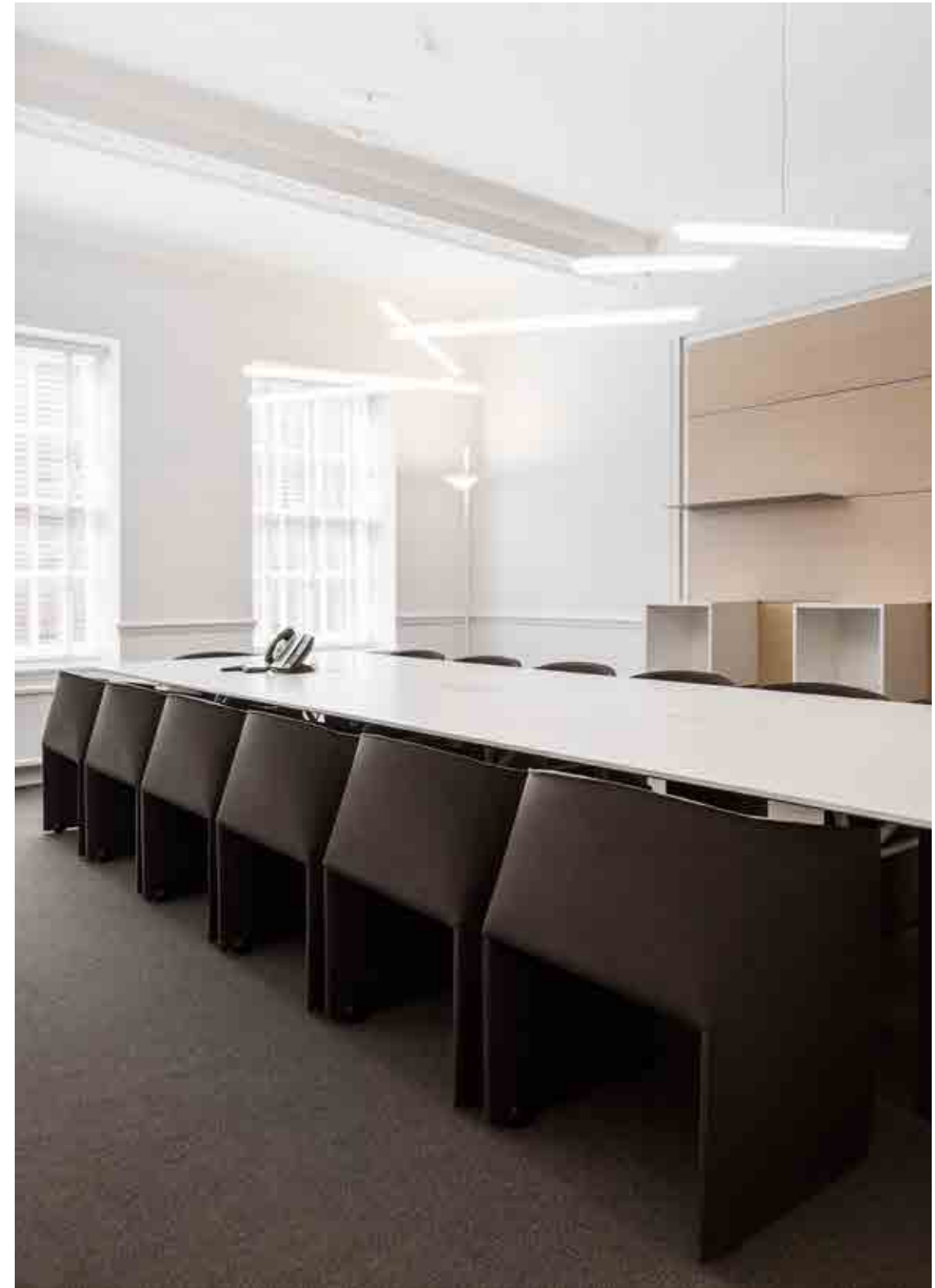



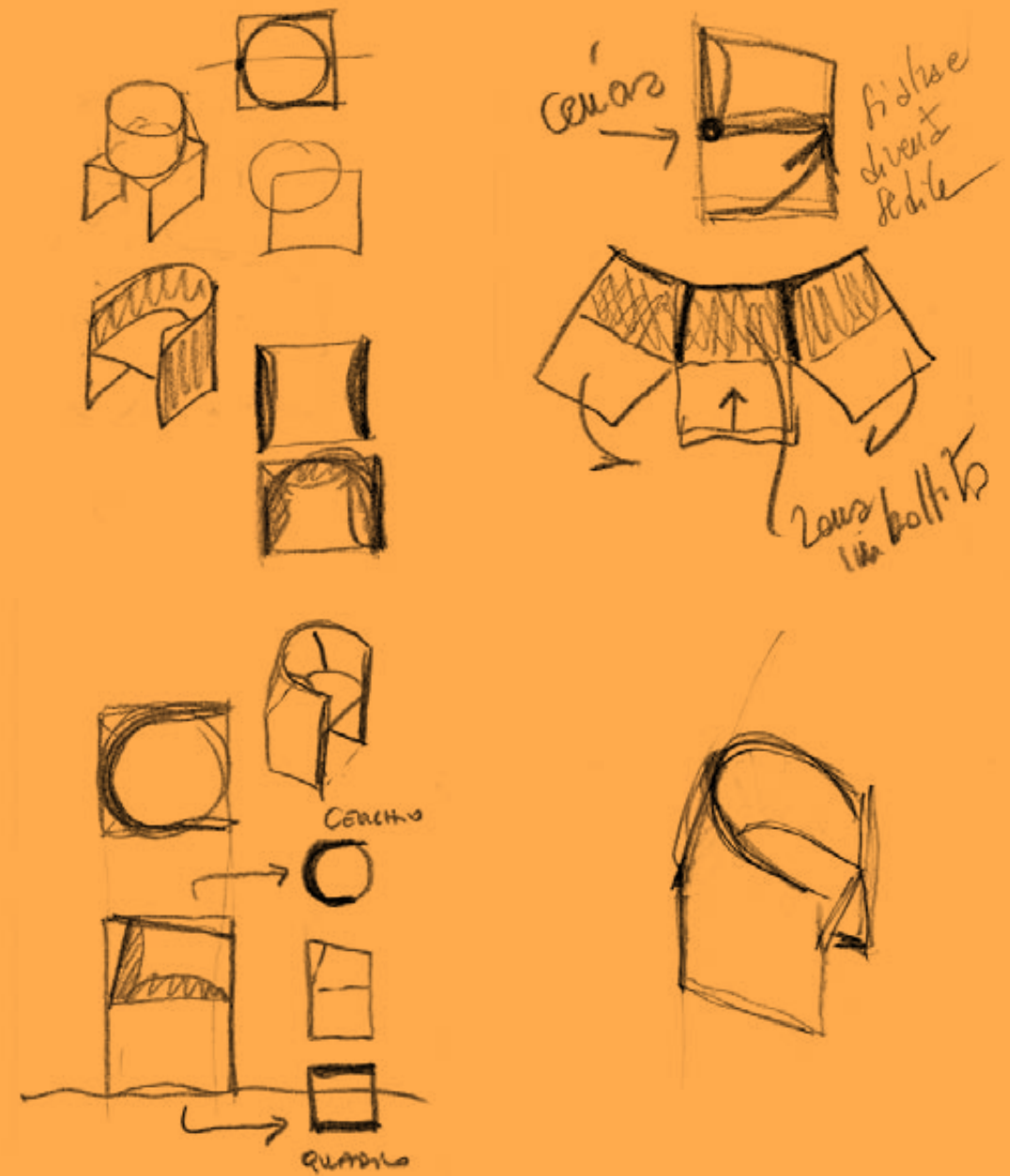

2012. Origami chair.
2012. Seduta origami.

Modus

Design:
Centro Progetti Tecno
 1972

An iconic chair, one of the first to use plastic for office furniture. The choice of injection cast nylon makes the body pleasing to touch and look at, ensuring high mechanical resistance. The characteristic “spider” frame connects the seat to the semi-circular mirror finished aluminium base which is painted black internally to enhance its visual impact.

Sedia iconica tra le prime a prevedere l'uso dei plastici nel mondo dell'arredo ufficio. La scelta di utilizzare il nylon fuso a iniezione rende la texture della scocca piacevole al tatto e alla vista, garantendo un'elevata resistenza meccanica. La caratteristica struttura “a ragno” connette la scocca alla base che si apre a formare un semicerchio in finitura alluminio lucidato a specchio all'esterno e verniciato nero nella parte interna per un effetto visivo più slanciato.





Modus is available in the stackable version on trestle frame base or as swivel chair with height adjustment and 5 spoke base. Arm rests, wheels or fixed feet are available, and padding can be added to the seat alone or to both seat and backrest.

Modus è disponibile in versione impilabile e agganciabile su base singola a cavalletto o girevole con regolazione dell'altezza su base a 5 razze. È possibile prevedere i braccioli, scegliere tra ruote o piedini, aggiungere l'imbottitura su seduta o su entrambi seduta e schienale.





1994. Lingotto Convention Center, Turin.
1994. Centro Congressi Lingotto, Torino.

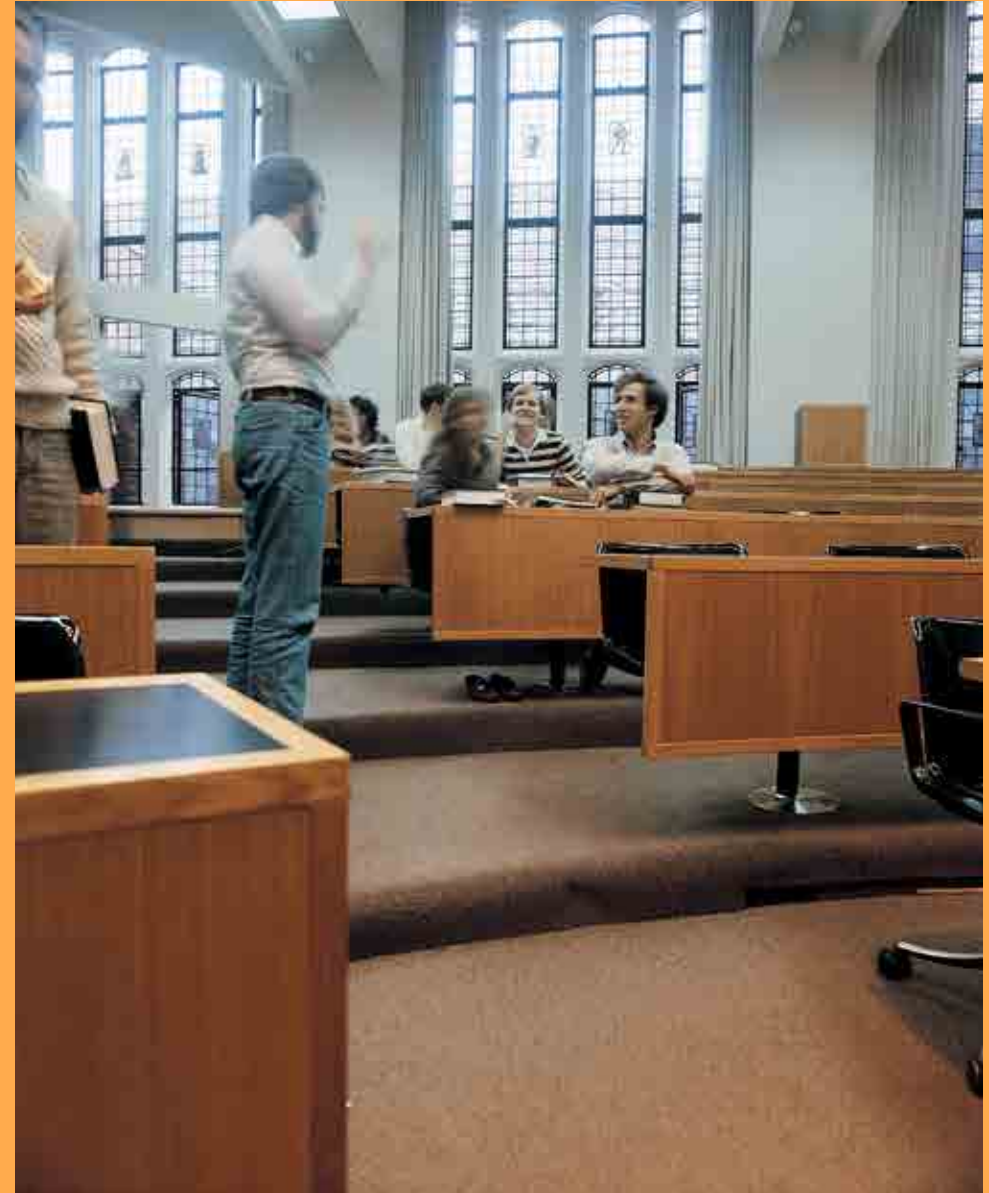

1982. Yale University.
1982. Università di Yale.

Vela

Design:
Lievore Altherr Molina
2014

A family of seats with a simple and elegant design that conceals a sophisticated responsive mechanism able to automatically adapt comfort and posture based on the weight of the user.

Famiglia di sedute dal design semplice ed elegante che cela un sofisticato meccanismo responsive in grado di adattare automaticamente comfort e postura in base al peso dell'utilizzatore.

The collection, conceived for office, soft-contract and residential spaces, is available with sled and cantilever base, with 4 legs in wood or 4 and 5 spoke swivel on feet or fixed on castors. The spokes are made by pushing metal manufacturing to its limits: tapered steel tubes, cold-formed with a variable cross section, are at the end elegant, lightweight supporting frames.

La collezione, concepita per inserirsi in ambienti ufficio, soft-contract e spazi residenziali, è disponibile nelle versioni slitta, cantilever, 4 gambe in legno, 4 e 5 razze girevoli oppure con sistema di autoritorno su piedini o fissa su ruote con bracciolo imbottito o in alluminio. La struttura a razze è stata concepita esasperando la tecnologia di lavorazione del metallo: tubi di acciaio conificati, stampati a freddo a sezione variabile, si trasformano in leggere ed eleganti basi di sostegno.





All adjustments are controlled by invisible dedicated leverage located below the seat.

Nelle diverse versioni disponibili, le regolazioni della seduta avvengono grazie a un comando integrato nella base dei sedili, comodo da raggiungere e poco visibile.

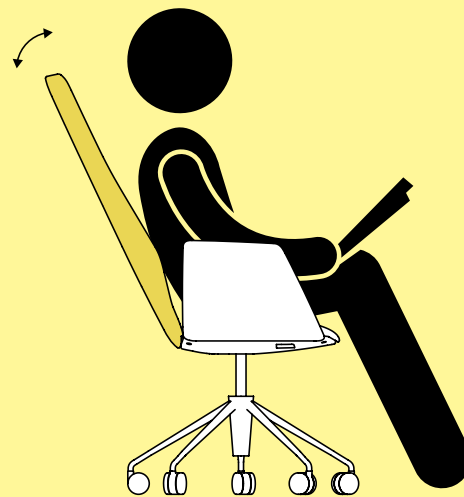
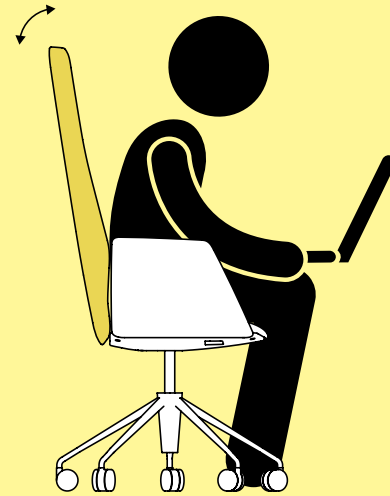

The various versions of the seat comply with the requirements of UNI EN 1335 type B and UNI EN 16139. Vela uses polyurethane compliant with BS 5852. It is also available in BIOH polyurethane on request.

La seduta, nelle diverse versioni, risponde alle normative UNI EN 1335 tipo B e UNI EN 16139. Vela utilizza poliuretano conforme alla normativa BS 5852. Ad esigenza può essere utilizzato poliuretano BIOH.





Qualis

Design:
Emilio Ambasz
 1991



Executive and workstation chairs with tailored upholstery. The seat results particularly comfortable thanks to the thin padded cushions realized with a lateral bellow. The articulating backrest is specifically patented for integration into the subtle shape. The chairs are available with and without PVC armrests, fixed height or adjustable, and optionally with a 3-position lockable tilt. The 5 spoke steel base is covered with a shell made of polypropylene or in polished, die-cast aluminium.

Sedute direzionali e operative con un rivestimento sartoriale della scocca. La seduta è particolarmente confortevole grazie ai sottili cuscini d'imbottitura, che formano un soffietto lungo l'intero profilo laterale, e al meccanismo di articolazione dello schienale, brevettato appositamente per essere integrato al meglio nella struttura. Le sedute possono essere con o senza braccioli in PVC, ad altezza fissa o regolabile ed eventualmente con movimento oscillante e blocco in 3 posizioni. La base a 5 razze in acciaio è coperta da un carter realizzato in PVC o in pressofusione di alluminio lucidato.



1991. Lateral essential drawing.

1991. Disegno laterale rappresentativo.



1991. Qualis dressed up with special fabrics.

1991. Qualis vestita di tessuti particolari.



P08

Design:
Justus Kolberg, Centro Progetti Tecno
 1991



A minimalist folding chair, designed for combination in rows; the profile is very thin and the seat, once closed, fits in a space of just 9 cm / 3 ½ ". The structure is made of satin-finish stainless steel while the seat and backrest are made of polyamide painted black. Up to 6 chairs can be hung on the wall using accessory hooks.

Sedia pieghevole, essenziale e con una forma perfettamente componibile in sequenza; il profilo è particolarmente sottile e la sedia, una volta chiusa, richiede un ingombro di soli 9 cm. La struttura è costituita da piatte in acciaio inox satinato mentre il sedile e lo schienale sono in poliammide verniciato nero. È possibile stoccare a muro fino a 6 sedie grazie agli appositi ganci accessori.



1991. Dynamic picture of the chair opening and closure.
1991. Foto dinamica di apertura e chiusura della seduta.

Hyper-connected, high occupation offices designed for exchange and sharing require hybrid, welcoming spaces, as suited to discussion as they are to the need for privacy. Even waiting areas can be given a more orderly, institutional character or act as informal lounge areas, furnished with loosely structured compositions.

Uffici iper-connessi, intensamente frequentati e orientati alla condivisione necessitano di spazi ibridi e accoglienti, dedicati ai momenti di relazione o pensati per le necessità di privacy. Anche le aree di attesa possono avere un carattere più ordinato e istituzionale oppure diventare lounge rilassanti arredate da composizioni destrutturate e informali.

**Upholstered
and accessories
Imbottiti
e complementi**

Todo Modo 266

Archipelago 274

Pons 282

Laetitia 290

Aura 298

P32 306

Solenoidi, T1 T2 314

AT16 318

P31 324

P40, D70 330

T69 338

T90 342

Hortus, T50 344

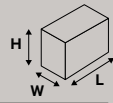
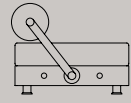
Todo Modo pag. 266

Seat with backrest
Seduta con schienale
L 90 cm, W 87 cm, H 71 cm
L 35 ½", W 34 ¼", H 28"

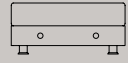

Seat without backrest
Seduta senza schienale
L 90 cm, W 87 cm, H 42 cm
L 35 ½", W 34 ¼", H 16 ½"

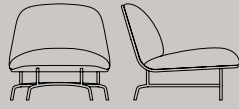
Archipelago pag. 274

Small armchair
Poltrona piccola
L 76 cm, W 84 cm, H 76 cm
L 30", W 33", H 30"

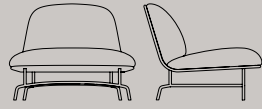

Medium armchair
Poltrona media
L 95 cm, W 86 cm, H 76 cm
L 37 ½", W 33 ½", H 30"

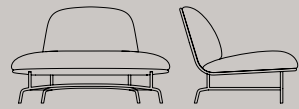

Large armchair
Poltrona grande
L 121 cm, W 86 cm, H 76 cm
L 47 ¾", W 33 ¾", H 30"

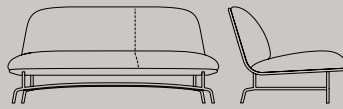

2-seater sofa, stitching on left or right
Divano 2 posti, cucitura lato destro o sinistro
L 162 cm, W 88 cm, H 76 cm
L 63 ¾", W 34 ¾", H 30"

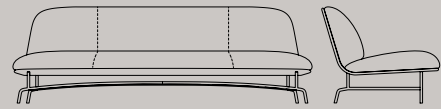

3-seater sofa
Divano 3 posti
L 230 cm, W 89 cm, H 76 cm
L 90 ½", W 35", H 30"

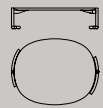

Low coffee table, first component of a system, either free-standing or with attachment to the structure of armchairs / sofas
Tavolino basso per sistema di tavolini free-standing o con aggancio alla struttura di poltrone / divani
L 61 / 75 cm, W 49 / 61 cm, H 19 cm
L 24 / 29 ½", W 19 ½ / 24", H 7 ½"

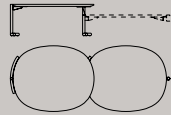

Medium coffee table
Tavolino medio
L 61 / 75 cm, W 49 / 61 cm, H 32 cm
L 24 / 29 ½", W 19 ½ / 24", H 12 ¾"

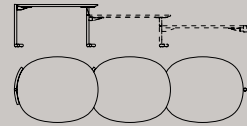

High coffee table
Tavolino alto
L 61 / 75 cm, W 49 / 61 cm, H 45 cm
L 24 / 29 ½", W 19 ½ / 24", H 17 ¾"

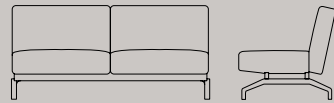
Pons pag. 282

Low-back 2-seater sofa without armrests
Divano 2 posti schienale basso senza braccioli
L 160 cm, W 81 cm, H 74 cm
L 63", W 32", H 29"

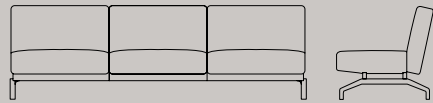

Low-back 3-seater sofa without armrests
Divano 3 posti schienale basso senza braccioli
L 240 cm, W 81 cm, H 74 cm
L 94 ½", W 32", H 29"

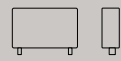

Armrest
Bracciolo
L 11 cm, W 62 cm, H 34 cm
L 4 ¼", W 24", H 13 ½"

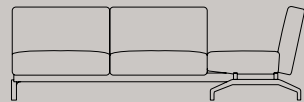

2+2-seater sofa
Divano 2+2 posti
L 251 cm, W 251 cm, H 74 cm
L 99", W 99", H 29"

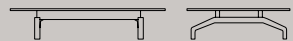

Rectangular coffee table
Tavolino rettangolare
L 120×80 cm / 160×80 cm, H 25 cm
L 47 ¼×31 ½" / 63×31 ½", H 10"



Round coffee table
Tavolino rotondo
Ø 130 cm, H 25 cm
Ø 51 ½", H 10"

Dimensions are understood to be indicative maximum dimensions Le misure si intendono indicative di massima

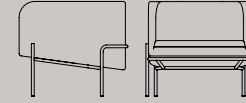
Laetitia pag. 290

Armchair
Poltrona
L 78 cm, W 79 cm, H 69 cm
L 30 ¾", W 31", H 27"

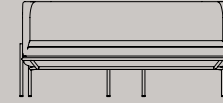

2 seater sofa
Divano 2 posti
L 150 cm, W 79 cm, H 69 cm
L 59", W 31", H 27"

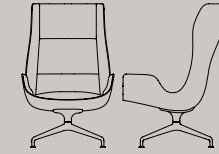
Aura pag. 298

Armchair with high backrest
Poltrona con schienale alto
L 75 cm, W 88 cm, H 117 cm
L 29 ½", W 34 ¾", H 46"

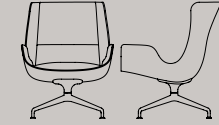

Armchair with low backrest
Poltrona con schienale basso
L 75 cm, W 88 cm, H 94 cm
L 29 ½", W 34 ¾", H 37"



Pouf
L 56 cm, W 53 cm, H 45 cm
L 22", W 21", H 18"

P32 pag. 306

Relaxing armchair
Poltrona relax
L 85 cm, W 80 cm, H 83 cm
L 33 ¾", W 31 ½", H 32 ¾"

Solenoidi pag. 314



Round coffee tables
Tavolini tondi
Ø 42 cm, H 58 cm
Ø 60 cm, H 48 cm
Ø 16 ½", H 23"
Ø 23 ¾", H 19"

T1 T2 pag. 315

T1 coffee table
Tavolino T1
Ø 26 cm, H 48 cm
Ø 10 ½", H 19"

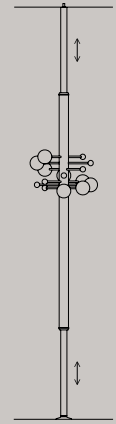

T2 coffee table
Tavolino T2
Ø 40 cm, H 62 cm
Ø 15 ½", H 24 ¾"

AT16 pag. 318

Column coat hanger
Appendiabiti a colonna
L 69 cm, W 69 cm, H 270-320 cm
L 27 ¼", W 27 ¼", H 106 ½-126"

P31 pag. 324

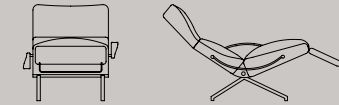

Chair
Sedia
L 57 cm, W 60 cm, H 69 cm,
L 22 ½", W 23 ½", H 27"

P40 pag. 330

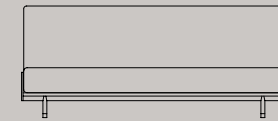
Relaxing armchair
Poltrona relax
L 72 cm, W 80-150 cm, H 70-90 cm,
L 28 ½", W 31 ½-59", H 27 ½-35 ½"

D70 pag. 331

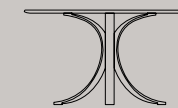
Sofa with mobile wings
Divano ad ali mobili
L 195 cm, W 90-115 cm, H 85 cm
L 76 ¾", W 35 ½-45 ½", H 33 ½"

T69 pag. 338

Round table
Tavolo tondo
Ø 130 cm, H 73 cm
Ø 51 ½", H 28 ¾"

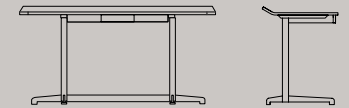
T90 pag. 342

Shaped top desk with 3 drawers
Scrivania con piano sagomato e curvato, con 3 cassetti
L 160 cm, W 62 cm, H 75 cm
L 63", W 24 ½", H 29 ½"

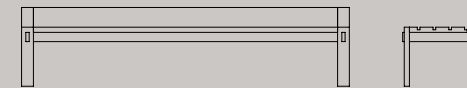
Hortus pag. 344

Bench
Panca
L 250 cm, W 58 cm, H 60 cm
L 98 ½", W 22 ¾", H 23 ¾"

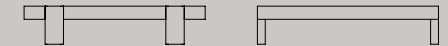
T50 pag. 345

Low coffee table
Tavolino basso
L 138 cm, W 138 cm, H 29 cm
L 240 cm, W 60 cm, H 29 cm
L 54 ½", W 54 ½", H 11 ½"
L 94 ½", W 23 ¾", H 11 ½"

Todo Modo 266

Archipelago 274

Pons 282

Laetitia 290

Aura 298

P32 306

Solenoidi, T1 T2 314

AT16 318

P31 324

P40, D70 330

T69 338

T90 342

Hortus, T50 344

Todo Modo

Design:
Jean-Michel Wilmotte
1993

Reissue:
2018

A contemporary Ottoman with a rotating and completely reversible backrest. The sofa system was born from the 1993 project for the Louvre, from the idea of setting up the rooms with a seat designed to allow visitors the viewing of artworks on every side. Today, Todo Modo finds space in waiting lounges, reception and hospitality areas, offices and co-working environments. Made with dark grey painted metal parts, it is padded with polyurethane foam covered with fabric or leather.

Un'ottomana contemporanea con schienale dal movimento rotatorio e completamente reversibile. Il sistema di divani nasce dal progetto del 1993 per il Louvre, dall'idea di allestire le sale con una seduta pensata per consentire la visione delle opere d'arte da ogni lato. Todo Modo trova oggi spazio all'interno di lounge di attesa, aree reception e accoglienza, uffici e co-working. Realizzata con parti metalliche a vista verniciate opache grigio piombo, ha l'imbottitura in schiuma poliuretana ricoperta di tessuto o pelle.





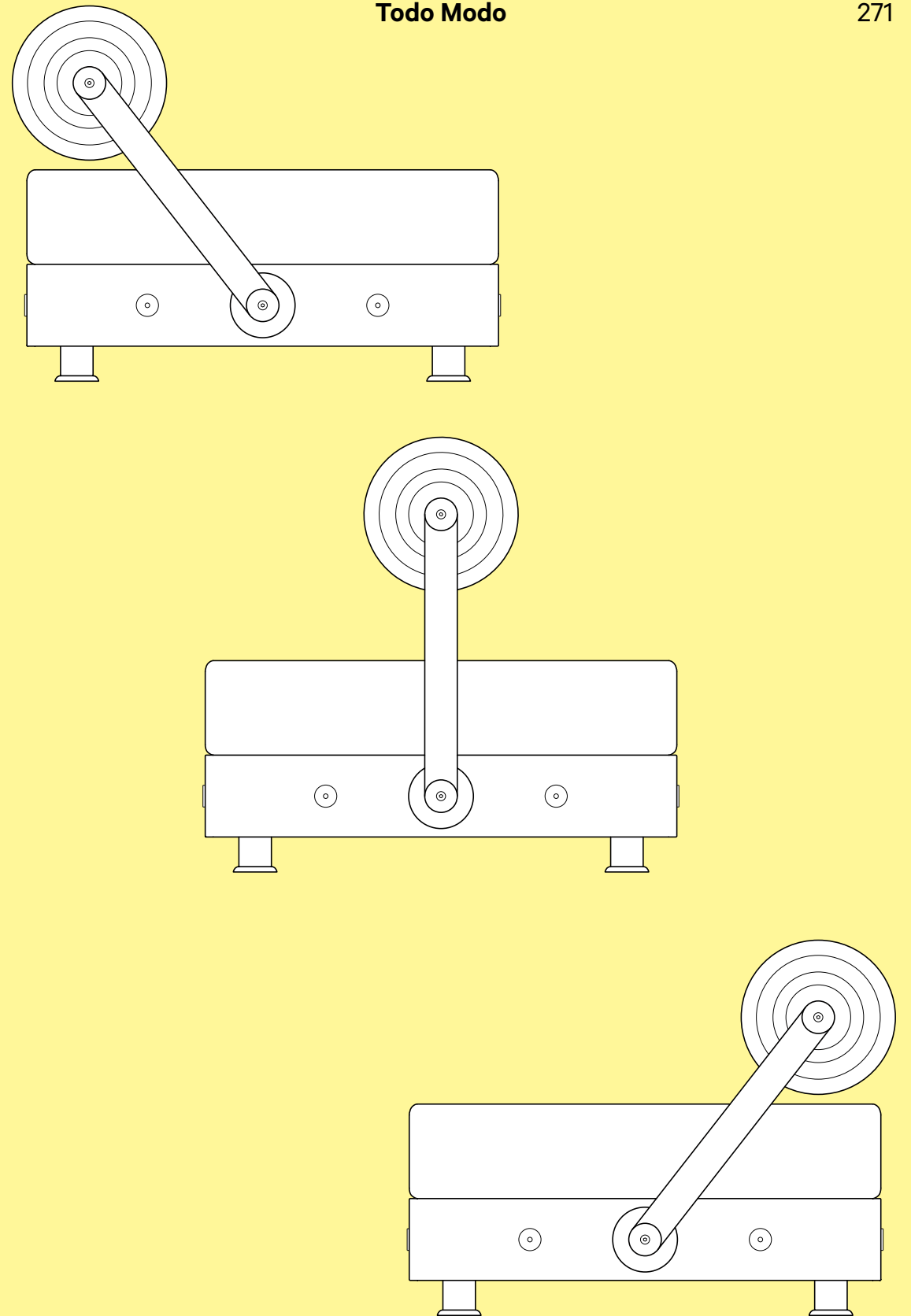
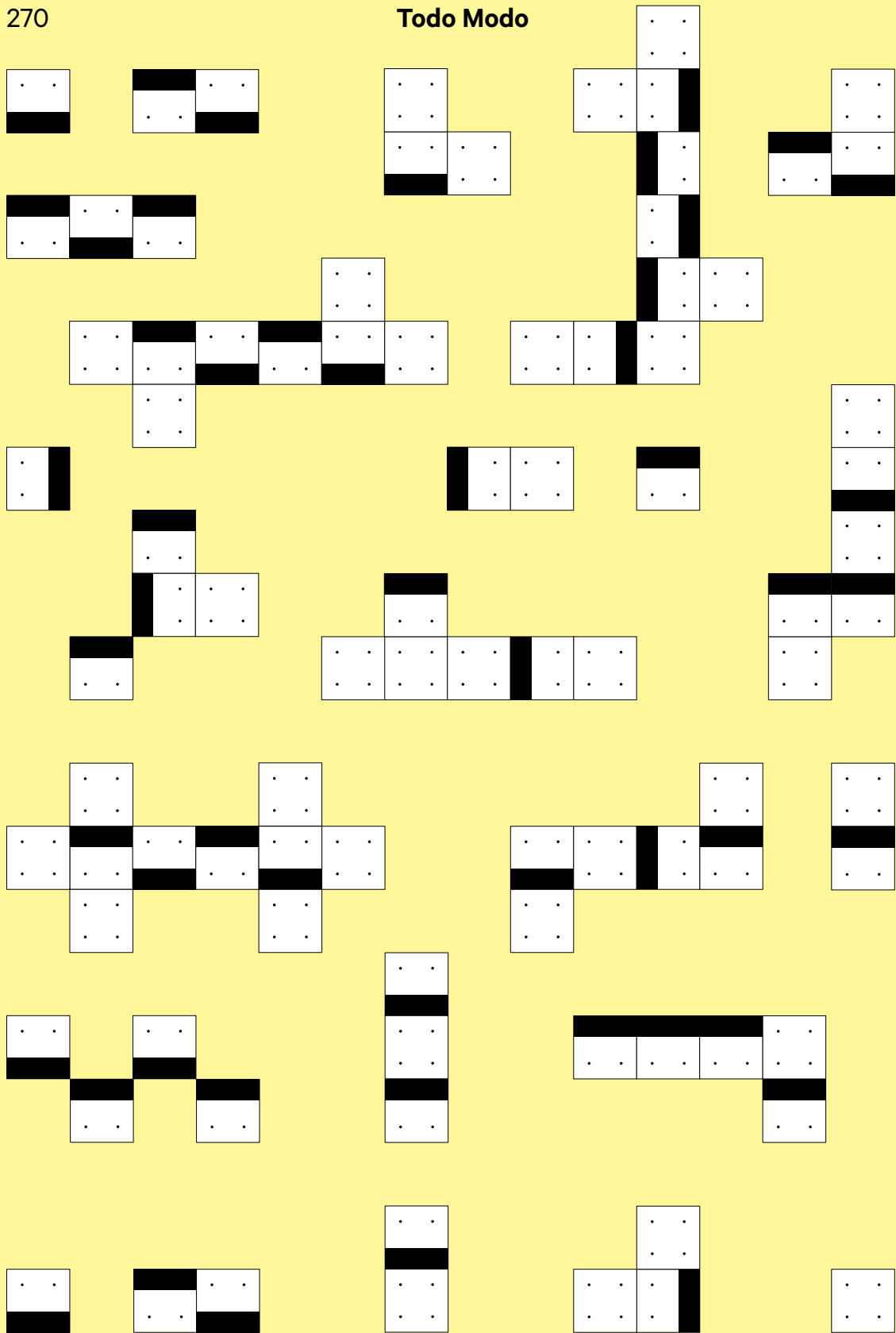



Archipelago

Design:
Monica Förster
2012

A padded seating system, small islands that can be combined or attached together in groups, creating new landscapes that can be reconfigured as desired. Instantly usable in multiple combinations, from organic shapes to more traditional compositions, to meet various needs, from offices to waiting rooms, lounges and domestic environments.

Sistema di sedute imbottite, piccole isole che si possono accostare o agganciare in gruppi, creando nuovi paesaggi riconfigurabili. La fruizione è immediata e le combinazioni sono molteplici, da forme organiche a composizioni più ordinate, per rispondere alle diverse esigenze di interior in uffici, sale di attesa, lounge, ambienti domestici.





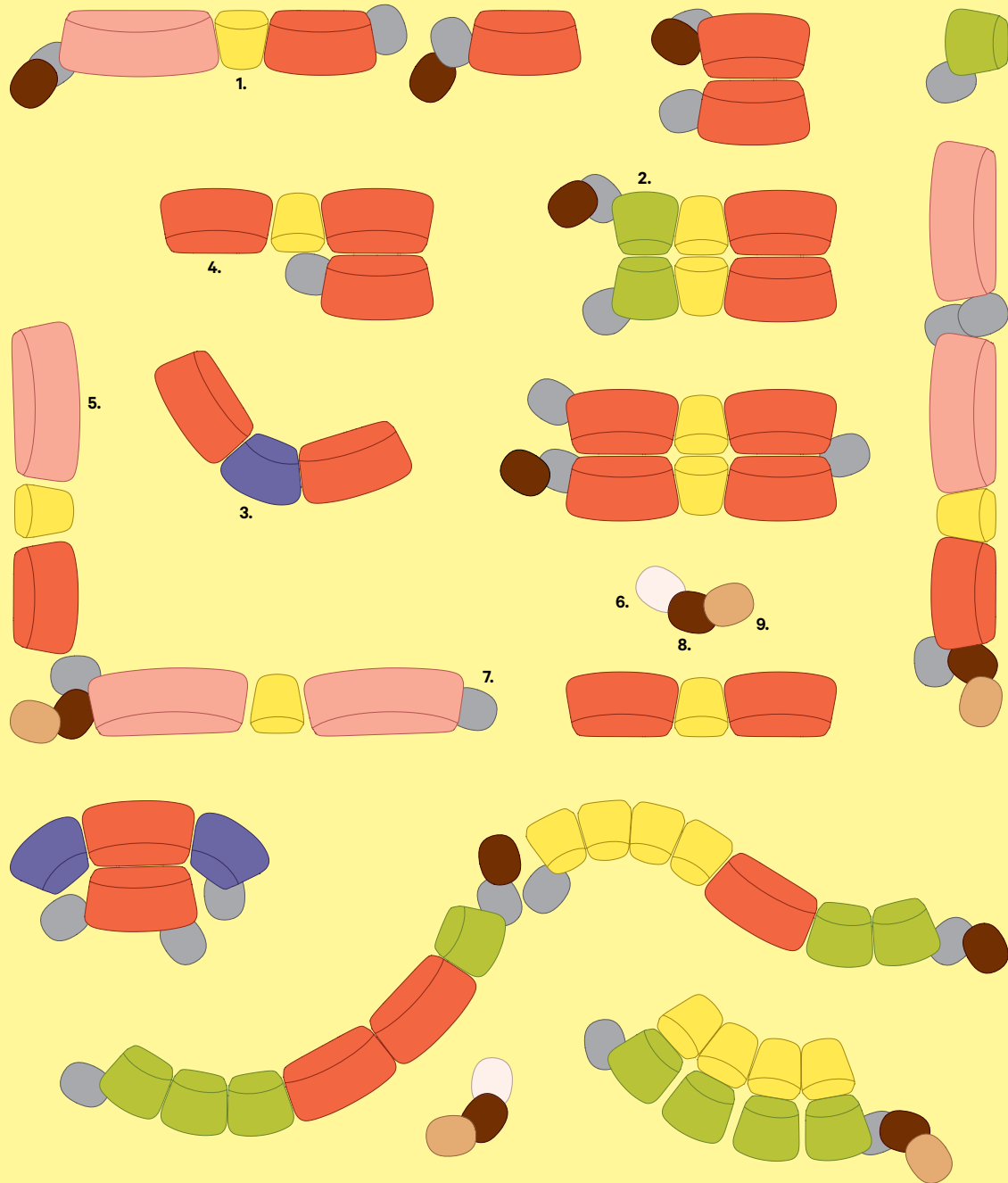

1. Small armchair
2. Medium armchair
3. Large armchair
4. 2-seater sofa
5. 3-seater sofa
6. Free-standing table
7. Low coffee table
8. Medium coffee table
9. High coffee table

1. Poltrona piccola
2. Poltrona media
3. Poltrona grande
4. Divano 2 posti
5. Divano 3 posti
6. Tavolino free-standing
7. Tavolino basso
8. Tavolino medio
9. Tavolino alto





Pons

Design:
Rodolfo Dordoni
2011

This system of beam based sofa is characterised by modularity, easy assembly and extreme flexibility, combined with a high level of comfort obtained through the use of different densities of padding. The universal assembly allows installation of a variety of seats, high or low backrests, and tables. The components can create unlimited layouts, resulting in a vast number of configurations to suit any setting.

Sistema di divani su barra caratterizzato da modularità, facile assemblaggio ed estrema flessibilità, unitamente ad un elevato comfort grazie alle imbottiture a densità differenziata. La serie di agganci universali accoglie liberamente diverse tipologie di seduta, schienali alti o bassi e tavolini. Gli elementi possono essere collocati indifferentemente nelle diverse posizioni permettendo di realizzare le più svariate tipologie di layout e di adattarsi ai cambiamenti degli spazi dove è collocato.



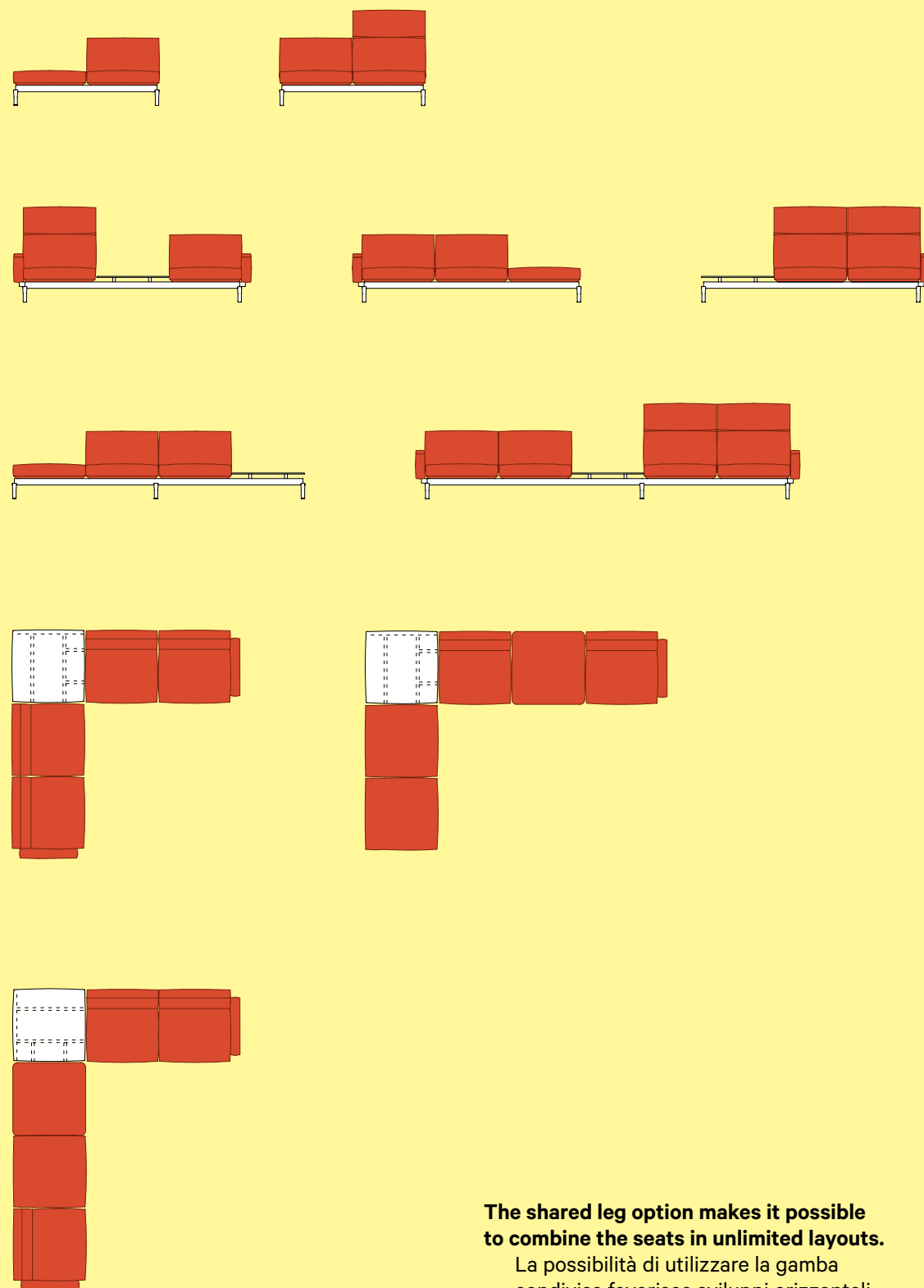

The shared leg option makes it possible to combine the seats in unlimited layouts.
 La possibilità di utilizzare la gamba condivisa favorisce sviluppi orizzontali pressoché infiniti.





Design:
Fabio Fantolino
 2019

An armchair and a compact two seat sofa with an unusual horseshoe shape that encircles and protects its occupant. The comfortable padding of the seat, in shaped, variable density polyurethane, provides outstanding comfort in all positions, thanks to the continuity between the armrests and backrest which is a characteristic of the collection. The base is formed of a robust and yet visually lightweight steel tubing frame with the soft form of the seat that seems to float above it. The versatile seat is designed for lounges and waiting rooms, in both public and private areas, and is ideally suited for contract furniture suppliers.

Poltroncina e divano a due posti dalle proporzioni contenute e dall'inusuale forma a ferro di cavallo che avvolge e protegge. La comoda imbottitura della seduta, in poliuretano sagomato a densità differenziata, assicura un elevato comfort in tutti gli appoggi, grazie alla linea continua tra schienale e braccioli che caratterizza la collezione. La base è composta da una struttura resistente, dall'impatto visivo leggero, che crea un effetto sospeso del volume morbido della scocca. La seduta versatile è progettata per soluzioni lounge e di attesa, in spazi collettivi e privati e per le esigenze delle forniture contract.



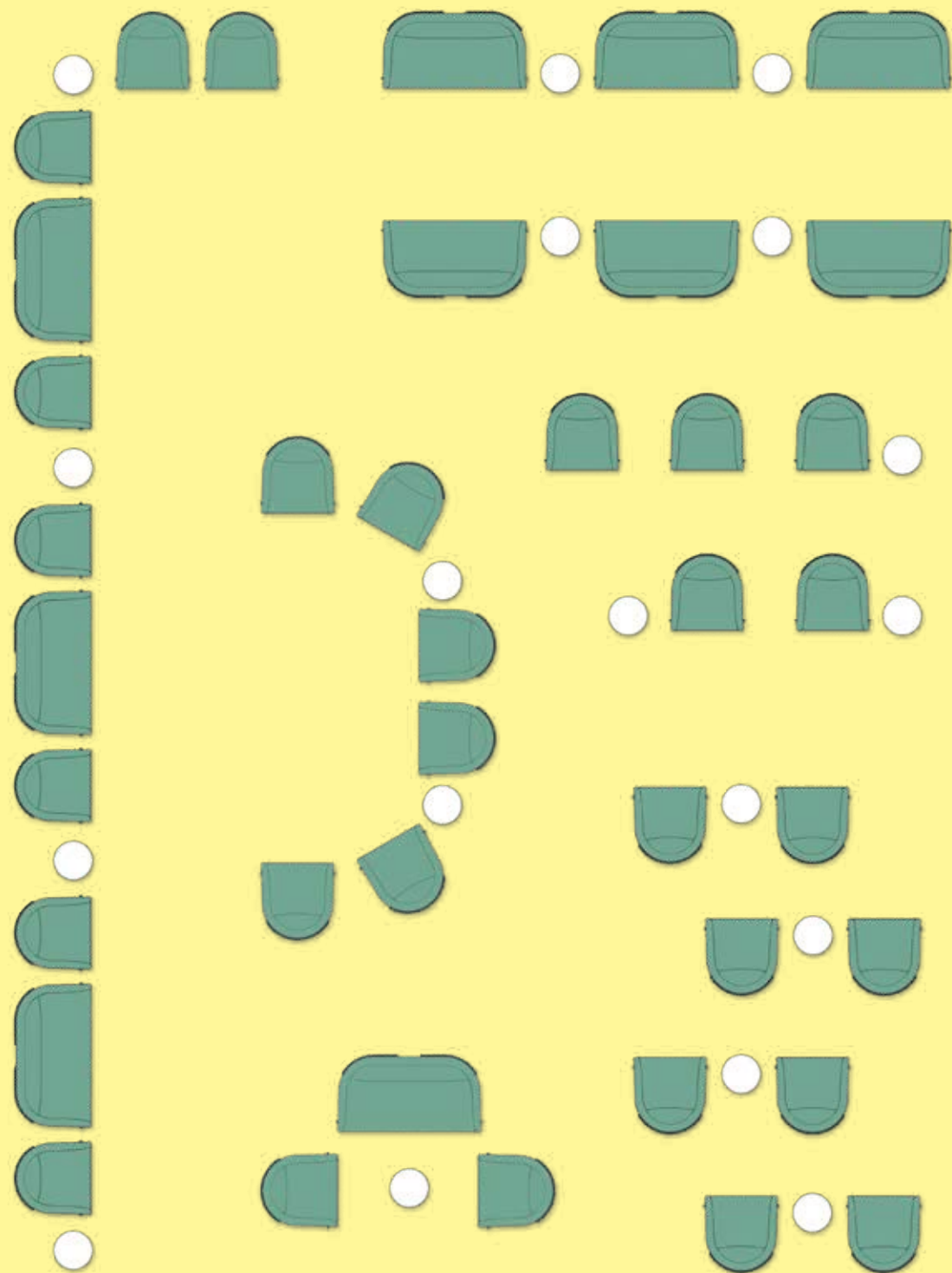



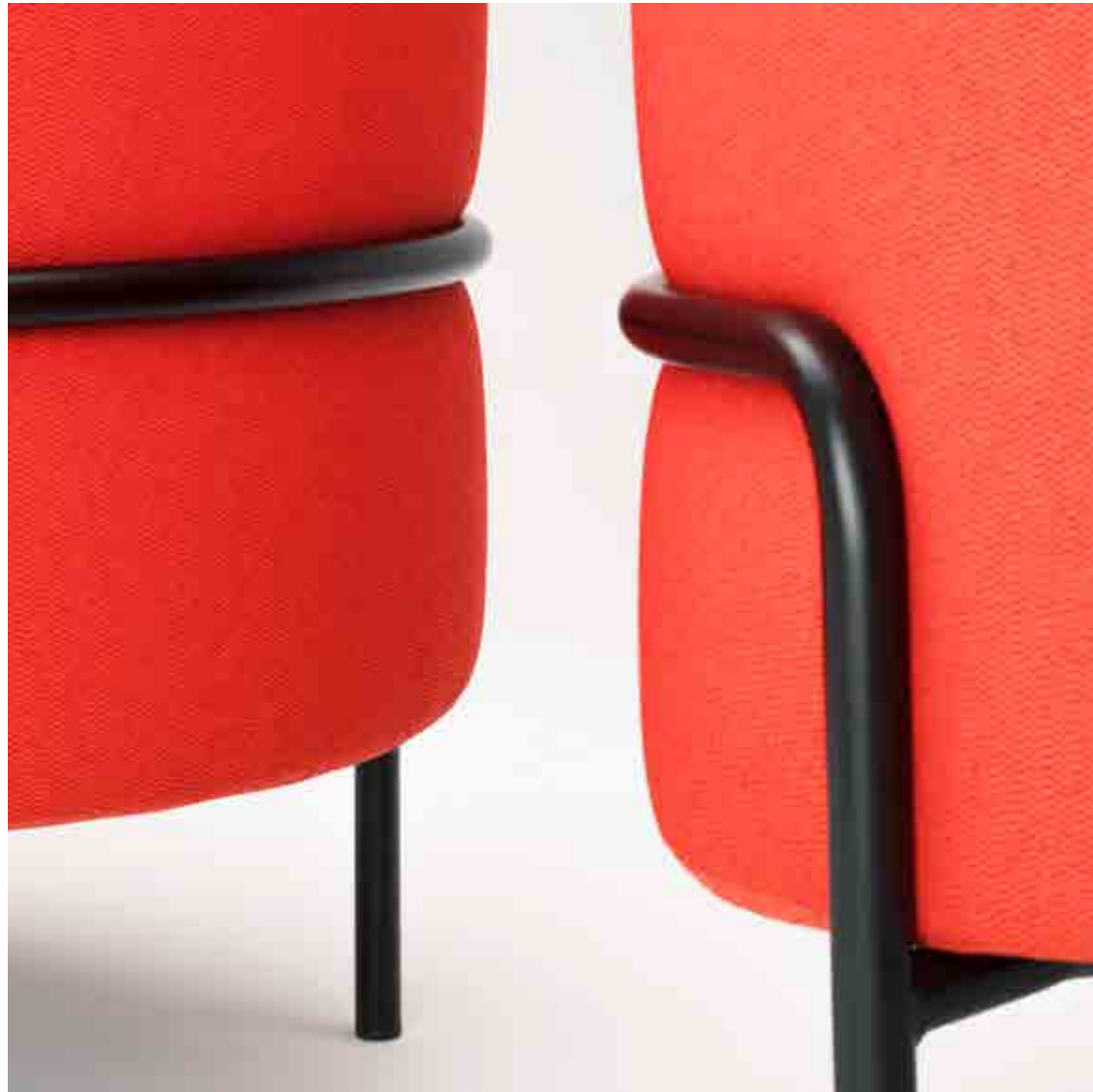

Aura

Design:
Rainlight, Centro Progetti Tecno
2018



A chair that favours thinking and meditation. In a modern-day society that is constantly connected and geared to sharing, the enveloping shape of the shell helps to create a private space: favouring a feeling of privacy and aiding concentration in co-working spaces, lounges, open-space offices and home-office environments, as well as in community and public areas.

Una seduta che favorisce il pensiero e la meditazione. In una realtà sempre connessa e orientata alla condivisione, la forma avvolgente della scocca contribuisce a creare un'area di privacy, suggerendo una sensazione di riservatezza e favorendo la concentrazione all'interno degli spazi co-working, le lounge, gli uffici open space, le situazioni home-office, così come nei luoghi collettivi e negli ambienti pubblici.





The chair welcomes its occupant with its carefully designed shape and ergonomic precision; the design expresses technical elegance and technologically advanced content in the choice of materials and production processes. The armchair, with painted die-cast aluminium base, comprises a mono-satin methacrylate monocoque shell, available in the dedicated colour palette as well as custom colours. The large cushion within the seat back, structured in zones with differentiated bearing capacity, was developed to ensure the maintenance of optimum user ergonomics, for maximum comfort.

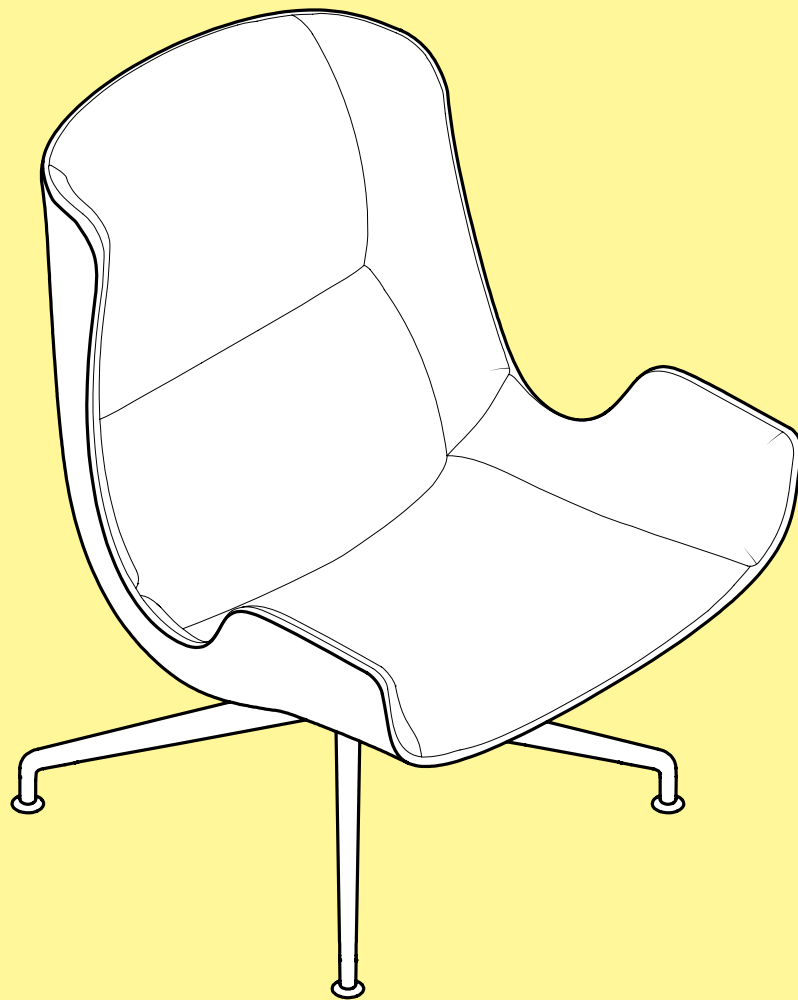

Lo studio delle forme e la precisione ergonomica rendono la seduta confortevole e accogliente; il progetto esprime l'eleganza tecnica e i contenuti tecnologicamente avanzati attraverso la scelta dei materiali e dei processi produttivi. La poltrona, con base in pressofusione di alluminio verniciato, è costituita da una monoscocca in metacrilato monosatinato, disponibile nella palette cromatica dedicata o con colore a richiesta. L'ampio cuscino interno di rivestimento, strutturato in zone a portanza differenziata, è studiato per garantire il mantenimento della corretta linea ergonomica favorendo il massimo comfort della persona.

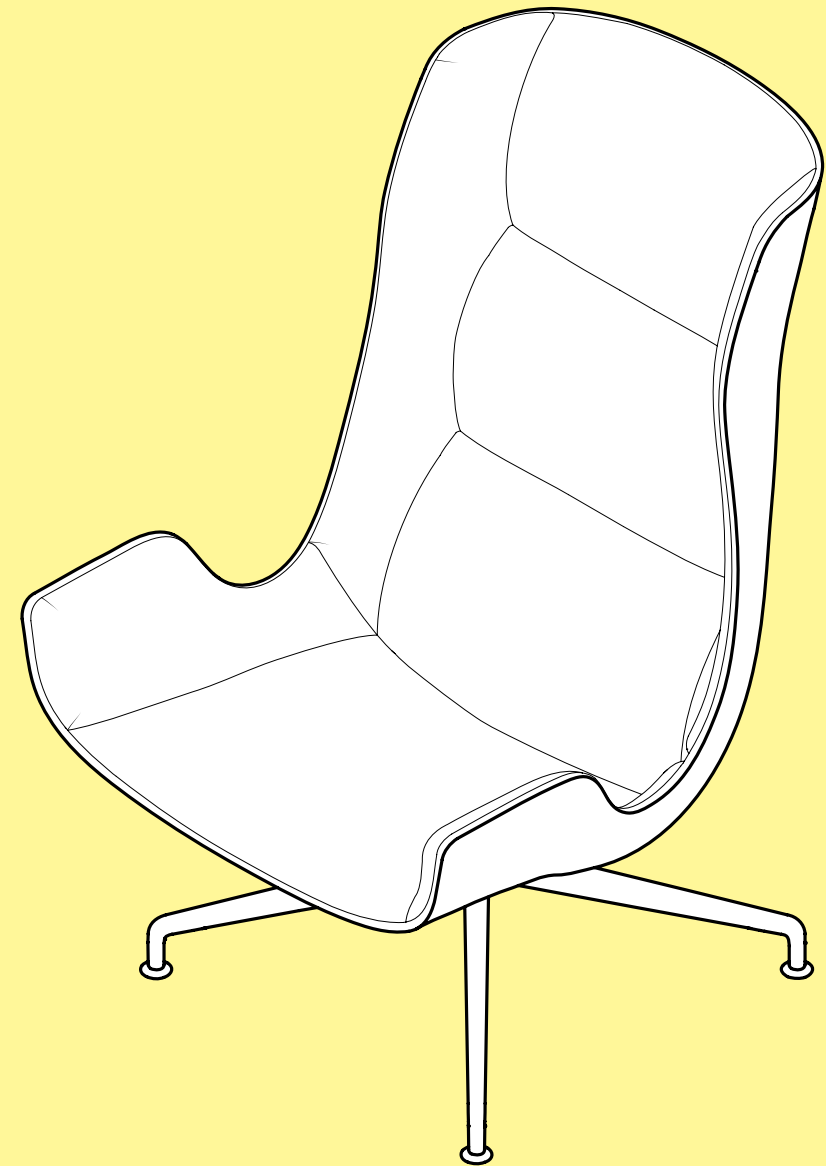



P32

Design:
Oswaldo Borsani
1956



Considered the “natural comfort centre”, the P32 armchair is not only able to swivel and return automatically to its original position, but also incorporates a backrest pivot mechanism. The freedom of the swivel movement makes it suitable for relaxation and conversation in offices, waiting rooms and lounges.

Definita come «il centro naturale della comodità», P32 è una poltrona girevole, con ritorno automatico e meccanismo basculante dello schienale. La caratteristica libertà nel movimento rotatorio la rende adatta al relax e alla conversazione per ambienti ufficio, accoglienza e lounge.







1958. Rivista dell'arredo n. 39: drawing of a studio furnished with the soft P32.

1958. Rivista dell'arredo n. 39: bozzetto di uno studio arredato con la morbida P32.

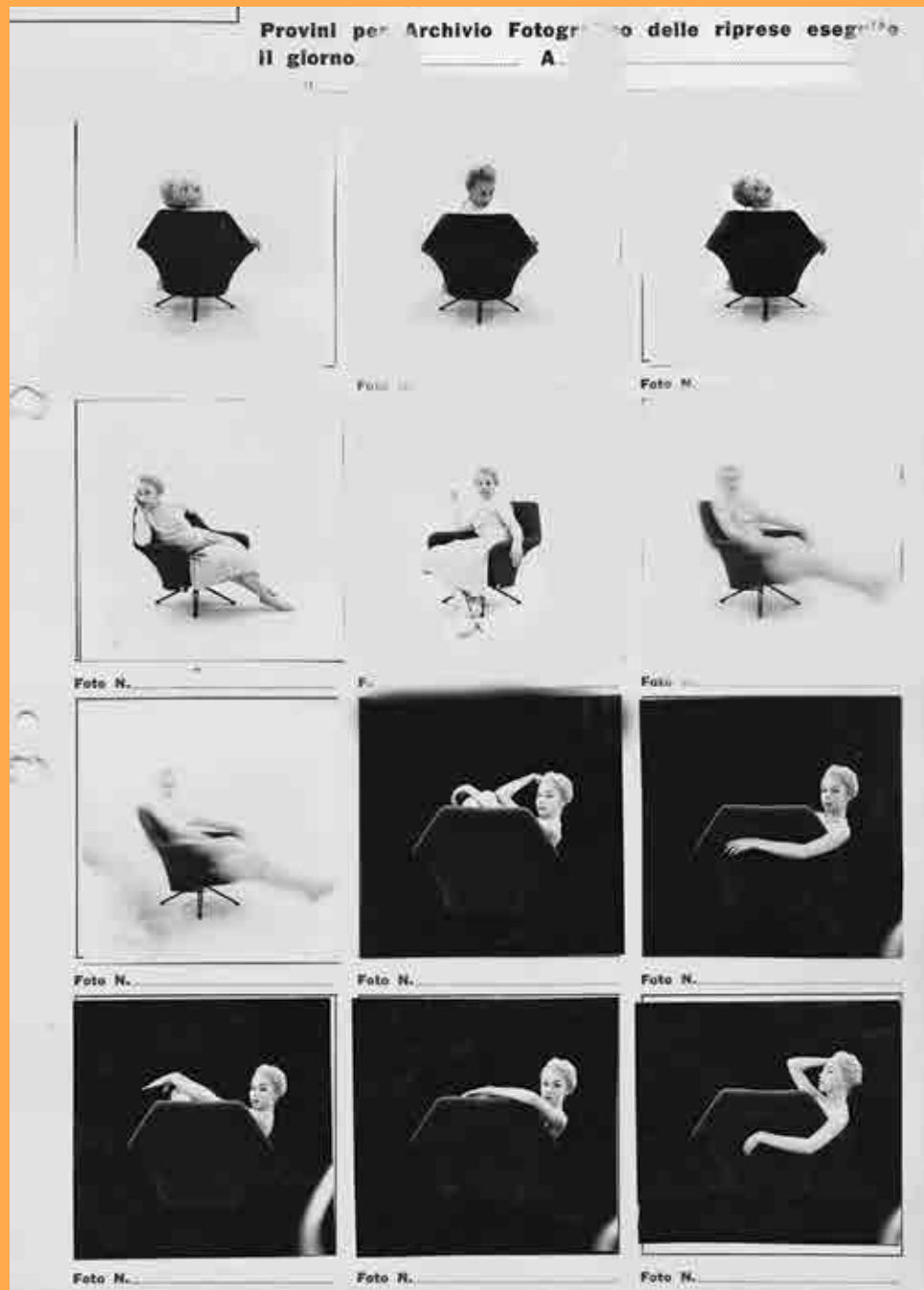

Solenoidi

Design:
Piero Lissoni
2006

Service tables with irregular tops in a variety of sizes and heights, born to complement the Asymmetrical series. White or black backpainted glass tops and metal frames painted in the matching colour. These discrete service units are ideally suited to residential settings, lounges and waiting rooms.

Tavolini con piani irregolari disponibili in diverse dimensioni e altezze, nati come ampliamento della serie Asymmetrical. Piani in cristallo retroverniciato nero o bianco e struttura in metallo verniciata nella stessa tonalità. Elementi discreti di servizio trovano collocazione in ambienti domestici, aree lounge e sale d'attesa.



T1 T2

Design:
Oswaldo Borsani
1950-1951

Lightweight, minimalist service tables, with the unmistakable design touch of Oswaldo Borsani. T1 has a chromed steel frame, characterised by a small sphere half way up and an extra-clear crystal top backpainted in a variety of colours. T2 has a dark grey glossy lacquered top supported by a steel base in matching colour and white detail.

Tavolini da servizio essenziali e leggeri, inconfondibili nel loro disegno uscito dalla mano di Oswaldo Borsani. Il T1 ha struttura in acciaio cromato, caratterizzata da una piccola sfera a mezz'asta, e piano in cristallo extra chiaro retroverniciato in diverse tonalità di colore. Il tavolino T2 ha il piano in legno laccato lucido grigio piombo su una struttura in acciaio verniciato nella stessa tonalità e con dettaglio bianco.





AT16

Design:
Oswaldo Borsani
 1961

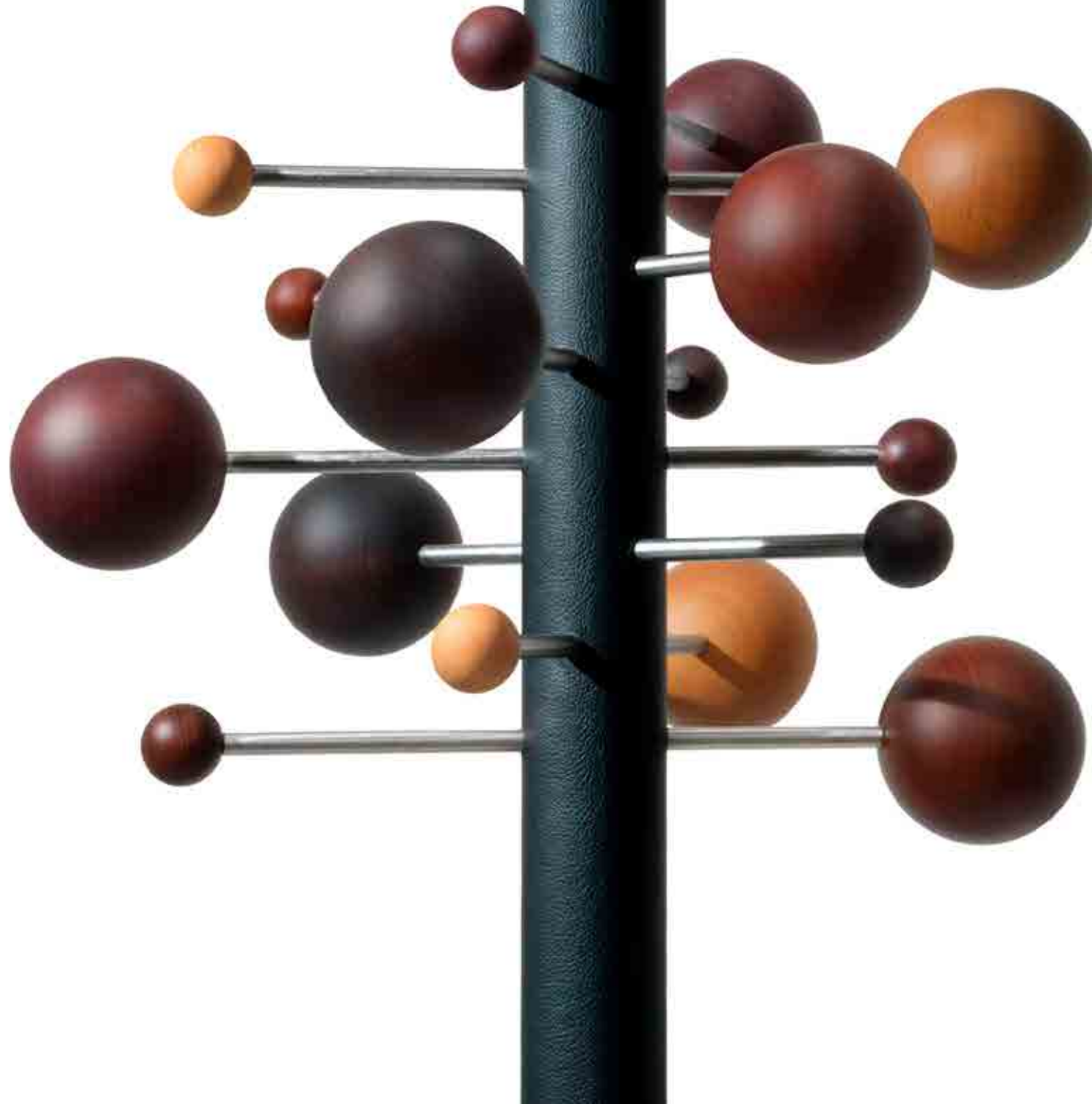

The forerunner of the column coat hanger, rotating and height-adjustable. The central column is composed of an aluminium tube covered in black leather hosting 2 concentric sliding tubes in black-anodised aluminium lockable in position by polished rings. The horizontal sticks, free to slide, end with solid beech wood spheres finished in 4 different colours.

Antesignano degli appendiabiti a colonna, girevole e regolabile in altezza. Lo stelo centrale ha una struttura composta da tubo esterno in alluminio rivestito in pelle nera e da 2 tubi concentrici scorrevoli in alluminio anodizzato nero il cui bloccaggio viene assicurato da ghiera in alluminio brillantato. Attraverso la colonna centrale avviene il passaggio dei bracci scorrevoli in acciaio inox spazzolato completati da sfere in legno massello di faggio, tinto in 4 diverse tonalità.

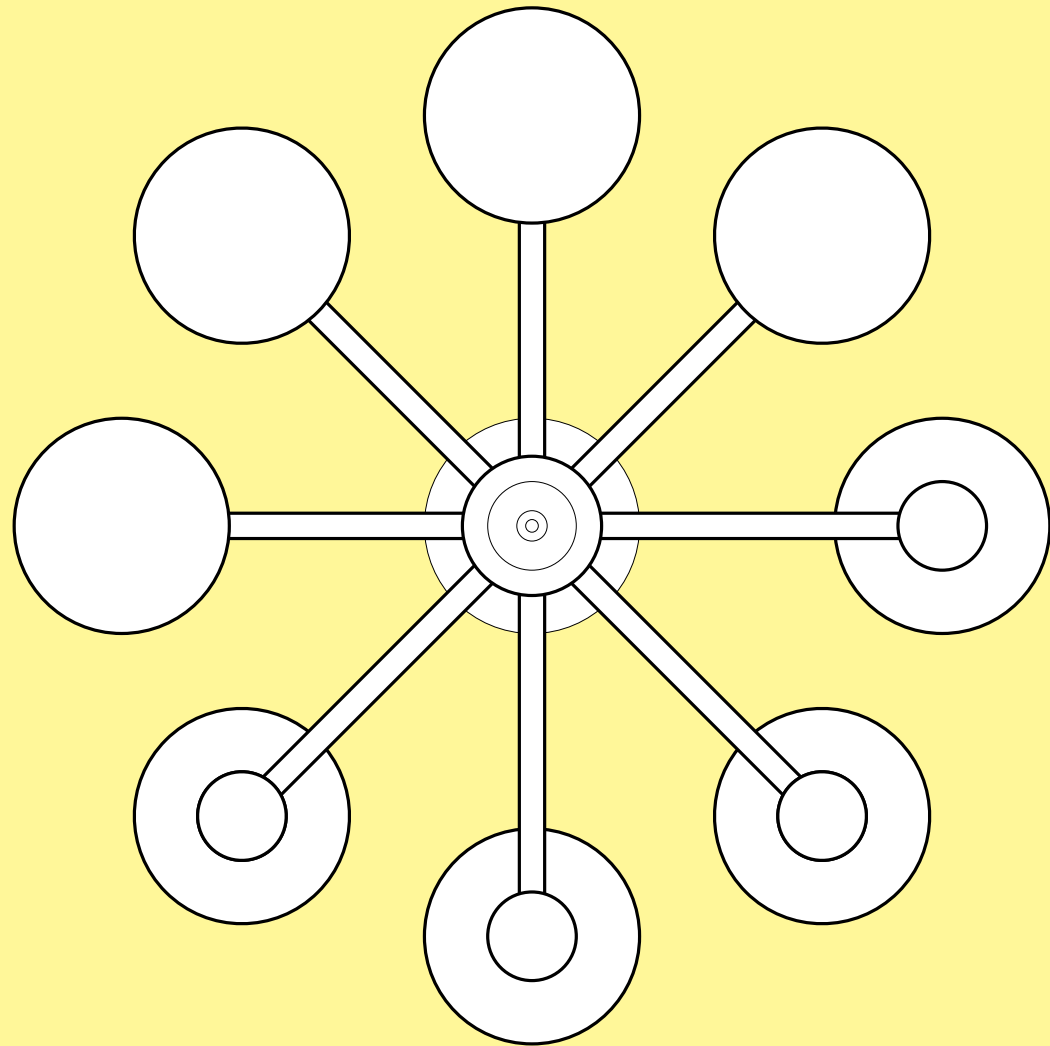

Bird's-eye view of AT16 coat hanger.
 Vista dall'alto dell'appendiabiti AT16.

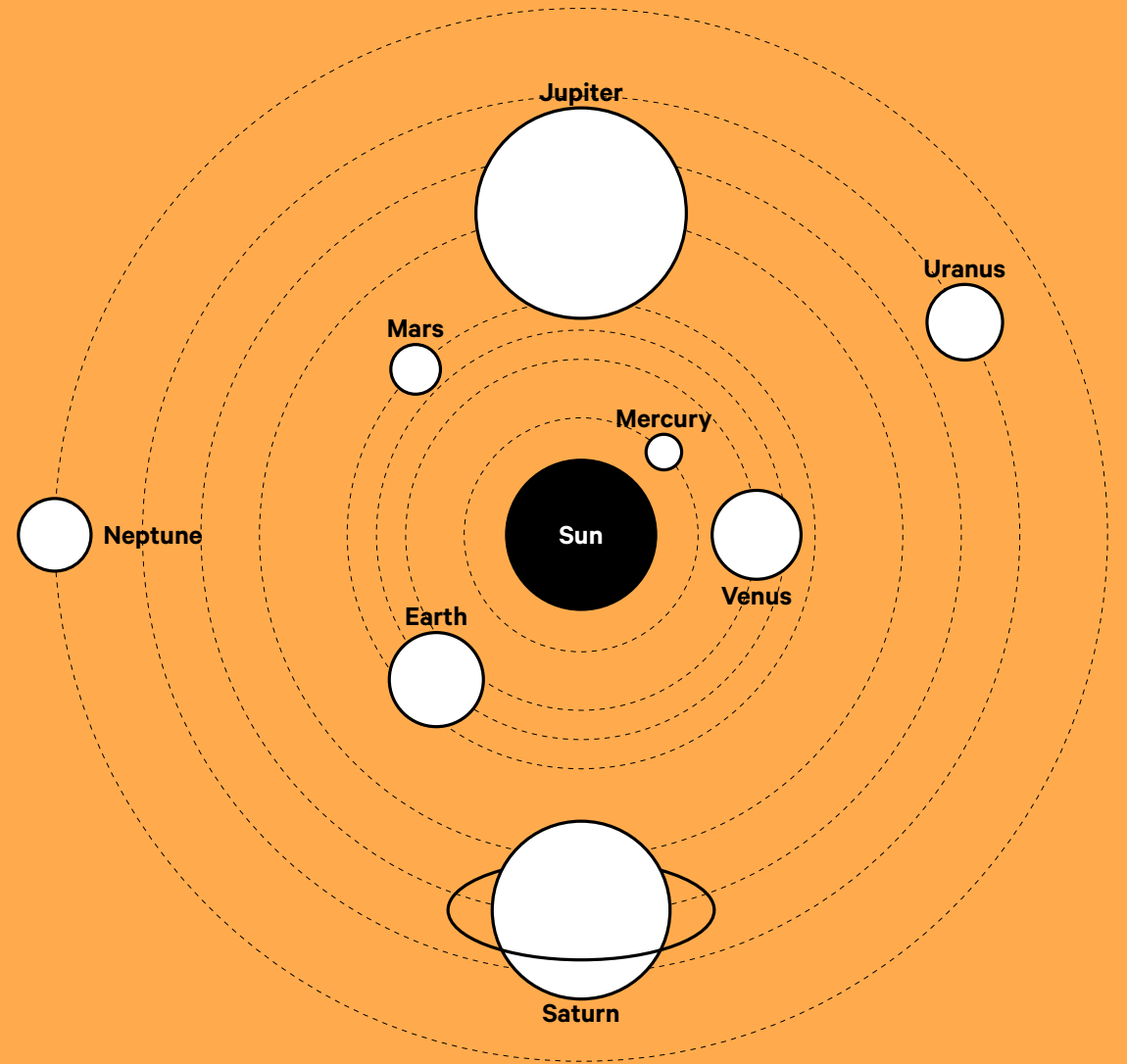



P31

Design:
Oswaldo Borsani
 1963

Reissue:
 2019



Part of ABV Collection, the iconic 3-leg chair continues to express all the Borsani-Tecno elegance of its origins, while retaining its newness to this day. The design of the chair features a formal static concept in which two thin metal tubes, jointed at the legs, open up to support the seat. The twin structure of the two tubes is repeated in the backrest. Designed with rigorous attention to detail which, even today, contributes to making it the ideal complement to any setting.

Parte della Collezione ABV, la seduta porta in evidenza il forte carattere Borsani - Tecno. P31 è un pezzo iconico che continua a esprimere eleganza progettuale del contesto storico in cui è nata e ancora attuale per il suo disegno. Definita dalla scelta formale e statica di realizzare una struttura binata composta da due sottili tubi metallici che, uniti nelle gambe, si allargano per sostenere il sedile. L'abbinamento dei due tondini viene ripreso nello schienale. La composizione, all'avanguardia per quei tempi, ancora oggi contribuisce a rendere il prodotto semplicemente innovativo e perfetto in ogni tipo di ambiente.



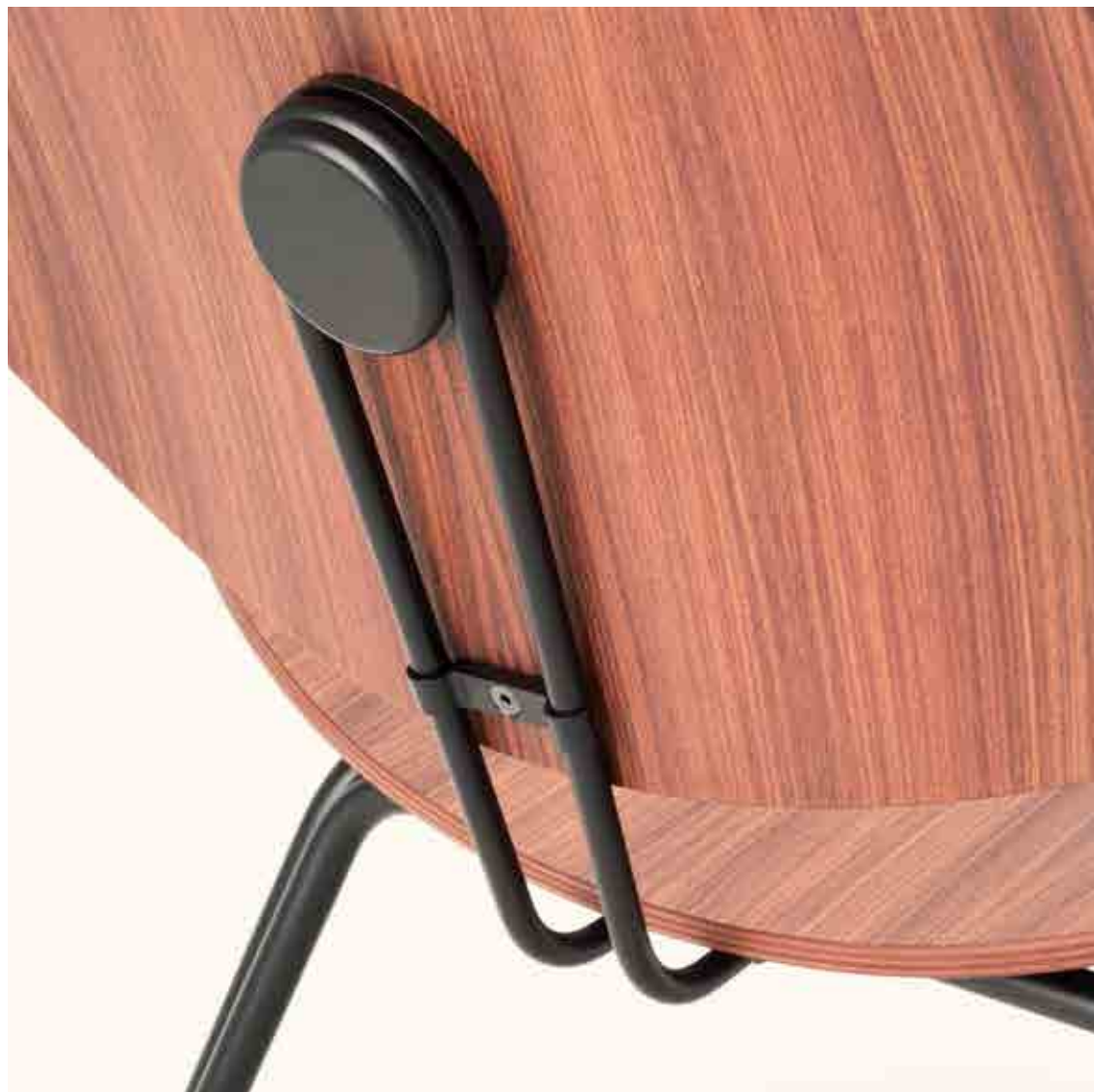

P40

Design:
Oswaldo Borsani
1955

The chaise longue par excellence: the design goes beyond the conventional fixed, bulky armchair to offer a smaller solution with a handy fan-shaped tilt system which holds the occupant securely in all positions until it closes. Completely adjustable in movement, it features a removable footrest and headrest, and flexible armrests. Orio Vergani describes it as “a quick, essential armchair, elementary like the first sum: one and one is two. It offers its curves for navigating dreams, for the delights and recuperation afforded by relaxation.”

Chaise longue per eccellenza: supera la tradizionale poltrona relax fissa e ingombrante, per creare una soluzione di dimensioni ridotte che, attraverso un agevole sistema d'inclinazione a ventaglio, accoglie il corpo in tutte le posizioni fino a chiudersi. Completamente regolabile nei movimenti, è dotata di poggiatesta e poggiapiedi estraibili e braccioli flessibili. Orio Vergani la descrisse come «una poltrona veloce, essenziale, elementare come la prima addizione: uno più uno, due. Offre la sua curva alla navigazione dei sogni, alle delizie e al ristoro del rilassamento».



D70

Design:
Oswaldo Borsani
1954

A patented sofa bed, D70 is the design manifesto for the wishes of Oswaldo Borsani: an item of furniture which is original, autonomous and elegant in form, but technical and industrial in production. The mechanism allows the sofa to be opened out until it completely reverses - an iconic design solution which allows the backrest to open to any angle, even to make a bed.

Divano-letto brevettato, è il manifesto progettuale della volontà di Oswaldo Borsani di creare un elemento d'arredo originale, autonomo ed elegante nella forma, tecnologico e industriale nella produzione. Il meccanismo che consente l'apertura totale fino alla completa reversibilità, diventato ormai una soluzione emblematica nella storia del design, rende possibile qualsiasi inclinazione dello schienale rispetto al sedile fino a farne un letto.





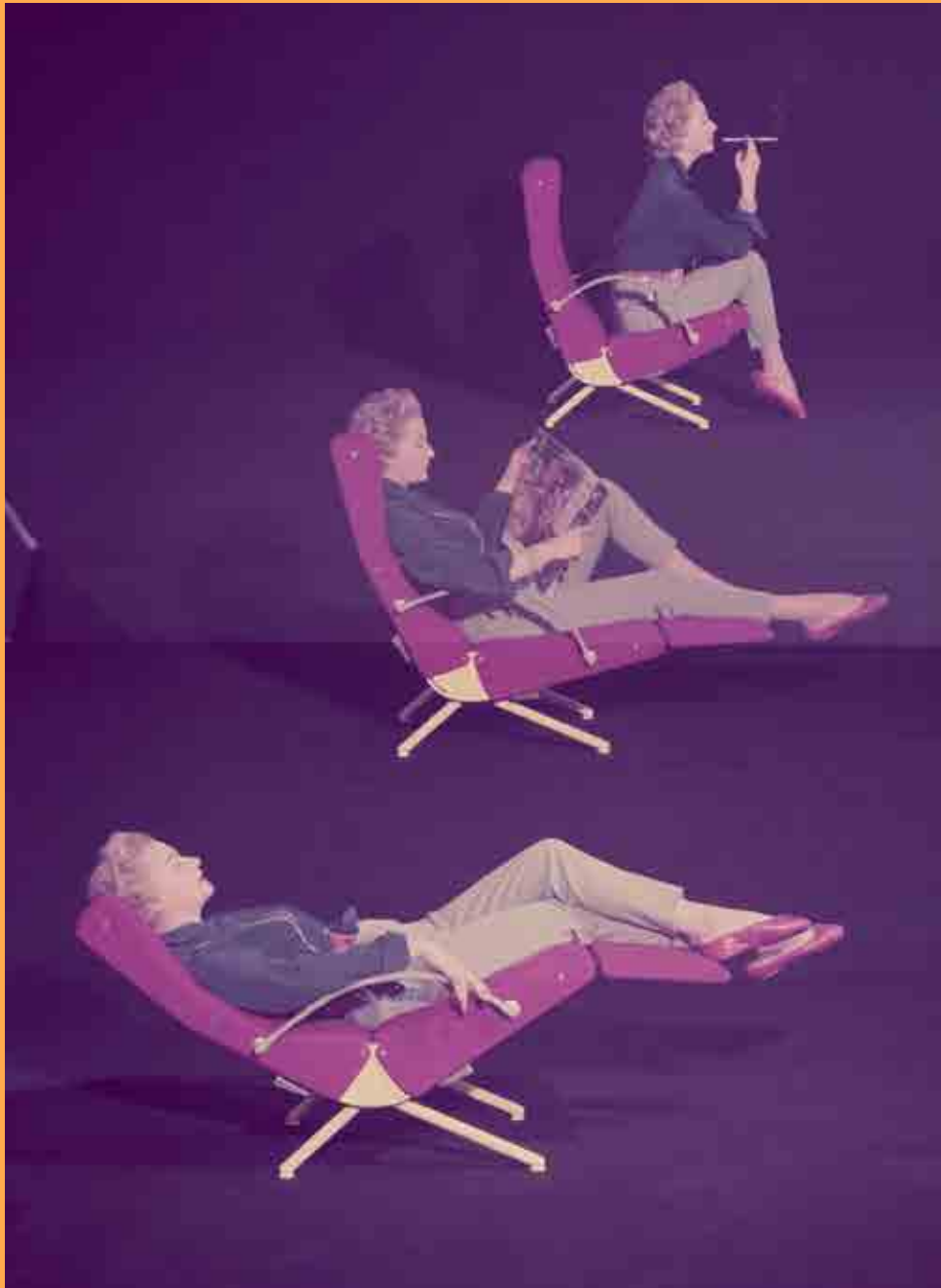

Superimposed images of a model showing three different use and positions of P40 armchair.
 Immagini sovrapposte di una modella in posa su P40, mostrandone tre diversi usi e posizioni.



Superimposed images of the D70 sofa showing the different possible positions.
 Foto sovrapposte di D70 che illustrano tutte le possibili posizioni.



The D70 mechanism.
Il meccanismo di D70.

T69

Design:
Oswaldo Borsani, Eugenio Gerli
 1963

A table with an elegant, sinuous design: the harmonic line of the body is the outcome of an extraordinarily complex technicality. The application of aluminium casting techniques, satin finished externally and matt-black painted internally, create a unique silhouette ideal for diversified settings, from residential to commercial, small meeting areas to lounges and cafeterias.

Tavolo dall'immagine elegante e flessuosa: la linea armonica del fusto è realizzata grazie ad una straordinaria complessità tecnica. L'applicazione delle tecniche fusorie dell'alluminio, l'abbinamento della finitura inox satinato sulla superficie esterna e nero opaco nella parte interna della struttura, lo rendono adatto a contesti differenziati, dagli ambienti domestici all'ambito commerciale, da piccole aree meeting a zone lounge e caffetteria.



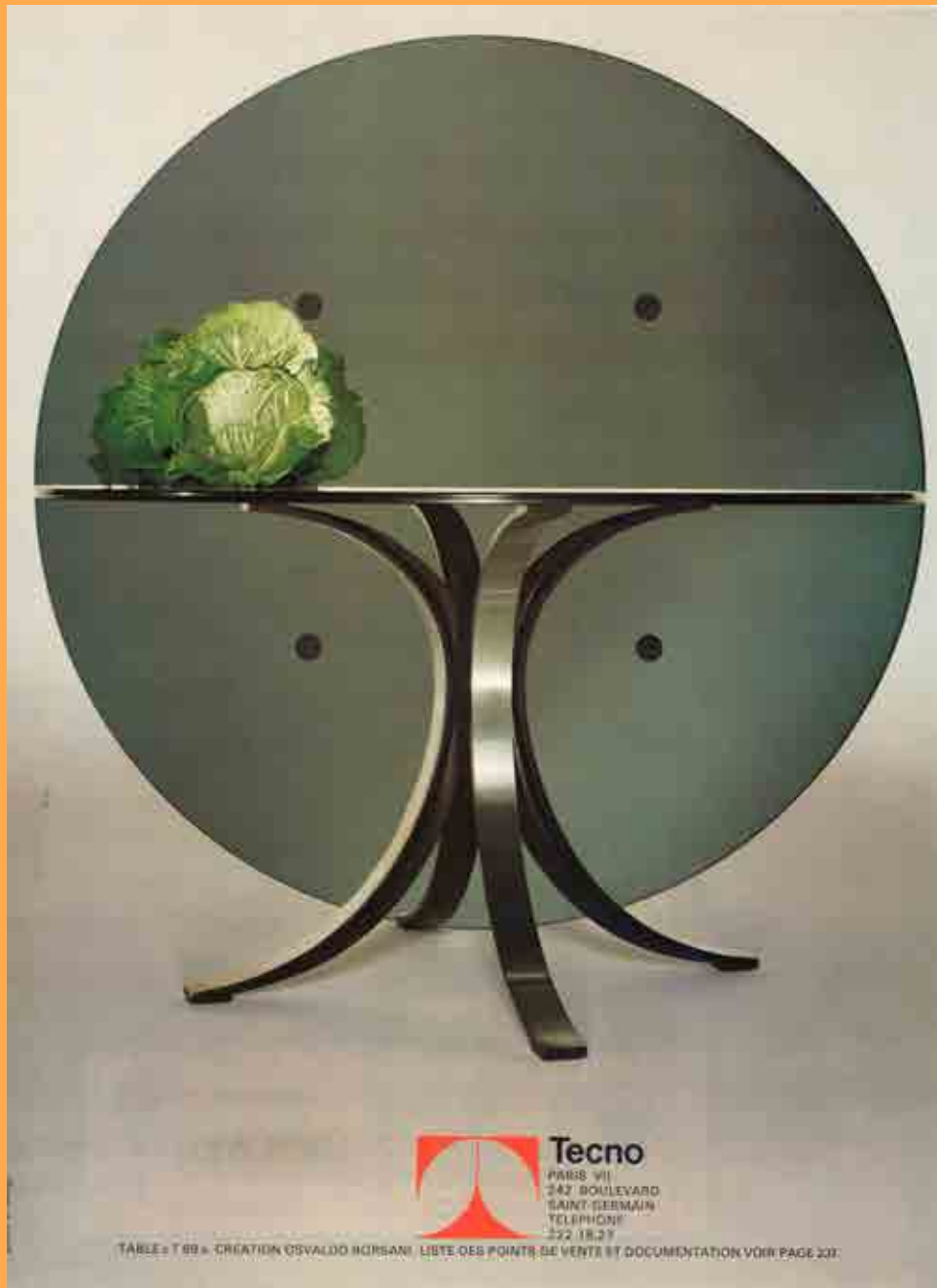

T90

Design:
Oswaldo Borsani
1954



This writing desk recalls our collective past in modern form, with its shaped, curved top in canaletto walnut supported by a slender structure in matt dark grey painted steel with adjustable feet. The 3 drawers are made from solid canaletto walnut with recessed handles. Timeless elegance which is the ideal complement for any home studio or office.

Scrittoio che rimanda alla memoria collettiva, sempre attuale nella sua forma composta da un piano sagomato e curvato in noce canaletto e da una sottile struttura portante in tubolari di acciaio verniciati grigio piombo opaco, con piedini di regolazione. I 3 cassetti sono realizzati in legno massello di noce canaletto, con maniglia incassata. Eleganza senza tempo che si inserisce perfettamente nelle zone studio home e office.

Hortus

Design:
Jean-Michel Wilmotte
2018



This minimalist bench, as a unique piece or combined in series, was born from the archetype of outdoor seating and now moves into the living spaces, characterising the new ways of furnishing.

Panca essenziale, come pezzo unico o accostata in serie, nasce dall'archetipo di seduta per esterno e si sposta oggi negli spazi interni caratterizzando i nuovi modi di arredare.

T50

Design:
Jean-Michel Wilmotte
2018

Coffee tables that are the result of a rigorous process heading towards the essence, through formal symmetry and balance. Natural materials and pure geometries create a rational composition with a sophisticated aesthetic that recalls brutalism. Legs with a seemingly rough finish and the solid wood top seem to be held together by the gravitational force of the object, without any visible joint.

Tavolini risultato di un rigoroso processo di semplificazione del disegno attraverso soluzioni formali simmetriche ed equilibrate. L'abbinamento di materiali naturali e geometrie pure crea una composizione razionale, dall'estetica sofisticata che rimanda al brutalismo. Le gambe, dalla finitura apparentemente grezza, e il piano d'appoggio in legno massiccio sembrano essere tenuti insieme dalla sola forza aggregativa dell'oggetto, senza nessun elemento di giunzione a vista.





Outlined by defined and geometric lines, warm in materials and strong in the silhouette, Hortus captures the attention. It is an invitation to a variety of settings, from waiting rooms and restaurants to coffee-break areas and even intensive work environments.

Disegnata da linee definite e geometriche, si presenta calda nei materiali e con una silhouette decisa che cattura l'attenzione. È un invito a diversi ambienti: può essere utilizzata per luoghi di sosta e ristoro, nelle aree di coffee-break o in zone di lavoro intensivo.



Extremely robust and balanced, it is the ideal product for waiting and living rooms, creating an island around which people can meet.

Estremamente robusto ed equilibrato è ideale in aree di attesa e living, creando un'isola intorno alla quale incontrarsi.



In a hyper-digitalised world, fast changing and where innovation and thinking out-of-the-box have become key values, Tecno equips workplaces where physical and digital space find new ways of dialogue, being the first to introduce the Internet of Things within office furniture.

IO.T – the Intelligence of Tecno – is the system of smart connected furnishings capable of offering information and solutions to building managers and improving end user comfort.

In un mondo iper-digitalizzato, che cambia rapidamente e dove l'innovazione e il pensare *out-of-the-box* diventano valori chiave, Tecno attrezza luoghi di lavoro in cui lo spazio fisico e quello digitale trovano nuove forme di dialogo, introducendo per prima l'internet delle cose all'interno degli arredi ufficio. IO.T – Intelligence of Tecno – è il sistema intelligente di arredi connessi capace di offrire informazioni e soluzioni ai gestori dei buildings e migliorare il comfort dell'utilizzatore finale.



Sensors incorporated into the work surface activate functions designed for the user and send information in real-time to allow resource optimisation, access control and optimised space management.

Sensori integrati nei piani di lavoro attivano funzioni al servizio dell'utente e inviano informazioni in tempo reale, permettendo l'ottimizzazione delle risorse, il controllo degli accessi e l'ottimale gestione degli spazi.



Person recognition, workstation or meeting room booking, as well as controlling the environmental systems by adjusting the lights, temperature and height of the work surface, are just some of the functions of IO.T.

Il riconoscimento personale, la prenotazione della postazione lavoro o della sala riunioni, così come la gestione del microsistema ambientale – attraverso la regolazione di luci, temperatura e altezza del piano di lavoro –, sono solo alcune delle funzioni attuabili grazie ad IO.T.

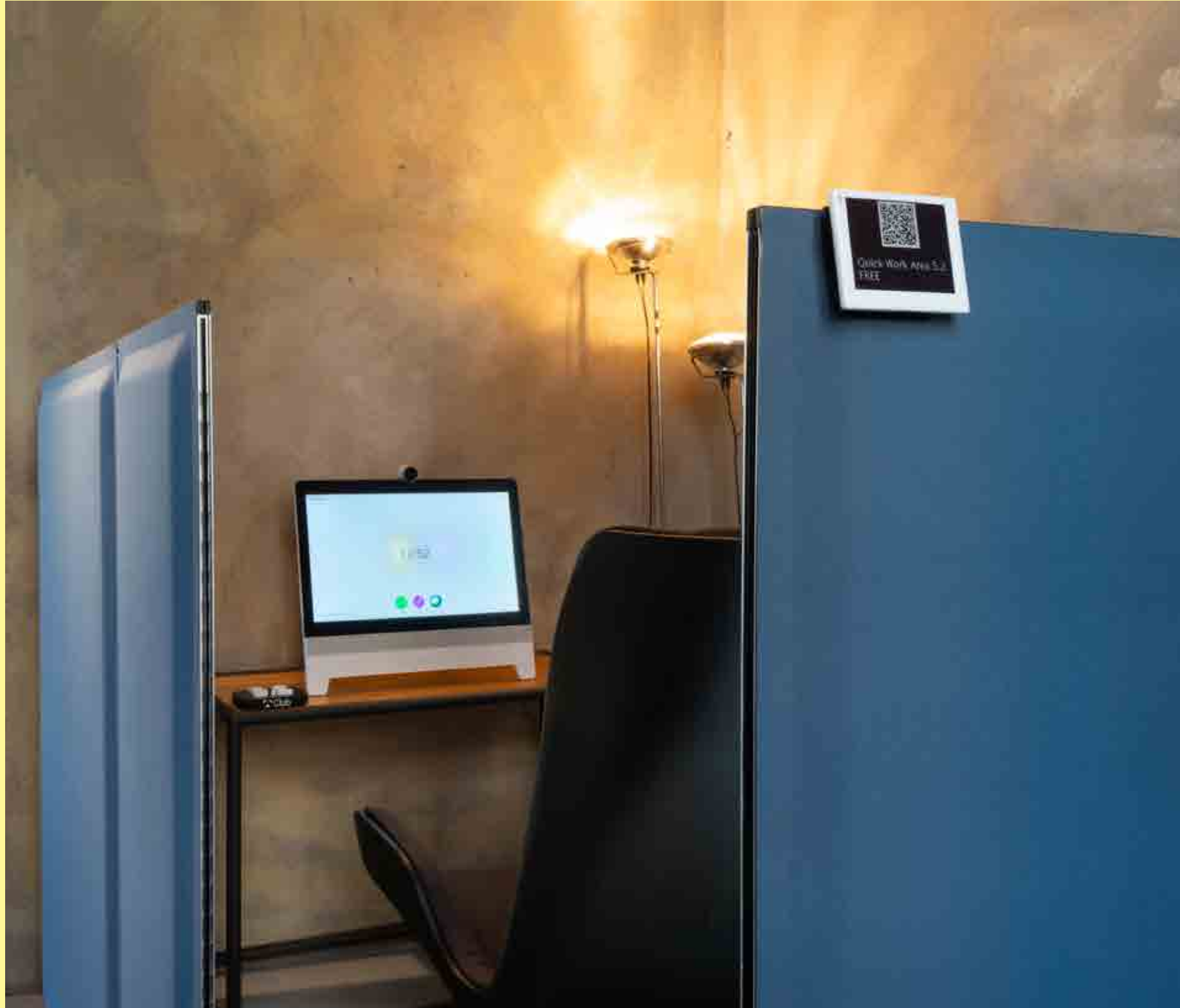

IO.T technology can be incorporated both in operative workstations as well as in meeting tables, storage areas and meeting rooms, and support various functions devised according to the customer's needs and the building organisation. Workstations, rooms and lockers can thus be connected, reserved and managed in a free, personalised manner.

La tecnologia IO.T può essere integrata sia sulle workstation operative che nei tavoli condivisi, fino ad aree storage o sale meeting così da supportare diverse funzionalità studiate in base alle esigenze del cliente e all'organizzazione del building. Postazioni, sale e lockers possono così diventare connessi, prenotabili, liberamente gestibili e customizzabili.

IO.T - The Intelligence of Tecno is powered by IO.T Solutions, a company of Tecno.

IO.T - The Intelligence of Tecno è realizzato in collaborazione con IO.T Solutions, società parte del gruppo Tecno.



iotsolutions.group



Dina – IO.T Solutions' management system – interfaces with the smart furnishings to collect and analyse information in real-time, such as workstation usage and flow data. Maintenance schedule, resource optimisation, access control and layout handling on the base of the real occupation are now possible.

Gli arredi interconnessi si interfacciano con il sistema di gestione Dina, di IO.T Solutions, che permette di raccogliere e analizzare in tempo reale i dati di flusso e utilizzo delle postazioni lavoro, consentendo di programmarne le manutenzioni, ottimizzare le risorse, controllare gli accessi e modificare i layout in base alle reali esigenze di occupazione.

Through its branches in Milan, Paris, London, New York, Ingolstadt, Seoul, Tokyo and Tunis, Tecno is leader in unique projects both aesthetically and in terms of technical characteristics. Its expertise is chosen by architects and contractors for managing works on a medium and large scale at an international level.

Tecno, attraverso le proprie sedi di Milano, Parigi, Londra, New York, Ingolstadt, Seul, Tokyo e Tunisi è leader nella realizzazione di progetti unici sia sotto il profilo estetico che per caratteristiche tecniche. La sua expertise è scelta da architetti e contractor per la gestione di cantieri di medie e grandi dimensioni a livello internazionale.

With a story that began in 1953, Tecno completes the culture of craftsmanship with industrial logic, knowledge of materials and innovation, bringing into being distinctive interior architecture and products that have become design icons, keeping its promise of quality and performance on every scale. Today, with a clear vision of the contemporary situation, Tecno implements the potential of digital and introduces smart, connected furnishings, the first to bring the internet of things to the world of the office.

Con una storia iniziata nel 1953, Tecno integra la cultura artigianale con le logiche industriali, la conoscenza dei materiali e l'innovazione dando vita ad architetture d'interni distintive e a prodotti diventati icone del design, mantenendo su ogni scala la promessa di qualità e performance. Oggi, con una lucida visione del contemporaneo, Tecno implementa le potenzialità del digitale e introduce arredi intelligenti e connessi, portando per prima l'Internet delle Cose nel mondo dell'ufficio.

Among its awards, Tecno has received five Compasso d'Oro ADI, one of which for "cultural quality expressed in product systems and in graphics".

Tra i riconoscimenti, Tecno ha ricevuto cinque Compassi d'Oro ADI, di cui uno per "la qualità culturale espressa nei sistemi di prodotto e nei segni grafici".

Just some of the special projects in which the company has been involved are the European Parliament in Brussels, Schiphol Airport in Amsterdam, the British Museum in London, the new Palais de Justice in Paris and offices such as the premises of Bulgari, Moleskine and the National Bank of Kuwait.

Interventi progettuali quali il Parlamento Europeo a Bruxelles, l'aeroporto di Schiphol ad Amsterdam, il British Museum a Londra, il nuovo Palazzo di Giustizia a Parigi e uffici come le sedi di Bulgari, Moleskine e National Bank of Kuwait, sono solo alcuni tra i progetti speciali realizzati dall'azienda.

Tecno is certified ISO 9001 and ISO 14001.

Tecno è certificata ISO 9001 e ISO 14001.

Tecno Italy

Piazza XXV Aprile 11
20154 - Milan - Italy
T +39 031 75381
E info@tecnospa.com

Tecno Headquarters

Via Milano 28, Casella Postale 121
22066 - Mariano Comense - Italy
T +39 031 75381
E info@tecnospa.com

Tecno France

Maison Atelier Ozenfant,
53 Avenue Reille, 75014 - Paris - France
T +33 1 42442630
E tecnofrance@tecnospa.com

Tecno UK

The Loom Suite 1.02, 14 Gowers Walk,
E1 8PY - London - UK
T +44 20 3829 7240
E tecnouk@tecnospa.com

Tecno USA

1201 Broadway s.te 907/908,
10001 - New York - USA
T +1 646 331 4193
E tecnousa@tecnospa.com

Tecno Germany

Sambergerstraße 18,
85053 - Ingolstadt - Germany
T +49 162 2510688
E tecnogermany@tecnospa.com

Tecno Korea

754, Samseong-ro, Gangnam-gu,
06070 Seoul, Korea
T +80 2 544 1953
E atempo.official@atempo.co.kr

Tecno Japan

1-9-7, Nishiazabu Minato-ku,
106-0031 Tokyo - Japan
T +81 3 6821 8890
E products@teamiwakiri.jp

Tecno Tunis

23 rue de Jérusalem,
1002 - Belvédère - Tunis
T +216 71 891 444
E tecno@kbr-net.com

1MP10372
08.2021

Coordinated by

Tecno Marketing & Communication dept.
marketing@tecnospa.com

Graphic design

Tassinari/Vetta
Paolo Tassinari, Fabio Furlanis, Maddalena Piana

Print

Grafiche Antiga

Collaborators

Umbrella

Photos

Angelli, Anghinelli, Germano Borrelli,
Luca Capuano, Federica Carlet, Mario Carrieri,
Pietro Carrieri, Alessandra Chemollo,
Walter Gumiero, Dela Andy Kumahor, Douglas Lee,
Andrea Martiradonna, Timothy Soar, Tatami SPRL,
Jill Tate, Max Zambelli, David Edwin Zanardi

Post-production

Azimut

Render

Bieffe Rendering

Tecno spa

Piazza XXV Aprile 11
20154 Milan – Italy

Headquarters

Via Milano 28
22066 Mariano Comense – Italy
E info@tecnospa.com
T +39 031 75381
F +39 031 7538220

tecnospa.com

**Archipelago,
Asymmetrical, AT16,
Aura, Basic, Beta,
Cento, Clavis, D70,
Détabilisation,
Graphis, Hortus,
lanus, IO.T, Laetitia,
Linea, Modus, Multy,
Nomos, P08, P31, P32,
P40, Plau, Pons, Qualis,
Serie 142, Serie 148,
Shift, Solenoidi, T1 T2,
T334 T335, T50, T69, T90,
Todo Modo, Vara, Vela.**

