

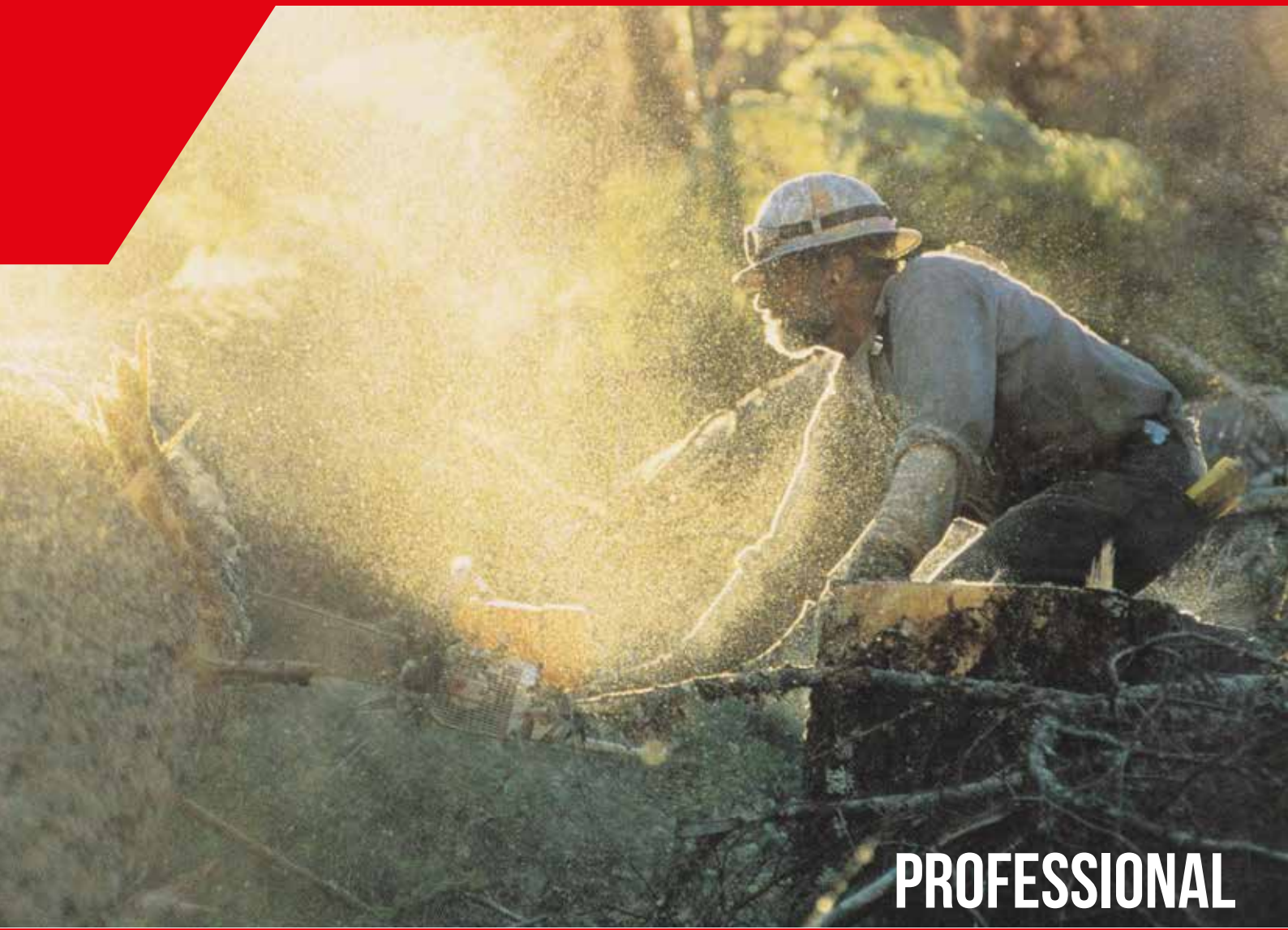

**Precision Tooling**<sup>®</sup>  
ITALY



SINCE  
1974



**PROFESSIONAL  
CHAIN SAW SPARE PARTS**



**CATALOGUE**

**25/26**



## TICK MARKS LEGEND

<b>PACKAGING: NYLON BAG</b> Containing bulk items	<b>PACKAGING: CLAMSHELL</b> Containing bulk items	<b>PACKAGING: CARDBOARD</b> Containing bulk items	<b>PACKAGING: CARTON BOX</b> Containing bulk items	<b>PACKAGING: CARTON BOX</b> containing bar chainsaw	<b>PACKAGING: CARTON BOX</b> contains 1 liter oil	<b>PACKAGING: CARTON BOX</b> contains 5 liter oil	
<b>MASTER PACK: CARTON BOX</b> Containing single nylon bags	<b>MASTER PACK: CARTON BOX</b> Containing single clamshells	<b>MASTER PACK: CARTON BOX</b> Containing single boxes	<b>MASTER PACK: CARTON PALLET</b> Containing bulk items	<b>MAX QUANTITY PER PALLET</b>	<b>MASTER PACK: CARTON PALLET</b> Containing single bottles	<b>MASTER PACK: CARTON PALLET</b> Containing single tanks	

CYLINDER - PISTON	4-13	INSULATED CABLE	34
PISTON RING	14	STATOR ASSY	34
CRANKSHAFT ASSY	15-16	SPARK PLUG	34
NUT	16	SPARK PLUG TERMINAL + SPRING	34
GASKET SETS KIT	16	IGNITION COIL	35
CRANKCASE ASSY W/BEARING	17	POINT SET	35
		CONDENSER	35
HANDLE SHROUD ASSY	18	CHAIN SAW GUIDE BAR	36
CARBURETTOR COVER ASSY	18	HEAVY DUTY CHAIN SAW GUIDE BAR	36
CHAIN/SPROCKET COVER	18	SAW CHAIN IN REEL - 100 FEET	37
FAN COVER ASSY	18	SAW CHAIN IN LOOP	37
OIL FILLER CAP	19	SPUR SPROCKET	39
CHAIN TIGHTENER	19	SPROCKET + RIM	39
FUEL CAP	19	RIM SPROCKET	39
OIL CAP	19		
TUBE HANDLE	20	TORX KEY	40
GRIP	20	COMBINATION WRENCH	40-41
PAWL	20		
STARTER ROPE	20		
REWIND SPRING	21		
STARTER PULLEY	21		
AIR FILTER	22		
FUEL FILTER	23		
OIL PUMP ASSY	24-26		
OIL PUMP DIAPHRAGM	24		
WORM GEAR	24-26		
WORM + GEAR KIT	25		
WORM + SPRING KIT	26		
CARBURETTOR	27-29		
RUBBER FUEL LINE	30		
2 STROKE OIL	30		
EXHAUST	31		
CLUTCH ASSY	32-33		
CLUTCH CARRIER - A	32		
CLUTCH SPRING	32		
FLYWHEEL	33		



## PROFESSIONAL CHAIN SAW SPARE PARTS

CYLINDER & PISTON – PISTONRING

CYLINDER & PISTON – PISTONRING



## CYLINDER ASSY

SUITABLE FOR THE FOLLOWING CHAIN SAWS

MAKE FITS	<b>STIHL 070</b>
DESCRIPTION	Cylinder assy ø 58 mm
P/N	<b>88570180P</b>
O.E.M. REF	1106 020 1202

PACKAGING:	<b>SINGLE BOX</b>
Q.TY x MASTER PACK:	27 pcs
DIM. MASTER CARTON:	41 x 41 x 42 h cm
TOTAL WEIGHT:	40,5 kg
ORDER MULTIPLES OF:	<b>27 pcs</b>

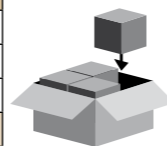

## CYLINDER ASSY

SUITABLE FOR THE FOLLOWING CHAIN SAWS

MAKE FITS	<b>STIHL MS381</b>
DESCRIPTION	Cylinder assy ø 52 mm Decompression Valve Included
P/N	<b>88570002</b>
O.E.M. REF	1119 020 1204

PACKAGING:	<b>SINGLE BOX</b>
Q.TY x MASTER PACK:	27 pcs
DIM. MASTER CARTON:	36 x 33 x 35 h cm
TOTAL WEIGHT:	21,5 kg
ORDER MULTIPLES OF:	<b>1 pcs</b>

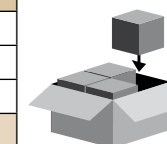

## PISTON ASSY

SUITABLE FOR THE FOLLOWING CHAIN SAWS

MAKE FITS	<b>STIHL 070</b>
DESCRIPTION	Piston assy
P/N	<b>88572188</b>
O.E.M. REF	1106 030 2003

PACKAGING:	<b>SINGLE BOX</b>
Q.TY x MASTER PACK:	150
DIM. MASTER CARTON:	41 x 41 x 42 h cm
TOTAL WEIGHT:	35 kg
ORDER MULTIPLES OF:	<b>150 pcs</b>

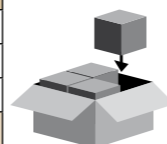

## DECOMPRESSION VALVE KIT

SUITABLE FOR THE FOLLOWING CHAIN SAWS

MAKE FITS	<b>STIHL MS381</b>
P/N	<b>576901</b>
PACKAGING:	<b>NYLON BAG</b>
ORDER MULTIPLES OF:	<b>1 pcs</b>



## PISTON ASSY

SUITABLE FOR THE FOLLOWING CHAIN SAWS

MAKE FITS	<b>STIHL MS381</b>
DESCRIPTION	Piston assy
P/N	<b>88572515</b>
O.E.M. REF	1119 030 2003

PACKAGING:	<b>SINGLE BOX</b>
Q.TY x MASTER PACK:	150 pcs
DIM. MASTER CARTON:	42 x 42 x h 42 cm
TOTAL WEIGHT:	21,5 kg
ORDER MULTIPLES OF:	<b>1 pcs</b>

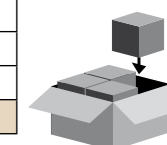

## PISTON RING SET

SUITABLE FOR THE FOLLOWING CHAIN SAWS

MAKE FITS	<b>STIHL 070</b>
DESCRIPTION	Piston ring 58x1,5 mm
P/N	<b>88574603</b>
O.E.M. REF	1106 034 3003

PACKAGING:	<b>CLAMSHELL 2 pcs</b>
Q.TY x MASTER PACK:	1200 pcs
DIM. MASTER CARTON:	41 x 41 x 42 h cm
TOTAL WEIGHT:	25 kg
ORDER MULTIPLES OF:	<b>100 pcs</b>



## PISTON RING SET

SUITABLE FOR THE FOLLOWING CHAIN SAWS

MAKE FITS	<b>STIHL MS381</b>
DESCRIPTION	Piston ring ø 52 mm
P/N	<b>88574106</b>
O.E.M. REF	1115 034 3010

PACKAGING:	<b>CLAMSHELL 2 pcs</b>
Q.TY x MASTER PACK:	1200 pcs
DIM. MASTER CARTON:	41 x 41 x 42 h cm
TOTAL WEIGHT:	25 kg
ORDER MULTIPLES OF:	<b>100 pcs</b>

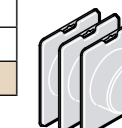

## CYLINDER ASSY

SUITABLE FOR THE FOLLOWING CHAIN SAWS

MAKE FITS	<b>STIHL 038 MAGNUM</b>
DESCRIPTION	Cylinder assy ø 52 mm
P/N	<b>88570272</b>
O.E.M. REF	1119 020 1202

PACKAGING:	<b>SINGLE BOX</b>
Q.TY x MASTER PACK:	27 pcs
DIM. MASTER CARTON:	36 x 33 x 35 h cm
TOTAL WEIGHT:	21,5 kg
ORDER MULTIPLES OF:	<b>1 pcs</b>

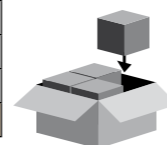

## CYLINDER ASSY

SUITABLE FOR THE FOLLOWING CHAIN SAWS

MAKE FITS	<b>STIHL MS382</b>
DESCRIPTION	Cylinder assy ø 52 mm
P/N	<b>88570114</b>
O.E.M. REF	1119 020 1208

PACKAGING:	<b>SINGLE BOX</b>
Q.TY x MASTER PACK:	27 pcs
DIM. MASTER CARTON:	36 x 33 x 35 h cm
TOTAL WEIGHT:	21,5 kg
ORDER MULTIPLES OF:	<b>1 pcs</b>

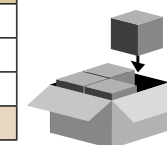

## PISTON ASSY

SUITABLE FOR THE FOLLOWING CHAIN SAWS

MAKE FITS	<b>STIHL 038 MAGNUM</b>
DESCRIPTION	Piston assy
P/N	<b>88572515</b>
O.E.M. REF	1119 030 2002

PACKAGING:	<b>SINGLE BOX</b>
Q.TY x MASTER PACK:	150 pcs
DIM. MASTER CARTON:	42 x 42 x 42 h cm
TOTAL WEIGHT:	21,5 kg
ORDER MULTIPLES OF:	<b>1 pcs</b>

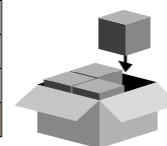

## PISTON ASSY

SUITABLE FOR THE FOLLOWING CHAIN SAWS

MAKE FITS	<b>STIHL MS382</b>
DESCRIPTION	Piston assy
P/N	<b>88572008</b>
O.E.M. REF	1119 030 2005

PACKAGING:	<b>SINGLE BOX</b>
Q.TY x MASTER PACK:	150 pcs
DIM. MASTER CARTON:	42 x 42 x 42 h cm
TOTAL WEIGHT:	21,5kg
ORDER MULTIPLES OF:	<b>1 pcs</b>

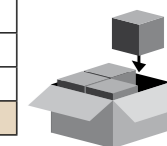

## PISTON RING SET

SUITABLE FOR THE FOLLOWING CHAIN SAWS

MAKE FITS	<b>STIHL 038 MAGNUM</b>
DESCRIPTION	Piston ring ø 52 mm
P/N	<b>88574106</b>
O.E.M. REF	1115 034 3010

PACKAGING:	<b>CLAMSHELL 2 pcs</b>
Q.TY x MASTER PACK:	1200 pcs
DIM. MASTER CARTON:	41 x 41 x 42 h cm
TOTAL WEIGHT:	25 kg
ORDER MULTIPLES OF:	<b>100 pcs</b>



## PISTON RING SET

SUITABLE FOR THE FOLLOWING CHAIN SAWS

MAKE FITS	<b>STIHL MS382</b>
DESCRIPTION	Piston ring ø 52 mm
P/N	<b>88574006</b>
O.E.M. REF	1122 034 3000

PACKAGING:	<b>CLAMSHELL 2 pcs</b>
Q.TY x MASTER PACK:	1200 pcs
DIM. MASTER CARTON:	41 x 41 x 42 h cm
TOTAL WEIGHT:	25 kg
ORDER MULTIPLES OF:	<b>100 pcs</b>



## NEW CYLINDER ASSY

SUITABLE FOR THE FOLLOWING CHAIN SAWS

MAKE FITS	<b>STIHL MS382</b>
DESCRIPTION	<b>Cylinder assy ø 52 mm</b>
P/N	<b>88570114P</b>
O.E.M. REF	1119 020 1200

PACKAGING:	<b>SINGLE BOX</b>
Q.TY x MASTER PACK:	27 pcs
DIM. MASTER CARTON:	36 x 33 x 35 h cm
TOTAL WEIGHT:	21,5 kg
ORDER MULTIPLES OF:	<b>1 pcs</b>

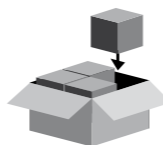

## CYLINDER ASSY

SUITABLE FOR THE FOLLOWING CHAIN SAWS

MAKE FITS	<b>STIHL MS660</b>
DESCRIPTION	<b>Cylinder assy ø 54 mm</b>
P/N	<b>88570009</b>
O.E.M. REF	1122 020 1211

PACKAGING:	<b>SINGLE BOX</b>
Q.TY x MASTER PACK:	27 pcs
DIM. MASTER CARTON:	36 x 33 x 35 h cm
TOTAL WEIGHT:	21,5 kg
ORDER MULTIPLES OF:	<b>1 pcs</b>

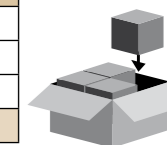

## PISTON ASSY

SUITABLE FOR THE FOLLOWING CHAIN SAWS

MAKE FITS	<b>STIHL MS382</b>
DESCRIPTION	<b>Piston assy</b>
P/N	<b>88572008</b>
O.E.M. REF	1119 030 2005

PACKAGING:	<b>SINGLE BOX</b>
Q.TY x MASTER PACK:	150 pcs
DIM. MASTER CARTON:	42 x 42 x 42 h cm
TOTAL WEIGHT:	21,5kg
ORDER MULTIPLES OF:	<b>1 pcs</b>

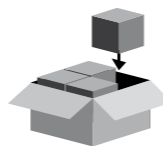

## PISTON ASSY

SUITABLE FOR THE FOLLOWING CHAIN SAWS

MAKE FITS	<b>STIHL MS660</b>
DESCRIPTION	<b>Piston assy</b>
P/N	<b>88572004</b>
O.E.M. REF	1122 030 2005

PACKAGING:	<b>SINGLE BOX</b>
Q.TY x MASTER PACK:	150 pcs
DIM. MASTER CARTON:	42 x 42 x 42 h cm
TOTAL WEIGHT:	21,5kg
ORDER MULTIPLES OF:	<b>1 pcs</b>

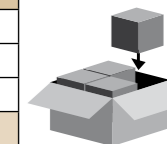

## PISTON RING SET

SUITABLE FOR THE FOLLOWING CHAIN SAWS

MAKE FITS	<b>STIHL MS382</b>
DESCRIPTION	<b>Piston ring ø 52 mm</b>
P/N	<b>88574006</b>
O.E.M. REF	1122 034 3000

PACKAGING:	<b>CLAMSHELL 2 pcs</b>
Q.TY x MASTER PACK:	1200 pcs
DIM. MASTER CARTON:	41 x 41 x 42 h cm
TOTAL WEIGHT:	25 kg
ORDER MULTIPLES OF:	<b>100 pcs</b>



## PISTON RING SET

SUITABLE FOR THE FOLLOWING CHAIN SAWS

MAKE FITS	<b>STIHL MS660</b>
DESCRIPTION	<b>Piston ring ø 54 mm</b>
P/N	<b>88574002</b>
O.E.M. REF	1122 034 3001

PACKAGING:	<b>CLAMSHELL 2 pcs</b>
Q.TY x MASTER PACK:	1200 pcs
DIM. MASTER CARTON:	41 x 41 x 42 h cm
TOTAL WEIGHT:	25 kg
ORDER MULTIPLES OF:	<b>100 pcs</b>

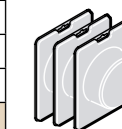

CYLINDER & PISTON - PISTONRING

CYLINDER & PISTON - PISTONRING

## NEW CYLINDER ASSY

SUITABLE FOR THE FOLLOWING CHAIN SAWS

MAKE FITS	<b>STIHL MS651</b>
DESCRIPTION	<b>Cylinder assy ø 56 mm</b>
P/N	<b>88570116</b>
O.E.M. REF	1144 020 1201

PACKAGING:	<b>SINGLE BOX</b>
Q.TY x MASTER PACK:	27 pcs
DIM. MASTER CARTON:	36 x 33 x 35 h cm
TOTAL WEIGHT:	21,5 kg
ORDER MULTIPLES OF:	<b>1 pcs</b>

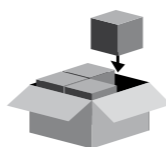

## CYLINDER ASSY

SUITABLE FOR THE FOLLOWING CHAIN SAWS

MAKE FITS	<b>HUSQVARNA 268-268S-268K</b>
DESCRIPTION	<b>Cylinder assy ø 50 mm</b>
P/N	<b>88570280</b>
O.E.M. REF	503 61 10-71

PACKAGING:	<b>SINGLE BOX</b>
Q.TY x MASTER PACK:	27 pcs
DIM. MASTER CARTON:	36 x 33 x 35 h cm
TOTAL WEIGHT:	21,5 kg
ORDER MULTIPLES OF:	<b>1 pcs</b>

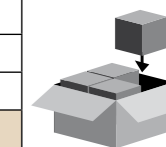

## NEW PISTON ASSY

SUITABLE FOR THE FOLLOWING CHAIN SAWS

MAKE FITS	<b>STIHL MS651</b>
DESCRIPTION	<b>Piston assy ø 56 mm</b>
P/N	<b>88572010</b>
O.E.M. REF	1144 030 2001

PACKAGING:	<b>SINGLE BOX</b>
Q.TY x MASTER PACK:	150 pcs
DIM. MASTER CARTON:	42 x 42 x 42 h cm
TOTAL WEIGHT:	21,5kg
ORDER MULTIPLES OF:	<b>1 pcs</b>

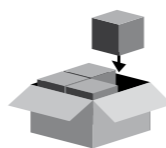

## PISTON ASSY

SUITABLE FOR THE FOLLOWING CHAIN SAWS

MAKE FITS	<b>HUSQVARNA 268-268S-268K</b>
DESCRIPTION	<b>Piston assy</b>
P/N	<b>88572524</b>
O.E.M. REF	503 44 83-71

PACKAGING:	<b>SINGLE BOX</b>
Q.TY x MASTER PACK:	150 pcs
DIM. MASTER CARTON:	42 x 42 x 42 h cm
TOTAL WEIGHT:	21,5kg
ORDER MULTIPLES OF:	<b>1 pcs</b>

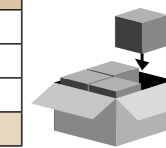

## NEW PISTON RING SET

SUITABLE FOR THE FOLLOWING CHAIN SAWS

MAKE FITS	<b>STIHL MS651</b>
DESCRIPTION	<b>Piston ring ø 56 mm</b>
P/N	<b>88574008</b>
O.E.M. REF	1144 034 3000

PACKAGING:	<b>CLAMSHELL 2 pcs</b>
Q.TY x MASTER PACK:	1200 pcs
DIM. MASTER CARTON:	41 x 41 x 42 h cm
TOTAL WEIGHT:	25 kg
ORDER MULTIPLES OF:	<b>100 pcs</b>



## PISTON RING SET

SUITABLE FOR THE FOLLOWING CHAIN SAWS

MAKE FITS	<b>HUSQVARNA 268-268S-268K</b>
DESCRIPTION	<b>Piston ring ø 50 mm</b>
P/N	<b>88574142</b>
O.E.M. REF	503 28 90 17

PACKAGING:	<b>CLAMSHELL 1 pcs</b>
Q.TY x MASTER PACK:	600 pcs
DIM. MASTER CARTON:	41 x 41 x 42 h cm
TOTAL WEIGHT:	20 kg
ORDER MULTIPLES OF:	<b>50 pcs</b>



CYLINDER & PISTON - PISTONRING

CYLINDER & PISTON - PISTONRING



## CYLINDER ASSY

SUITABLE FOR THE FOLLOWING CHAIN SAWS

MAKE FITS	<b>HUSQVARNA 272XP</b>
DESCRIPTION	<b>Cylinder assy ø 52 mm</b>
P/N	<b>88570011</b>
O.E.M. REF	503 75 81-72

PACKAGING:	<b>SINGLE BOX</b>
Q.TY x MASTER PACK:	27 pcs
DIM. MASTER CARTON:	36 x 33 x 35 h cm
TOTAL WEIGHT:	21,5 kg
ORDER MULTIPLES OF:	<b>1 pcs</b>

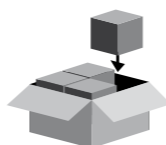

## CYLINDER ASSY

SUITABLE FOR THE FOLLOWING BLOWER

MAKE FITS	<b>SOLO PORT 423/S</b>
DESCRIPTION	<b>Cylinder assy ø 48 mm</b>
P/N	<b>88570012</b>
O.E.M. REF	22 00 935

PACKAGING:	<b>SINGLE BOX</b>
Q.TY x MASTER PACK:	27 pcs
DIM. MASTER CARTON:	36 x 33 x 35 h cm
TOTAL WEIGHT:	21,5 kg
ORDER MULTIPLES OF:	<b>1 pcs</b>

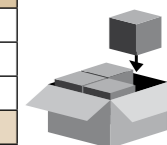

## PISTON ASSY

SUITABLE FOR THE FOLLOWING CHAIN SAWS

MAKE FITS	<b>HUSQVARNA 272XP</b>
DESCRIPTION	<b>Piston assy ø 52 mm</b>
P/N	<b>88572006</b>
O.E.M. REF	503 60 98-03

PACKAGING:	<b>SINGLE BOX</b>
Q.TY x MASTER PACK:	150 pcs
DIM. MASTER CARTON:	42 x 42 x 42 h cm
TOTAL WEIGHT:	21,5 kg
ORDER MULTIPLES OF:	<b>1 pcs</b>

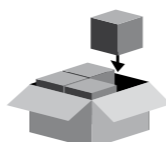

## PISTON ASSY

SUITABLE FOR THE FOLLOWING BLOWER

MAKE FITS	<b>SOLO PORT 423/S</b>
DESCRIPTION	<b>Piston assy ø 48 mm</b>
P/N	<b>88572007</b>
O.E.M. REF	00 55 122

PACKAGING:	<b>SINGLE BOX</b>
Q.TY x MASTER PACK:	150 pcs
DIM. MASTER CARTON:	42 x 42 x 42 h cm
TOTAL WEIGHT:	21,5 kg
ORDER MULTIPLES OF:	<b>1 pcs</b>

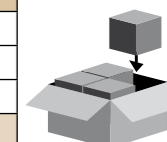

## PISTON RING SET

SUITABLE FOR THE FOLLOWING CHAIN SAWS

MAKE FITS	<b>HUSQVARNA 272XP</b>
DESCRIPTION	<b>Piston ring ø 52 mm</b>
P/N	<b>88574004</b>
O.E.M. REF	503 28 90-19

PACKAGING:	<b>CLAMSHELL 2 pcs</b>
Q.TY x MASTER PACK:	600 pcs
DIM. MASTER CARTON:	41 x 41 x 42 h cm
TOTAL WEIGHT:	25 kg
ORDER MULTIPLES OF:	<b>100 pcs</b>



## PISTON RING SET

SUITABLE FOR THE FOLLOWING BLOWER

MAKE FITS	<b>SOLO PORT 423/S</b>
DESCRIPTION	<b>Piston ring ø 48 mm</b>
P/N	<b>88574005</b>
O.E.M. REF	20 48 116

PACKAGING:	<b>CLAMSHELL 2 pcs</b>
Q.TY x MASTER PACK:	600 pcs
DIM. MASTER CARTON:	41 x 41 x 42 h cm
TOTAL WEIGHT:	25 kg
ORDER MULTIPLES OF:	<b>100 pcs</b>



PISTON RING



## PISTON RING SET

SUITABLE FOR THE FOLLOWING CHAIN SAWS

MAKE FITS	Ø mm	P/N	O.E.M. REF
<b>STIHL 070</b>	58	<b>88574603</b>	1106 034 3003
<b>STIHL 038 MAGNUM MS381-MS380-MS382</b>	52	<b>88574106</b>	1115 034 3010
<b>STIHL TS400</b>	49	<b>88574143</b>	1127 034 3006
<b>STIHL MS361</b>	47	<b>88574000</b>	1135 034 3010
<b>STIHL MS660</b>	54	<b>88574002</b>	1122 034 3001

FOR ALL PACKAGING:	<b>CLAMSHELL 2 pcs</b>
Q.TY x MASTER PACK:	1200 pcs
DIM. MASTER CARTON:	41 x 41 x 42 h cm
TOTAL WEIGHT:	25 kg
ORDER MULTIPLES OF:	<b>100 pcs</b>

\*Our P/N is referred to 1 piece



## PISTON RING SET

SUITABLE FOR THE FOLLOWING CHAIN SAWS

MAKE FITS	Ø mm	P/N	O.E.M. REF
<b>HUSQVARNA 268-268S-268K</b>	50	<b>88574142</b>	503 28 90 17

FOR ALL PACKAGING:	<b>CLAMSHELL 1 pcs</b>
Q.TY x MASTER PACK:	600 pcs
DIM. MASTER CARTON:	41 x 41 x 42 h cm
TOTAL WEIGHT:	20 kg
ORDER MULTIPLES OF:	<b>50 pcs</b>

\*Our P/N is referred to 1 piece

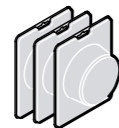

MAKE FITS	Ø mm	P/N	O.E.M. REF
<b>HUSQVARNA 272XP</b>	52	<b>88574004</b>	503 28 90-19

FOR ALL PACKAGING:	<b>CLAMSHELL 2 pcs</b>
Q.TY x MASTER PACK:	600 pcs
DIM. MASTER CARTON:	41 x 41 x 42 h cm
TOTAL WEIGHT:	25 kg
ORDER MULTIPLES OF:	<b>100 pcs</b>

\*Our P/N is referred to 1 piece



## CRANKSHAFT ASSY

SUITABLE FOR THE FOLLOWING CHAIN SAWS

MAKE FITS	<b>STIHL 070</b>
DESCRIPTION	<b>Crankshaft assy Oil seals, tab, nuts included</b>
P/N	<b>88590181</b>
O.E.M. REF	1106 030 0400

PACKAGING:	<b>SINGLE BOX</b>
Q.TY x MASTER PACK:	28 pcs
DIM. MASTER CARTON:	41 x 41 x 41 h cm
TOTAL WEIGHT:	32 kg
ORDER MULTIPLES OF:	<b>1 pcs</b>

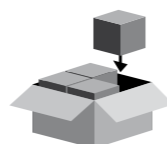

## CRANKSHAFT ASSY

SUITABLE FOR THE FOLLOWING CHAIN SAWS

MAKE FITS	<b>STIHL 038 - 038 SUPER 038 MAGNUM MS380 - MS381</b>
DESCRIPTION	<b>Crankshaft assy</b>
P/N	<b>88590150</b>
O.E.M. REF	1119 030 0400

PACKAGING:	<b>SINGLE BOX</b>
Q.TY x MASTER PACK:	48 pcs
DIM. MASTER CARTON:	41 x 41 x 41 h cm
TOTAL WEIGHT:	30 kg
ORDER MULTIPLES OF:	<b>1 pcs</b>

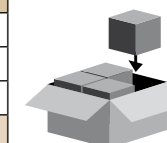

## CRANKSHAFT ASSY

SUITABLE FOR THE FOLLOWING CHAIN SAWS

MAKE FITS	<b>STIHL TS400</b>
DESCRIPTION	<b>Crankshaft assy</b>
P/N	<b>88590156</b>
O.E.M. REF	4223 030 0400

PACKAGING:	<b>SINGLE BOX</b>
Q.TY x MASTER PACK:	48 pcs
DIM. MASTER CARTON:	41 x 41 x 41 h cm
TOTAL WEIGHT:	30 kg
ORDER MULTIPLES OF:	<b>1 pcs</b>

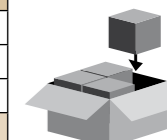

## CRANKSHAFT ASSY

SUITABLE FOR THE FOLLOWING CHAIN SAWS

MAKE FITS	<b>STIHL MS660</b>
DESCRIPTION	<b>Crankshaft assy</b>
P/N	<b>88590005</b>
O.E.M. REF	1122 030 0408

PACKAGING:	<b>SINGLE BOX</b>
Q.TY x MASTER PACK:	48 pcs
DIM. MASTER CARTON:	41 x 41 x 41 h cm
TOTAL WEIGHT:	30 kg
ORDER MULTIPLES OF:	<b>1 pcs</b>

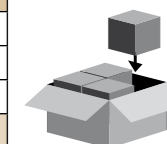

## **NEW** CRANKSHAFT ASSY

SUITABLE FOR THE FOLLOWING CHAIN SAWS

MAKE FITS	<b>STIHL MS651 - 661</b>
DESCRIPTION	<b>Crankshaft assy</b>
P/N	<b>88590008</b>
O.E.M. REF	1144 030 0402

PACKAGING:	<b>SINGLE BOX</b>
Q.TY x MASTER PACK:	48 pcs
DIM. MASTER CARTON:	41 x 41 x 41 h cm
TOTAL WEIGHT:	30 kg
ORDER MULTIPLES OF:	<b>1 pcs</b>

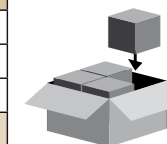

GASKET SET - NUT - CRANKSHAFT ASSY



## CRANKSHAFT ASSY

SUITABLE FOR THE FOLLOWING CHAIN SAWS

MAKE FITS	<b>STIHL MS382</b>
DESCRIPTION	Crankshaft assy
P/N	<b>88590007</b>
O.E.M. REF	1119 030 0402

PACKAGING:	<b>SINGLE BOX</b>
Q.TY x MASTER PACK:	48 pcs
DIM. MASTER CARTON:	41 x 41 x 41 h cm
TOTAL WEIGHT:	30 kg
ORDER MULTIPLES OF:	<b>1 pcs</b>

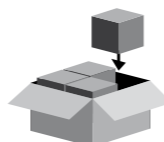

## CRANKCASE ASSY W/BEARING

SUITABLE FOR THE FOLLOWING CHAIN SAWS

MAKE FITS	<b>HUSQVARNA 272XP</b>
DESCRIPTION	Crankcase assy w/bearing
P/N	<b>88649197</b>
O.E.M. REF	501 77 99-01

PACKAGING:	<b>SINGLE BOX</b>
Q.TY x MASTER CARTON	9 pcs
TOTAL WEIGHT:	14 kg
ORDER MULTIPLES OF:	<b>12 pcs</b>

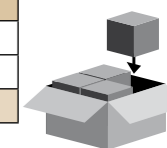

## CRANKSHAFT ASSY

SUITABLE FOR THE FOLLOWING CHAIN SAWS

MAKE FITS	<b>HUSQVARNA 61-268-272XP</b>
DESCRIPTION	Crankshaft assy
P/N	<b>88590165</b>
O.E.M. REF	503 61 33-71

PACKAGING:	<b>SINGLE BOX</b>
Q.TY x MASTER PACK:	48 pcs
DIM. MASTER CARTON:	41 x 41 x 41 h cm
TOTAL WEIGHT:	30 kg
ORDER MULTIPLES OF:	<b>1 pcs</b>

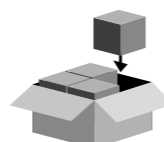

## CRANKCASE ASSY W/BEARING

SUITABLE FOR THE FOLLOWING CHAIN SAWS

MAKE FITS	<b>STIHL 070</b>
DESCRIPTION	Crankcase assy w/bearing
P/N	<b>88649194</b>
O.E.M. REF	1106 020 2506

PACKAGING:	<b>SINGLE BOX</b>
MASTER CARTON:	73 x 42 x 64 h cm
TOTAL WEIGHT:	38 kg
MAX. Q.TY PER PALLET:	120 pcs
ORDER MULTIPLES OF:	<b>12 pcs</b>

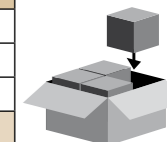

## NUT

SUITABLE FOR THE FOLLOWING CHAIN SAWS

MAKE FITS	<b>STIHL 070</b>
DESCRIPTION	Nuts
BAR NUT	P/N 88670190
SPROCKET NUT	P/N 88671102
FLYWHEEL NUT	P/N 88672110

PACKAGING:	<b>NYLON BAG</b>
Q.TY x MASTER PACK:	1200 pcs
MASTER CARTON:	27 x 16 x 13 h cm
TOTAL WEIGHT:	17,3 kg
ORDER MULTIPLES OF:	<b>10 pcs</b>



## CRANKCASE ASSY W/BEARING

SUITABLE FOR THE FOLLOWING CHAIN SAWS

MAKE FITS	<b>STIHL 038M</b>
DESCRIPTION	Crankcase assy w/bearing
P/N	<b>88649195</b>
O.E.M. REF	1119 020 2120

PACKAGING:	<b>SINGLE BOX</b>
MASTER CARTON:	9 pcs
TOTAL WEIGHT:	14 Kg
MAX. Q.TY PER PALLET:	120 pcs
ORDER MULTIPLES OF:	<b>12 pcs</b>

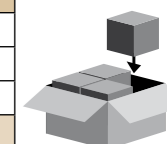

## GASKET SET KIT

SUITABLE FOR THE FOLLOWING CHAIN SAWS

DESCRIPTION	MAKE FITS	P/N
Gasket sets	<b>STIHL 070</b>	<b>88640137</b>
Gasket sets	<b>STIHL MS660</b>	<b>88640101</b>
Gasket sets	<b>STIHL MS382</b>	<b>88640103</b>
Gasket sets	<b>HUSQVARNA 272XP</b>	<b>88640102</b>

PACKAGING:	<b>NYLON BAG</b>
Q.TY x MASTER PACK:	360 sets
DIM. MASTER CARTON:	44 x 26 x 29 h cm
TOTAL WEIGHT:	13,3 kg
ORDER MULTIPLES OF:	<b>1 pcs</b>



## CRANKCASE ASSY W/BEARING

SUITABLE FOR THE FOLLOWING CHAIN SAWS

MAKE FITS	<b>STIHL MS660</b>
DESCRIPTION	Crankcase assy w/bearing
P/N	<b>88649196</b>
O.E.M. REF	1122 020 2113

PACKAGING:	<b>SINGLE BOX</b>
MASTER CARTON:	9 pcs
TOTAL WEIGHT:	14 Kg
MAX. Q.TY PER PALLET:	120 pcs
ORDER MULTIPLES OF:	<b>12 pcs</b>

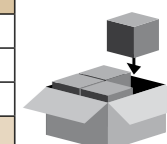

CRANKCASE ASSY W/BEARING



## HANDLE SHROUD ASSY

SUITABLE FOR THE FOLLOWING CHAIN SAWS

MAKE FITS	<b>STIHL 070</b>
DESCRIPTION	Handle Shroud Assy
P/N	<b>88542210</b>
O.E.M. REF	1106 080 1600

PACKAGING:	<b>SINGLE BOX</b>
Q.TY x MASTER PACK:	8 pcs
DIM. MASTER CARTON:	41 x 41 x 41 h cm
TOTAL WEIGHT:	8,7 kg
ORDER MULTIPLES OF:	<b>8 pcs</b>

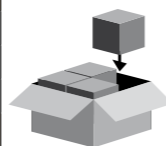

## CARBURETTOR COVER ASSY

SUITABLE FOR THE FOLLOWING CHAIN SAWS

MAKE FITS	<b>STIHL MS382</b>
DESCRIPTION	Carburettor Cover Assy
P/N	<b>88542212</b>
O.E.M. REF	1119 140 1907

PACKAGING:	<b>SINGLE BOX</b>
Q.TY x MASTER PACK:	1 pcs
ORDER MULTIPLES OF:	<b>1 pcs</b>



## CHAIN/SPROCKET COVER

SUITABLE FOR THE FOLLOWING CHAIN SAWS

MAKE FITS	<b>STIHL 070</b>
DESCRIPTION	Chain/Sprocket Cover
P/N	<b>88650158</b>
O.E.M. REF	1106 648 0412

PACKAGING:	<b>NYLON BAG</b>
Q.TY x MASTER PACK:	20 pcs
DIM. MASTER CARTON:	44 x 26 x 29 h cm
TOTAL WEIGHT:	7 kg
ORDER MULTIPLES OF:	<b>20 pcs</b>



## FAN COVER ASSY

SUITABLE FOR THE FOLLOWING CHAIN SAWS

MAKE FITS	<b>STIHL 070</b>
DESCRIPTION	Fan Cover Only
P/N	<b>88562212</b>
O.E.M. REF	1106 080 2802

PACKAGING:	<b>SINGLE BOX</b>
Q.TY x MASTER PACK:	20 pcs
MASTER CARTON:	41 x 41 x 41 h cm
TOTAL WEIGHT:	12 kg
ORDER MULTIPLES OF:	<b>1 pcs</b>

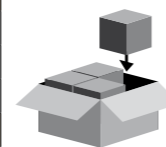

## OIL FILLER CAP

SUITABLE FOR THE FOLLOWING CHAIN SAWS

MAKE FITS	<b>STIHL 070</b>
DESCRIPTION	Oil Filler Cap
P/N	<b>88602202</b>
O.E.M. REF	1106 350 4002

PACKAGING:	<b>NYLON BAG</b>
Q.TY x MASTER PACK:	48 pcs
DIM. MASTER CARTON:	42 x 41 x 24 h cm
TOTAL WEIGHT:	7,8 kg
ORDER MULTIPLES OF:	<b>42 pcs</b>



## CHAIN TIGHTENER

SUITABLE FOR THE FOLLOWING CHAIN SAWS

MAKE FITS	<b>STIHL 070</b>	P/N <b>88651157</b>
		O.E.M. REF 1106 664 1501

MAKE FITS	<b>STIHL MS382</b>	P/N <b>88651101</b>
		O.E.M. REF 1125 007 1021

PACKAGING:	<b>NYLON BAG</b>
Q.TY x MASTER CARTON:	10 pcs
ORDER MULTIPLES OF:	<b>10 pcs</b>



## FUEL CAPS

SUITABLE FOR THE FOLLOWING CHAIN SAWS

MAKE FITS	P/N	O.E.M. REF
<b>STIHL 070</b>	<b>88550121</b>	1107 350 0500
<b>STIHL MS660</b>	<b>88550124</b>	0000 350 0503
<b>STIHL 038M</b>	<b>88550123</b>	0000 350 0520
<b>STIHL MS381 - 382</b>	<b>88550128</b>	0000 350 0533
<b>HUSQVARNA 268 - 272XP</b>	<b>88550126</b>	501 43 14-02

PACKAGING:	<b>NYLON BAG</b>
Q.TY x MASTER PACK:	5 pcs
ORDER MULTIPLES OF:	<b>5 pcs</b>



## OIL CAPS

SUITABLE FOR THE FOLLOWING CHAIN SAWS

MAKE FITS	P/N	O.E.M. REF
<b>STIHL MS660</b>	<b>88550125</b>	0000 350 0520
<b>STIHL 038M</b>	<b>88550122</b>	0000 350 0510
<b>STIHL MS381 - 382</b>	<b>88550129</b>	0000 350 0537
<b>HUSQVARNA 268 - 272XP</b>	<b>88550127</b>	501 62 66-02

PACKAGING:	<b>NYLON BAG</b>
Q.TY x MASTER PACK:	5 pcs
ORDER MULTIPLES OF:	<b>5 pcs</b>





## TUBE HANDLE

SUITABLE FOR THE FOLLOWING CHAIN SAWS

MAKE FITS	P/N	O.E.M. REF
STIHL 070	<b>88654193</b>	1106 790 1501
STIHL MS660-651-661	<b>99-660-N1</b>	0000 791 2009
STIHL MS381 - 382	<b>88654194</b>	1119 790 1701
HUSQVARNA 272XP	<b>99-272-M2</b>	501 53 45-03

PACKAGING:	NYLON BAG
Q.TY x MASTER PACK:	35 pcs
DIM. MASTER CARTON:	41 x 41 x 41 h cm
TOTAL WEIGHT:	14,7 kg
ORDER MULTIPLES OF:	<b>1 pcs</b>

**NEW**

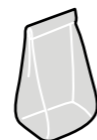

## GRIP

SUITABLE FOR THE FOLLOWING CHAIN SAWS

MAKE FITS	STIHL 070-038M-MS381 MS660 - MS382
DESCRIPTION	Grip
P/N	<b>88560213</b>
O.E.M. REF	1110 195 3400

PACKAGING:	NYLON BAG
Q.TY x MASTER PACK:	590 pcs
MASTER CARTON:	44 x 26 x 29 h cm
TOTAL WEIGHT:	12,6 kg
ORDER MULTIPLES OF:	<b>5 pcs</b>



## PAWL

SUITABLE FOR THE FOLLOWING CHAIN SAWS

MAKE FITS	STIHL 070-038M-381- 660-084-TS360-051-056 064-066-382
DESCRIPTION	Pawls
P/N	<b>88560202</b>
O.E.M. REF	1124 195 7200

PACKAGING:	NYLON BAG
Q.TY x MASTER PACK:	6.000 pcs
DIM. MASTER CARTON:	44 x 26 x 29 h cm
TOTAL WEIGHT:	13,6 kg
ORDER MULTIPLES OF:	<b>10 pcs</b>



## STARTER ROPE

UNIVERSAL

DESCRIPTION	P/N
Spool Ø 3 mm x 100 m	<b>88560125</b>
Spool Ø 3.5 mm x 100 m	<b>88560126</b>
Spool Ø 4 mm x 100 m	<b>88560127</b>
Spool Ø 4.5 mm x 100 m	<b>88560128</b>

PACKAGING:	SPOOL
Q.TY x MASTER PACK:	1 pcs
ORDER MULTIPLES OF:	<b>1 pcs (1 spool)</b>

\*The PRICE is referred to 100 m of spool



STIHL 070  
P/N **88561178**



STIHL MS660  
P/N **88561179**

**NEW**



STIHL MS382  
P/N **88561181**



HUSQVARNA 272XP  
P/N **88561180**

## REWIND SPRING

SUITABLE FOR THE FOLLOWING CHAIN SAWS

MAKE FITS	STIHL 070
DESCRIPTION	Starter Spring
P/N	<b>88561178</b>

MAKE FITS	STIHL MS660 - 651 - 661
DESCRIPTION	Starter Spring
P/N	<b>88561179</b>

MAKE FITS	STIHL MS382
DESCRIPTION	Starter Spring
P/N	<b>88561181</b>

MAKE FITS	HUSQVARNA 272XP
DESCRIPTION	Rewind Spring
P/N	<b>88561180</b>

PACKAGING:	BLISTER
Q.TY x MASTER PACK:	1 pcs
ORDER MULTIPLES OF:	<b>1 pcs</b>



STIHL 070-038M-MS381  
P/N **88560224**



STIHL MS660  
P/N **88560225**



STIHL MS382  
P/N **88560227**



HUSQVARNA 272XP  
P/N **88560226**

## STARTER PULLEY

SUITABLE FOR THE FOLLOWING CHAIN SAWS

MAKE FITS	STIHL 070-038M-MS381
DESCRIPTION	Starter Pulley
P/N	<b>88560224</b>

MAKE FITS	STIHL MS660 - 651 - 661
DESCRIPTION	Starter Pulley
P/N	<b>88560225</b>

MAKE FITS	STIHL MS382
DESCRIPTION	Starter Pulley
P/N	<b>88560227</b>

MAKE FITS	HUSQVARNA 272XP
DESCRIPTION	Starter Pulley
P/N	<b>88560226</b>

PACKAGING:	NYLON BAG
Q.TY x MASTER PACK:	5 pcs
ORDER MULTIPLES OF:	<b>5 pcs</b>





## AIR FILTER

SUITABLE FOR THE FOLLOWING CHAIN SAWS

MAKE FITS	<b>STIHL 070</b>
DESCRIPTION	Air filter
P/N	<b>88540218</b>
O.E.M. REF	1106 120 1602

PACKAGING:	<b>NYLON BAG</b>
Q.TY x MASTER PACK:	310 pcs
DIM. MASTER CARTON:	41 x 41 x 41 h cm
TOTAL WEIGHT:	7,5 kg
ORDER MULTIPLES OF:	<b>10 pcs</b>

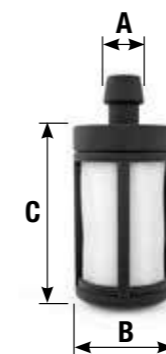

## FUEL FILTER SUPER TYPE WITH SYNTETIC POLYMERS ELEMENT

UNIVERSAL

MAKE FITS	DESCRIPTION	Conn. Ø A mm	Body Ø B mm	h C mm	P/N
STIHL fitting	Fuel pick up filter	8.2	17.7	33.0	<b>88524159</b>
STIHL fitting	Fuel pick up filter	8.2	20.8	34.4	<b>88524133</b>
TILLOTSON - STANDARD fitting	Fuel pick up filter	6.2	18.4	33.0	<b>88524123</b>
HUSQVARNA fitting	Fuel pick up filter	5.3	17.7	33.0	<b>88524160</b>
HUSQVARNA fitting	Fuel pick up filter	4.1	13.5	23.0	<b>88524161</b>

PACKAGING:	Q.TY x MASTER PACK:	ORDER MULTIPLES OF:
NYLON BAG	10 pcs	<b>10 pcs</b>



## AIR FILTER

SUITABLE FOR THE FOLLOWING CHAIN SAWS

MAKE FITS	<b>STIHL 038M-MS381 MS382</b>
DESCRIPTION	Air filter
P/N	<b>88540220</b>
O.E.M. REF	1119 120 1625

PACKAGING:	<b>NYLON BAG</b>
Q.TY x MASTER PACK:	1 pcs
ORDER MULTIPLES OF:	<b>1 pcs</b>

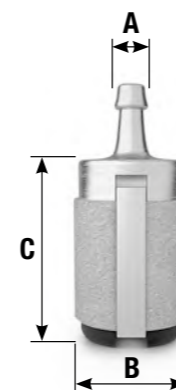

## FUEL FILTER FELT TYPE

UNIVERSAL

MAKE FITS	DESCRIPTION	Conn. Ø A mm	Body Ø B mm	h C mm	P/N
WALBRO fitting	Fuel filter up to 80cc	5.3	20.9	27.6	<b>88524162</b>
WALBRO fitting	Fuel filter up to 125cc	5.3	21.4	31.8	<b>88524163</b>
WALBRO fitting	Fuel filter up to 30cc	5.3	15.3	25.2	<b>88524164</b>

PACKAGING:	Q.TY x MASTER PACK:	ORDER MULTIPLES OF:
NYLON BAG	10 pcs	<b>10 pcs</b>



## AIR FILTER

SUITABLE FOR THE FOLLOWING CHAIN SAWS

MAKE FITS	<b>STIHL MS660</b>
DESCRIPTION	Air filter
P/N	<b>88540219</b>
O.E.M. REF	0000 120 1654

PACKAGING:	<b>NYLON BAG</b>
Q.TY x MASTER PACK:	1 pcs
ORDER MULTIPLES OF:	<b>1 pcs</b>

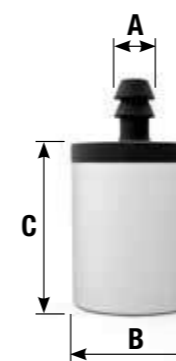

## FUEL FILTER SYNTETIC POLYMERS TYPE

UNIVERSAL

MAKE FITS	DESCRIPTION	Conn. Ø A mm	Body Ø B mm	h C mm	P/N
- fitting	Fuel pick up filter	6.2	21.4	27.6	<b>88524154</b>
- fitting	Fuel pick up filter	4.1	21.4	26.0	<b>88524148</b>
- fitting	Fuel pick up filter	5.3	21.4	26.5	<b>88524158</b>
- fitting	Fuel pick up filter	8.2	21.4	26.5	<b>88524155</b>

PACKAGING:	Q.TY x MASTER PACK:	ORDER MULTIPLES OF:
NYLON BAG	10 pcs	<b>10 pcs</b>



## AIR FILTER

SUITABLE FOR THE FOLLOWING CHAIN SAWS

MAKE FITS	<b>HUSQVARNA 272XP</b>
DESCRIPTION	Air filter
P/N	<b>88540221</b>
O.E.M. REF	503 44 72-03

PACKAGING:	<b>NYLON BAG</b>
Q.TY x MASTER PACK:	1 pcs
ORDER MULTIPLES OF:	<b>1 pcs</b>

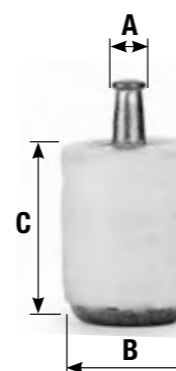

## FUEL FILTER FELT TYPE

UNIVERSAL

MAKE FITS	DESCRIPTION	Conn. Ø A mm	Body Ø B mm	h C mm	P/N
TILLOTSON - STANDARD fitting	Fuel pick up filter	6.2	21	28	<b>88524166</b>

PACKAGING:	Q.TY x MASTER PACK:	ORDER MULTIPLES OF:
NYLON BAG	10 pcs	<b>10 pcs</b>





## OIL PUMP ASSY

SUITABLE FOR THE FOLLOWING CHAIN SAWS

MAKE FITS	<b>STIHL 070</b>
DESCRIPTION	<b>Oil Pump Assy</b>
P/N	<b>88601214</b>
O.E.M. REF	1106 640 3202

PACKAGING:	<b>SINGLE BOX</b>
Q.TY x MASTER PACK:	20 pcs
MASTER CARTON:	25 x 25 x 12 h cm
TOTAL WEIGHT:	4 kg
ORDER MULTIPLES OF:	<b>20 pcs</b>

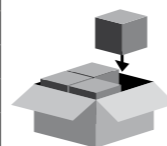

## OIL PUMP DIAPHRAGM

SUITABLE FOR THE FOLLOWING CHAIN SAWS

MAKE FITS	<b>STIHL 070</b>
DESCRIPTION	<b>Oil Pump Diaphragm</b>
P/N	<b>88601183</b>
O.E.M. REF	1106 640 3100

PACKAGING:	<b>CARDBOARD</b>
Q.TY x MASTER PACK:	864 pcs
MASTER CARTON:	41 x 41 x 41 h cm
TOTAL WEIGHT:	15 kg
ORDER MULTIPLES OF:	<b>72 pcs</b>

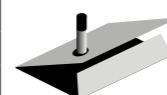

## OIL PUMP ASSY

SUITABLE FOR THE FOLLOWING CHAIN SAWS

MAKE FITS	<b>STIHL MS660</b>
DESCRIPTION	<b>Oil Pump Assy</b>
P/N	<b>88601216</b>
O.E.M. REF	1122 640 3205

PACKAGING:	<b>SINGLE BOX</b>
Q.TY x MASTER PACK:	30 pcs
MASTER CARTON:	28 x 26 x 15 h cm
TOTAL WEIGHT:	3,7 kg
ORDER MULTIPLES OF:	<b>30 pcs</b>

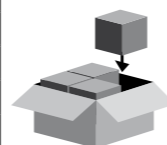

## WORM GEAR

SUITABLE FOR THE FOLLOWING CHAIN SAWS

MAKE FITS	<b>STIHL MS660</b>
DESCRIPTION	<b>Worm Gear</b>
P/N	<b>88601219</b>
O.E.M. REF	1122 640 7105

PACKAGING:	<b>NYLON BAG</b>
Q.TY x MASTER PACK:	1 pcs
ORDER MULTIPLES OF:	<b>1 pcs</b>



## **NEW** OIL PUMP ASSY

SUITABLE FOR THE FOLLOWING CHAIN SAWS

MAKE FITS	<b>STIHL MS651 - 661</b>
DESCRIPTION	<b>Oil Pump Assy</b>
P/N	<b>88601225</b>
O.E.M. REF	1144 640 3200

PACKAGING:	<b>SINGLE BOX</b>
Q.TY x MASTER PACK:	30 pcs
MASTER CARTON:	28 x 26 x 15 h cm
TOTAL WEIGHT:	3,7 kg
ORDER MULTIPLES OF:	<b>30 pcs</b>

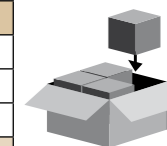

## **NEW** WORM GEAR

SUITABLE FOR THE FOLLOWING CHAIN SAWS

MAKE FITS	<b>STIHL MS651 - 661</b>
DESCRIPTION	<b>Worm Gear</b>
P/N	<b>88601226</b>
O.E.M. REF	1144 640 7101

PACKAGING:	<b>NYLON BAG</b>
Q.TY x MASTER PACK:	1 pcs
ORDER MULTIPLES OF:	<b>1 pcs</b>

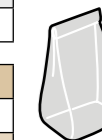

## OIL PUMP ASSY

SUITABLE FOR THE FOLLOWING CHAIN SAWS

MAKE FITS	<b>STIHL 038M-MS381</b>
DESCRIPTION	<b>Oil Pump Assy</b>
P/N	<b>88601215</b>
O.E.M. REF	1119 640 3200

PACKAGING:	<b>SINGLE BOX</b>
Q.TY x MASTER PACK:	30 pcs
MASTER CARTON:	28 x 26 x 15 h cm
TOTAL WEIGHT:	3,7 kg
ORDER MULTIPLES OF:	<b>30 pcs</b>

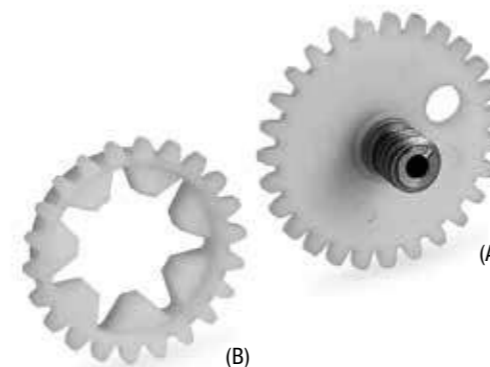
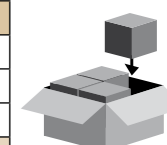

## WORM + GEAR KIT

SUITABLE FOR THE FOLLOWING CHAIN SAWS

MAKE FITS	<b>STIHL 038M-MS381</b>
DESCRIPTION	<b>Worm + Gear</b>
P/N	<b>88601217</b>
(A) O.E.M. REF	1119 640 7100
(B) O.E.M. REF	1119 642 1501

PACKAGING:	<b>NYLON BAG</b>
Q.TY x MASTER PACK:	1 pcs
ORDER MULTIPLES OF:	<b>1 pcs</b>





## OIL PUMP ASSY

SUITABLE FOR THE FOLLOWING CHAIN SAWS

MAKE FITS	<b>STIHL MS382</b>
DESCRIPTION	<b>Oil Pump Assy</b>
<b>P/N</b>	<b>88601223</b>
O.E.M. REF	1142 640 3200

PACKAGING:	<b>SINGLE BOX</b>
Q.TY x MASTER PACK:	30 pcs
MASTER CARTON:	28 x 26 x 15 h cm
TOTAL WEIGHT:	3,7 kg
ORDER MULTIPLES OF:	<b>30 pcs</b>

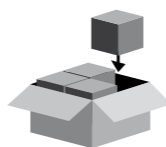

## WORM + SPRING KIT

SUITABLE FOR THE FOLLOWING CHAIN SAWS

MAKE FITS	<b>STIHL MS382</b>
DESCRIPTION	<b>Worm + Spring</b>
<b>P/N</b>	<b>88601224</b>
(A) O.E.M. REF	1128 640 7112
(B) O.E.M. REF	1128 647 2400

PACKAGING:	<b>NYLON BAG</b>
Q.TY x MASTER PACK:	1 pcs
ORDER MULTIPLES OF:	<b>1 pcs</b>



## OIL PUMP ASSY

SUITABLE FOR THE FOLLOWING CHAIN SAWS

MAKE FITS	<b>HUSQVARNA 272XP</b>
DESCRIPTION	<b>Oil Pump Assy</b>
<b>P/N</b>	<b>88601221</b>
O.E.M. REF	501 51 25-01

PACKAGING:	<b>SINGLE BOX</b>
Q.TY x MASTER PACK:	20 pcs
MASTER CARTON:	25 x 25 x 12 h cm
TOTAL WEIGHT:	4 kg
ORDER MULTIPLES OF:	<b>20 pcs</b>

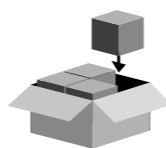

## WORM GEAR

SUITABLE FOR THE FOLLOWING CHAIN SAWS

MAKE FITS	<b>HUSQVARNA 272XP</b>
DESCRIPTION	<b>Worm Gear</b>
<b>P/N</b>	<b>88601222</b>
O.E.M. REF	503 26 02-04

PACKAGING:	<b>NYLON BAG</b>
Q.TY x MASTER PACK:	1 pcs
ORDER MULTIPLES OF:	<b>1 pcs</b>



## CARBURETTOR

SUITABLE FOR THE FOLLOWING CHAIN SAWS

MAKE FITS	<b>STIHL 070</b>
DESCRIPTION	<b>Carburettor</b>
<b>P/N</b>	<b>88520192</b>
O.E.M. REF	1106 120 0607

PACKAGING:	<b>SINGLE BOX</b>
Q.TY x MASTER PACK:	36 pcs
MASTER CARTON:	43 x 25 x 28 h cm
TOTAL WEIGHT:	14,7 kg
ORDER MULTIPLES OF:	<b>36 pcs</b>

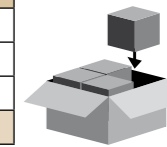

## CARBURETTOR

SUITABLE FOR THE FOLLOWING CHAIN SAWS

MAKE FITS	<b>STIHL MS660</b>
DESCRIPTION	<b>Carburettor</b>
<b>P/N</b>	<b>88520003</b>
O.E.M. REF	1122 120 0621

PACKAGING:	<b>SINGLE BOX</b>
Q.TY x MASTER PACK:	48 pcs
MASTER CARTON:	28 x 26 x 15 h cm
TOTAL WEIGHT:	6,3 kg
ORDER MULTIPLES OF:	<b>48 pcs</b>

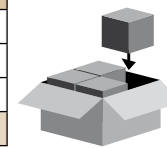

## NEW CARBURETTOR

SUITABLE FOR THE FOLLOWING CHAIN SAWS

MAKE FITS	<b>STIHL MS651</b>
DESCRIPTION	<b>Carburettor</b>
<b>P/N</b>	<b>88520008</b>
O.E.M. REF	1144 120 0605

PACKAGING:	<b>SINGLE BOX</b>
Q.TY x MASTER PACK:	48 pcs
MASTER CARTON:	28 x 26 x 15 h cm
TOTAL WEIGHT:	6,3 kg
ORDER MULTIPLES OF:	<b>48 pcs</b>

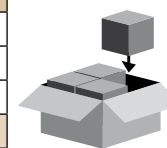

## CARBURETTOR

SUITABLE FOR THE FOLLOWING CHAIN SAWS

MAKE FITS	<b>STIHL 038M-MS381</b>
DESCRIPTION	<b>Carburettor</b>
<b>P/N</b>	<b>88520001</b>
O.E.M. REF	1119 120 0602

PACKAGING:	<b>SINGLE BOX</b>
Q.TY x MASTER PACK:	48 pcs
MASTER CARTON:	28 x 26 x 15 h cm
TOTAL WEIGHT:	6,3 kg
ORDER MULTIPLES OF:	<b>48 pcs</b>

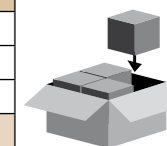



## CARBURETTOR

SUITABLE FOR THE FOLLOWING CHAIN SAWS

MAKE FITS	<b>STIHL MS382</b>
DESCRIPTION	Carburettor
P/N	<b>88520007</b>
O.E.M. REF	1119 120 0612

PACKAGING:	<b>SINGLE BOX</b>
Q.TY x MASTER PACK:	48 pcs
MASTER CARTON:	28 x 26 x 15 h cm
TOTAL WEIGHT:	6,3 kg
ORDER MULTIPLES OF:	<b>48 pcs</b>

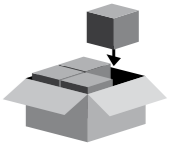

CARBURETTOR



## CARBURETTOR

SUITABLE FOR THE FOLLOWING CHAIN SAWS

MAKE FITS	<b>HUSQVARNA 272XP</b>
DESCRIPTION	Carburettor
P/N	<b>88520006</b>
O.E.M. REF	503 28 03-16

PACKAGING:	<b>SINGLE BOX</b>
Q.TY x MASTER PACK:	48 pcs
MASTER CARTON:	28 x 26 x 15 h cm
TOTAL WEIGHT:	6,3 kg
ORDER MULTIPLES OF:	<b>48 pcs</b>

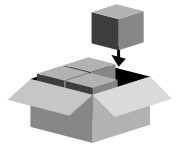

## CARBURETTOR

SUITABLE FOR THE FOLLOWING CHAIN SAWS

MAKE FITS	<b>52 SERIES China</b>
DESCRIPTION	Carburettor
P/N	<b>88520002</b>
O.E.M. REF	-

PACKAGING:	<b>SINGLE BOX</b>
Q.TY x MASTER PACK:	48 pcs
MASTER CARTON:	28 x 26 x 15 h cm
TOTAL WEIGHT:	6,3 kg
ORDER MULTIPLES OF:	<b>48 pcs</b>

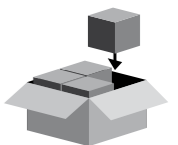

2 STROKE OIL - RUBBER FUEL LINE



## RUBBER FUEL LINE

UNIVERSAL

DESCRIPTION	
Ø 3.2 mm Rubber fuel line	P/N 88524106
Ø 4.5 mm Rubber fuel line	P/N 88524107

PACKAGING:	NYLON BAG
Q.TY x MASTER PACK:	5 m
ORDER MULTIPLES OF:	5 m (1 reel)

\*The PRICE is referred to 1 m of line



**2T** 2-Stroke Oil  
HIGH QUALITY

LONG LIFE  
TO YOUR  
ENGINE



## "HIGH QUALITY" 2 STROKE OIL - 1L

UNIVERSAL

DESCRIPTION	
Special formula 2T Oil	P/N 88300101
O.E.M. REF	-

PACKAGING:	BOTTLE 1 L
Q.TY x MASTER PACK:	24 Bottles
MASTER CARTON:	58,5 x 36,5 x 25,5 h cm
TOTAL WEIGHT:	24,8 kg
ORDER MULTIPLES OF:	24 pcs

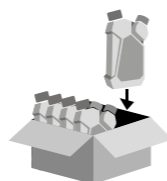

**2T** 2-Stroke Oil  
HIGH QUALITY

LONG LIFE  
TO YOUR  
ENGINE



## "ULTRALUBE" 2 STROKE OIL - 5L

UNIVERSAL

DESCRIPTION	
Special formula 2T Oil	P/N 88300103
O.E.M. REF	-

PACKAGING:	PLASTIC TANK 5 L
Q.TY x MASTER PACK:	4 Tanks
MASTER CARTON:	40 x 25 x 30 h cm
TOTAL WEIGHT:	4,6 kg
ORDER MULTIPLES OF:	4 pcs

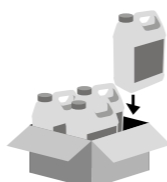

## EXHAUST

SUITABLE FOR THE FOLLOWING CHAIN SAWS

MAKE FITS	<b>STIHL 070</b>
DESCRIPTION	Exhausts
P/N	88610211
O.E.M. REF	1106 140 0502

PACKAGING:	NYLON BAG
Q.TY x MASTER PACK:	51 pcs
DIM. MASTER CARTON:	42 x 41 x 24 h cm
TOTAL WEIGHT:	14,4 kg
ORDER MULTIPLES OF:	1 pcs



EXHAUST



## EXHAUST

SUITABLE FOR THE FOLLOWING CHAIN SAWS

MAKE FITS	<b>STIHL MS660</b>
DESCRIPTION	Exhausts
P/N	88610212
O.E.M. REF	1122 140 0604

PACKAGING:	NYLON BAG
Q.TY x MASTER PACK:	51 pcs
DIM. MASTER CARTON:	42 x 41 x 24 h cm
TOTAL WEIGHT:	14,4 kg
ORDER MULTIPLES OF:	1 pcs



## EXHAUST

SUITABLE FOR THE FOLLOWING CHAIN SAWS

MAKE FITS	<b>STIHL 038M-MS381 MS382</b>
DESCRIPTION	Exhausts
P/N	88610213
O.E.M. REF	1119 140 0604

PACKAGING:	NYLON BAG
Q.TY x MASTER PACK:	51 pcs
DIM. MASTER CARTON:	42 x 41 x 24 h cm
TOTAL WEIGHT:	14,4 kg
ORDER MULTIPLES OF:	1 pcs



## EXHAUST

SUITABLE FOR THE FOLLOWING CHAIN SAWS

MAKE FITS	<b>HUSQVARNA 272XP</b>
DESCRIPTION	Exhausts
P/N	88610214
O.E.M. REF	503 59 92-06

PACKAGING:	NYLON BAG
Q.TY x MASTER PACK:	51 pcs
DIM. MASTER CARTON:	42 x 41 x 24 h cm
TOTAL WEIGHT:	14,4 kg
ORDER MULTIPLES OF:	1 pcs

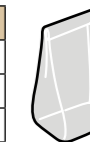



## CLUTCH ASSY

SUITABLE FOR THE FOLLOWING CHAIN SAWS

MAKE FITS	<b>STIHL 070</b>
DESCRIPTION	Clutch assy
P/N	<b>88620182</b>
O.E.M. REF	-

PACKAGING:	<b>BLISTER</b>
Q.TY x MASTER PACK:	25 pcs
MASTER CARTON:	28 x 26 x 14 h cm
TOTAL WEIGHT:	10,2 kg
ORDER MULTIPLES OF:	<b>25 pcs</b>



## CLUTCH ASSY

SUITABLE FOR THE FOLLOWING CHAIN SAWS

MAKE FITS	<b>STIHL MS382</b>
DESCRIPTION	Clutch assy
P/N	<b>88620186</b>
O.E.M. REF	1138 160 2010

PACKAGING:	<b>BLISTER</b>
Q.TY x MASTER PACK:	25 pcs
MASTER CARTON:	28 x 26 x 14 h cm
TOTAL WEIGHT:	10,2 kg
ORDER MULTIPLES OF:	<b>25 pcs</b>



## CLUTCH CARRIER-A

SUITABLE FOR THE FOLLOWING CHAIN SAWS

MAKE FITS	<b>STIHL 070</b>
DESCRIPTION	Clutch carrier conical type
P/N	<b>88623691</b>
O.E.M. REF	1106 162 3200

PACKAGING:	<b>BLISTER</b>
Q.TY x MASTER PACK:	180 pcs
DIM. MASTER CARTON:	27 x 26 x 13 h cm
TOTAL WEIGHT:	17,7 kg
ORDER MULTIPLES OF:	<b>1 pcs</b>



## CLUTCH ASSY

SUITABLE FOR THE FOLLOWING CHAIN SAWS

MAKE FITS	<b>STIHL MS660</b>
DESCRIPTION	Clutch assy
P/N	<b>88620183</b>
O.E.M. REF	1122 160 2005

PACKAGING:	<b>BLISTER</b>
Q.TY x MASTER PACK:	25 pcs
MASTER CARTON:	28 x 26 x 14 h cm
TOTAL WEIGHT:	10,2 kg
ORDER MULTIPLES OF:	<b>25 pcs</b>



## CLUTCH SPRING

SUITABLE FOR THE FOLLOWING CHAIN SAWS

MAKE FITS	<b>STIHL 070</b>
DESCRIPTION	Clutch spring
P/N	<b>88621142</b>
O.E.M. REF	0000 997 5905

PACKAGING:	<b>NYLON BAG</b>
Q.TY x MASTER PACK:	3.600 pcs
MASTER CARTON:	27 x 26 x 13 h cm
TOTAL WEIGHT:	11 kg
ORDER MULTIPLES OF:	<b>10 pcs</b>



## CLUTCH ASSY

SUITABLE FOR THE FOLLOWING CHAIN SAWS

MAKE FITS	<b>HUSQVARNA 272XP</b>
DESCRIPTION	Clutch assy
P/N	<b>88620185</b>
O.E.M. REF	503 74 44-02

PACKAGING:	<b>BLISTER</b>
Q.TY x MASTER PACK:	25 pcs
MASTER CARTON:	28 x 26 x 14 h cm
TOTAL WEIGHT:	10,2 kg
ORDER MULTIPLES OF:	<b>25 pcs</b>



## CLUTCH ASSY

SUITABLE FOR THE FOLLOWING CHAIN SAWS

MAKE FITS	<b>STIHL 038M-MS381</b>
DESCRIPTION	Clutch assy
P/N	<b>88620184</b>
O.E.M. REF	1119 160 2002

PACKAGING:	<b>BLISTER</b>
Q.TY x MASTER PACK:	25 pcs
MASTER CARTON:	28 x 26 x 14 h cm
TOTAL WEIGHT:	10,2 kg
ORDER MULTIPLES OF:	<b>25 pcs</b>



## FLYWHEEL

SUITABLE FOR THE FOLLOWING CHAIN SAWS

MAKE FITS	<b>STIHL 070</b>
DESCRIPTION	Flywheel
P/N	<b>88505184R</b>
O.E.M. REF	1106 400 1206

PACKAGING:	<b>SINGLE BOX</b>
Q.TY x MASTER PACK:	27 pcs
DIM. MASTER CARTON:	40 x 40 x 21 h cm
TOTAL WEIGHT:	29 kg
ORDER MULTIPLES OF:	<b>27 pcs</b>

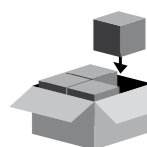



## INSULATED CABLE HIGH TEMPERATURES

UNIVERSAL

DESCRIPTION:	
Rubber insulated cable for HIGH TEMPERATURES from -20° +- 100°C	
Ø 5 mm	P/N 88506142

PACKAGING:	10 m for REEL (Nylon Bag)
Q.TY x MASTER PACK:	10 m
ORDER MULTIPLES OF:	10 m (1 reel)

\*The PRICE is referred to 1 m of cable



## STATOR ASSY

SUITABLE FOR THE FOLLOWING CHAIN SAWS

MAKE FITS	STIHL 070
DESCRIPTION	Stator assy
P/N	88505187

PACKAGING:	SINGLE BOX
Q.TY x MASTER PACK:	36 pcs
DIM. MASTER CARTON:	40 x 40 x 21 h cm
TOTAL WEIGHT:	13 kg
ORDER MULTIPLES OF:	36 pcs

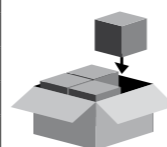

## SPARK PLUG

UNIVERSAL

ENGINE	Chain saw
P/N	88501157
HEXAGON	19
SUITABLE FOR	BOSCH WS7F
	CHAMPION CJ7Y
	NGK BPM7A

PACKAGING:	10 pcs x CARTON BOX
Q.TY x MASTER PACK:	280 pcs
DIM. MASTER CARTON:	38 x 36 x h 15 cm
TOTAL WEIGHT:	11,3 kg
ORDER MULTIPLES OF:	280 pcs

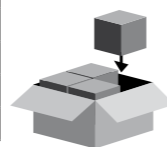

## SPARK PLUG TERMINAL + SPRING

SUITABLE FOR THE FOLLOWING CHAIN SAWS

MAKE FITS	STIHL 070
SPARK PLUG TERMINAL	P/N 88506120
LEG SPRING	P/N 88506121

PACKAGING:	10 pcs x NYLON BAG
Q.TY x MASTER PACK:	450 pcs
DIM. MASTER CARTON:	44 x 26 x h 29 cm
TOTAL WEIGHT:	5 kg
ORDER MULTIPLES OF:	10 pcs



## SPARK PLUG TERMINAL + SPRING

SUITABLE FOR THE FOLLOWING CHAIN SAWS

MAKE FITS	STIHL 038M-MS381 MS660-MS382
SPARK PLUG TERMINAL	P/N 88506122

PACKAGING:	10 pcs x NYLON BAG
ORDER MULTIPLES OF:	10 pcs



## IGNITION COIL

SUITABLE FOR THE FOLLOWING CHAIN SAWS

MAKE FITS	STIHL 036-038M MS381-MS660-MS382
DESCRIPTION	Ignition coils
P/N	88502191
O.E.M. REF	0000 400 1300

PACKAGING:	SINGLE BOX
Q.TY x MASTER PACK:	84 pcs
DIM. MASTER CARTON:	44 x 27 x h 31 cm
TOTAL WEIGHT:	16 kg
ORDER MULTIPLES OF:	84 pcs

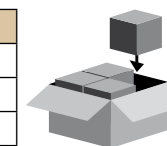

## IGNITION COIL

SUITABLE FOR THE FOLLOWING CHAIN SAWS

MAKE FITS	STIHL 070
DESCRIPTION	Ignition coils
P/N	88502190
O.E.M. REF	1106 404 3210

PACKAGING:	SINGLE BOX
Q.TY x MASTER PACK:	25 pcs
DIM. MASTER CARTON:	27 x 25 x h 12 cm
TOTAL WEIGHT:	3,5 kg
ORDER MULTIPLES OF:	1 pcs

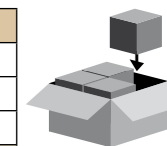

## POINT SET

SUITABLE FOR THE FOLLOWING CHAIN SAWS

MAKE FITS	STIHL 070
DESCRIPTION	Point set
P/N	88504189
O.E.M. REF	-

PACKAGING:	SINGLE BOX
Q.TY x MASTER PACK:	864 pcs
DIM. MASTER CARTON:	41 x 41 x h 41 cm
TOTAL WEIGHT:	20 kg
ORDER MULTIPLES OF:	72 pcs

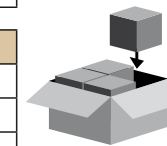

## CONDENSER

SUITABLE FOR THE FOLLOWING CHAIN SAWS

MAKE FITS	STIHL 070
DESCRIPTION	Condenser
P/N	88503199
O.E.M. REF	-

PACKAGING:	SINGLE BOX
Q.TY x MASTER PACK:	864 pcs
DIM. MASTER CARTON:	41 x 41 x h 41 cm
TOTAL WEIGHT:	15 kg
ORDER MULTIPLES OF:	72 pcs

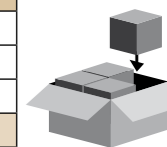

HEAVY DUTY CHAINSAW GUIDE BAR - CHAINSAW GUIDE BAR



## CHAINSAW GUIDE BAR

UNIVERSAL

P&T PART NUMBER	TYPE	LENGTH	PITCH	GAUGE	MOUNT	OREGON CROSS REF.	CARLTON CROSS REF.
88200101	HARDNOSE-PRO	36" - 90 cm	.404"	0,063"	STIHL 070	363ATLE099	3632063PH
88200102	HARDNOSE-PRO	20" - 50 cm	3/8"	0,063"	CHINESE 5200	203ATMK095	2016063PH
88200103	HARDNOSE-PRO	22" - 56 cm.	3/8"	0,063"	CHINESE 5200	223ATMK095	2216063PH
88200104	HARDNOSE-PRO	25" - 63 cm	3/8"	0,063"	STIHL 038-MS381	243ATMD025	2531063PH
88200105	HARDNOSE-PRO	36" - 90 cm.	.404"	0,063"	STIHL MS660	363ATMD025	
88200106	HARDNOSE-PRO	36" - 90 cm	.404"	0,063"	HU.288	363ATLD009	
88200108	HARDNOSE-PRO	28" - 71 cm	.404"	0,058"	HU.288	288ATMD009	
88200109	HARDNOSE-PRO	24" - 61 cm	.404"	0,058"	HU. 272XP	248ATMD009	
88200110	HARDNOSE-PRO	18" - 46 cm	3/8"	0,050"	STIHL MS180-250	180ATMA074	
88200116	HARDNOSE-PRO	20" - 50 cm	3/8"	0,058"	HU. 288		
88200117	HARDNOSE-PRO	20" - 50 cm	3/8"	0,058"	STIHL MS250		

## HEAVY DUTY CHAINSAW GUIDE BAR

UNIVERSAL

P&T PART NUMBER	TYPE	LENGTH	PITCH	GAUGE	MOUNT	OREGON CROSS REF.	CARLTON CROSS REF.
88200107HD	HEAVY DUTY HARDNOSE-PRO	30" - 76 CM.	.404"	0,063"	STIHL MS660	303ATMD025	
88200101HD	HEAVY DUTY HARDNOSE-PRO	36" - 90 CM.	.404"	0,063"	STIHL 070	363ATLE099	
88200112HD	HEAVY DUTY HARDNOSE-PRO	42" - 107 CM.	.404"	0,063"	STIHL 070	423ATLE086	



## SAW CHAIN IN REEL - 100 FEET

UNIVERSAL

OUR P/N	TYPE	PITCH	GAUGE	CUTTER VIEW	LENGTH	OREGON CROSS REF.	CARLTON CROSS REF.
88100101	CHIPPER CHAIN 4C-CP	.404"	0,063"		100 FEET 1480 LINKS	59AC	B3S
88100102	SEMI CHISEL 8A-SC	3/8"	0,050"		100 FEET 1640 LINKS	72DX	A1EP
88100103	CHISEL 4C-MC	.404"	0,063"		100 FEET 1480 LINKS	27	B3H
88100104	RIPPING 4C-RP	.404"	0,063"		100 FEET 1480 LINKS	27R	B3HR
88100105	CHISEL 8B-CH	3/8"	0,058"		100 FEET 1640 LINKS	73LPX	A2LM
88100106	SEMI CHISEL 9A-MC	3/8"LP	0,050"		100 FEET 1640 LINKS	91VXL	N1C
88100107	MICRO CHISEL 1A-MC	1/4"	0,050"		100 FEET 2392 LINKS	25AP	E1MC
88100108	MICRO CHISEL 5A-MC	0.325"	0,050"		100 FEET 1848 LINKS	20BPX	K1C
88100109	MICRO CHISEL 5C-MC	0.325"	0,063"		100 FEET 1848 LINKS	22BPX	K3C
88100122	CHISEL 8B-CH	3/8"	0,058"		100 FEET 1640 LINKS	75LPX	



## SAW CHAIN IN LOOP

UNIVERSAL

OUR P/N	TYPE	PITCH	GAUGE	CUTTER VIEW	LENGTH	OREGON CROSS REF.	CARLTON CROSS REF.
88100111	CHIPPER 4C-CP	.404"	0,063"		104 LINKS	59AC104G	B3S-104E
88100112	SEMI CHISEL 8A-SC	3/8"	0,050"		72 LINKS	72DX72G	A1EP-72E
88100113	SEMI CHISEL 8A-SC	3/8"	0,050"		76 LINKS	72DX76G	A1EP-76E
88100114	SEMI CHISEL 8A-SC	3/8"	0,050"		84 LINKS	72DX84G	A1EP-84E
88100115	MICRO CHISEL 4C-MC	.404"	0,063"		104 LINKS	27X104G	B3H-104E
88100116	RIPPING 4C-RP	.404"	0,063"		104 LINKS	27R104G	B3HR-104E
88100117	RIPPING 4C-RP	.404"	0,063"		92 LINKS	27R104G	B3H3-92E
88100118	MICRO CHISEL 4C-MC	.404"	0,063"		92 LINKS	27X104G	B3EP-92E
88100119	CHISEL 8C-CH	3/8"	0,063"		84 LINKS	75LPX	
88100120	CHISEL 8C-CH	3/8"	0,063"		114 LINKS	75LPX114G	
88100121	CHISEL 8C-CH	3/8"	0,063"		98 LINKS	75LPX98G	
88100123	CHISEL 8B-CH	3/8"	0,058"		84 LINKS	73LPX	

SAW CHAIN IN LOOP - SAW CHAIN IN REEL



## SPUR SPROCKET (NO BEARING INCLUDED)

SUITABLE FOR THE FOLLOWING CHAIN SAWS

MAKE FITS	DESCRIPTION	P/N	O.E.M. REF
<b>STIHL 070</b>	7TH - .404"	<b>88770661</b>	1106 640 2011
<b>STIHL 038M MS381-MS380</b>	7TH - 3/8"	<b>88770662</b>	1119 640 2000
<b>STIHL MS660</b>	7TH - 3/8"	<b>88770663</b>	1122 640 2002
<b>HUSQVARNA 365</b>	7TH - 3/8"	<b>88770664</b>	503 86 17-03

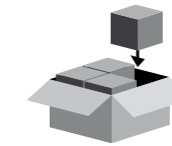

PACKAGING:	SINGLE BOX
Q.TY x MASTER PACK:	27 pcs
DIM. MASTER CARTON:	27 x 26 x 13 h cm
TOTAL WEIGHT:	7,7 kg
ORDER MULTIPLES OF:	27 pcs

## SPROCKET + RIM (NO BEARING INCLUDED)

SUITABLE FOR THE FOLLOWING CHAIN SAWS

MAKE FITS	DESCRIPTION	P/N	O.E.M. REF
<b>STIHL 070</b>	7TH - .404"	<b>88770665</b>	1106 640 2025
<b>STIHL 038M MS381-MS380</b>	7TH - 3/8"	<b>88770667</b>	1119 007 1003
<b>STIHL MS660 - 651 661</b>	7TH - 3/8"	<b>88770668</b>	1122 007 1000
<b>STIHL MS660 - 651 661</b>	7TH - .404"	<b>88770677 - C</b>	
<b>STIHL MS382</b>	7TH - 3/8"	<b>88770682</b>	1128 007 1000
<b>HUSQVARNA 365</b>	7TH - 3/8"	<b>88770669</b>	501 59 80-02
<b>HUSQVARNA 268-272XP</b>	7TH - 3/8"	<b>88770670 - C</b>	501 83 15-04
<b>VARIOUS MAKERS 4500 TO 5200 SERIE S</b>	7TH - .325"	<b>88770671</b>	



## SPROCKET + RIM (BEARING INCLUDED)

SUITABLE FOR THE FOLLOWING CHAIN SAWS

MAKE FITS	DESCRIPTION	P/N	O.E.M. REF
<b>STIHL MS250</b>	7TH - 0.325"	<b>88770680</b>	1123 007 1002
<b>STIHL MS310-390</b>	7TH - 3/8"	<b>88770679</b>	1125 007 1000
<b>STIHL MS660 - 651 661</b>	7TH - .404"	<b>88770677 - C</b>	
<b>HUSQVARNA 268-272XP</b>	7TH - 3/8"	<b>88770670 - C</b>	501 83 15-04

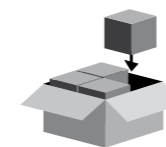

PACKAGING:	SINGLE BOX
Q.TY x MASTER PACK:	27 pcs
DIM. MASTER CARTON:	27 x 26 x 13 h cm
TOTAL WEIGHT:	7,7 kg
ORDER MULTIPLES OF:	27 pcs

## RIM SPROCKET

TYPE OF CHAIN	TEETH - PITCH	P/N
STANDARD	7 <sup>TH</sup> - .325" Small spline	<b>88770672</b>
STANDARD	7 <sup>TH</sup> - .3/8" Small spline	<b>88770673</b>
STANDARD	8 <sup>TH</sup> - .3/8"	<b>88770674</b>
STANDARD	7 <sup>TH</sup> - .3/8"	<b>88770675</b>
STANDARD	7 <sup>TH</sup> - .404"	<b>88770666</b>
STANDARD	8 <sup>TH</sup> - .404"	<b>88770676</b>

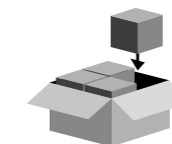

PACKAGING:	SINGLE BOX
Q.TY x MASTER PACK:	10 pcs
ORDER MULTIPLES OF:	10 pcs

RIM SPROCKET - SPROCKET + RIM - SPUR SPROCKET

COMBINATION WRENCH - TORX KEY

## TORX KEY

SUITABLE FOR THE FOLLOWING CHAIN SAWS

MAKE FITS	<b>STIHL 070</b>
TORX KEY 27 FOR STIHL SCREWS	P/N 882304072

PACKAGING:	<b>BULK</b>
Q.TY x MASTER PACK:	500 pcs
DIM. MASTER CARTON:	29 x 19 x h 24 cm
TOTAL WEIGHT:	8 kg
ORDER MULTIPLES OF:	<b>500 pcs</b>

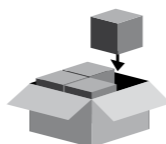

## COMBINATION WRENCH

SUITABLE FOR THE FOLLOWING CHAIN SAWS

DESCRIPTION	
SPANNER 19 MM TORX 27 STIHL	P/N 882304074

PACKAGING:	<b>BULK</b>
Q.TY x MASTER PACK:	100 pcs
DIM. MASTER CARTON:	29 x 19 x h 24 cm
TOTAL WEIGHT:	13 kg
ORDER MULTIPLES OF:	<b>100 pcs</b>

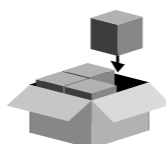

## COMBINATION WRENCH

SUITABLE FOR THE FOLLOWING CHAIN SAWS

DESCRIPTION	
T SPANNER TORX 27 FOR STIHL 070	P/N 882304075
T SPANNER TORX 25	P/N 882304076

T ALLEN KEY 3 mm	P/N 882304077
T ALLEN KEY 4 mm	P/N 882304098
T ALLEN KEY 5 mm	P/N 882304099

PACKAGING:	<b>BULK</b>
Q.TY x MASTER PACK:	100 pcs
DIM. MASTER CARTON:	29 x 19 x h 24 cm
TOTAL WEIGHT:	13 kg
ORDER MULTIPLES OF:	<b>100 pcs</b>

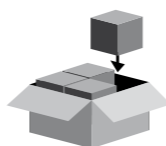

## COMBINATION WRENCH

SUITABLE FOR THE FOLLOWING CHAIN SAWS

MAKE FITS	P/N	P/N	MODEL	DIMENSION				
				A mm	B mm	C mm	BAR mm	PLUG mm
ALPINA	882304023	882304023K	A40-C40-CP45 A70-C70	150	52	33	13	19
CASTOR	882304096	882304096K	490-C90	150	34	34	17	19
DOLMAR	882304096	882304096K	122-123-144 152-153-133 166-309-310 311	150	34	34	17	19
	882304080	882304080K	112-113-114 116-117-119 120-120 super	150	25	25	13	19
ECHO	882304023	882304023K	C60-100-452 500-601-605 650-701-750 801-802	150	52	33	13	19
HUSQVARNA	882304023	882304023K	66-77 (2° mod.) 140-160-162 180-285-2100	150	52	33	13	19
	882304080	882304080K	61-154-181 234-266-44 444	150	25	25	13	19
JONSERED	882304080	882304080K	625-630-670	150	25	25	13	19
OLEO MAC	882304023	882304023K	254-350-355 592-930-931 938-941-942 945-946-947 950-951-956 962-970-971 980-981	150	52	33	13	19
	882304096	882304096K	271-272-481 482-999	150	34	34	17	19
PARTNER	882304023	882304023K	R16-R17-R18 S50-S55-P55 P70-P100	150	52	33	13	19
PIONEER	882304023	882304023K	P20-P21-P25 P26-P28-P40 P50-1200-1074 C55	150	52	33	13	19
	882304096	882304096K	P41-P51 Farmsaw P60	150	34	34	17	19
SOLO	882304023	882304023K	610-62-640 650	150	52	33	13	19
STIHL	882304010	882304010K	010-015-020 028-031-032 041	170	50	18	13	19
	882304096	882304096K	070 (magnetic type)-051	130	34	34	17	19
	882304000	882304000K	070 (magnetic type yellow)	150	34	34	17	19
	882304097	882304097K	MS660 (Torx 27)	170	34	34	13	19

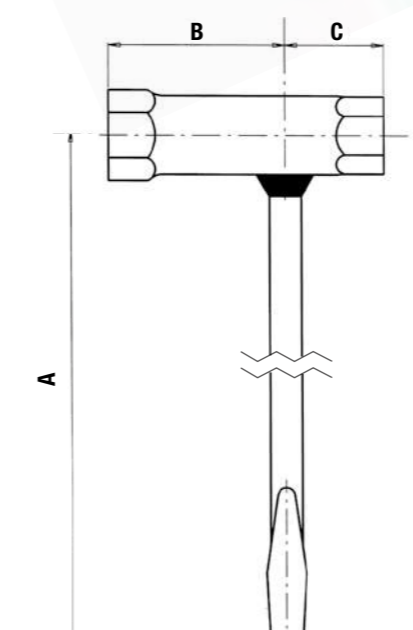

PACKAGING:	<b>BULK</b>
Q.TY x MASTER PACK:	100 pcs
DIM. MASTER CARTON:	29 x 19 x h 24 cm
TOTAL WEIGHT:	13 kg
ORDER MULTIPLES OF:	<b>100 pcs</b>

PACKAGING:	<b>BULK</b>
Q.TY x MASTER PACK:	100 pcs
DIM. MASTER CARTON:	44 x 26 x h 30 cm
TOTAL WEIGHT:	15 kg
ORDER MULTIPLES OF:	<b>100 pcs</b>

COMBINATION WRENCH



**P. & T. Srl**

Via Ruggiero Grieco, 34  
41011 Campogalliano (MO) - ITALY  
Tel/Fax +39 059 528 607  
[www.precisiontooling.eu](http://www.precisiontooling.eu)  
[info@ptspares.com](mailto:info@ptspares.com)

